



- MODIFICATION -			
REVISION	SIGNATURE	DATE	COMMENT
A	JSY	01/07/2021	FIRST ISSUE
B	JSY	05/01/2022	UP DATE SYNOPTIC CYCLOMIX EVO
C	JSY	06/03/2023	UP DATE LOGO SAMES

## TECHNICAL PROJECT FLUID

Name of machine or manufacturing installation :  <b>SCHEMA FLUIDE CYCLOMIX EVO</b> MNEMO:	NAME :	
	DATE :	
	TOTAL SHEETS <b>38</b>	MICROFILM
Destination : WORKSHOP:	Building:	SECTION      Project N°

Destination : WORKSHOP:		Building:	
COVER PAGE		MATRICULE	CLASSIFICATION
		SOFTWARE See V4R2 V4R3 SP17 (4.89.85)	
		<b>STANDARD</b> DIAGRAM N° : 800004970 // 055661855	
		SHEET 001 002 ▶	

This document is propriety of SAMES and must not be reproduced or diffused without permission

		<b>- MODIFICATIONS -</b>														
SHEET	DESIGNATION	Ind.	VISA	DATE	Ind.	VISA	DATE	Ind.	VISA	DATE	Ind.	VISA	DATE	Ind.	VISA	DATE
05	001	A	JSY	01/07/2021	B	JSY	05/01/2022									
	002	B	JSY	05/01/2022												
	004	A	JSY	01/07/2021												
	010	A	JSY	01/07/2021												
	011	A	JSY	01/07/2021												
	015	A	JSY	01/07/2021												
	018	A	JSY	01/07/2021												
	020	A	JSY	01/07/2021												
	021	A	JSY	01/07/2021	B	JSY	05/01/2022									
	022	A	JSY	01/07/2021	B	JSY	05/01/2022									
	030	A	JSY	01/07/2021												
	031	A	JSY	01/07/2021												
04	032	A	JSY	01/07/2021												
	033	A	JSY	01/07/2021												
	034	A	JSY	01/07/2021												
	040	A	JSY	01/07/2021												
	041	A	JSY	01/07/2021												
	042	A	JSY	01/07/2021												
	043	A	JSY	01/07/2021												
	044	A	JSY	01/07/2021												
	045	A	JSY	01/07/2021												
	071	A	JSY	01/07/2021												
	072	A	JSY	01/07/2021												
03	073	A	JSY	01/07/2021												
	074	A	JSY	01/07/2021												
	075	A	JSY	01/07/2021												
	081	A	JSY	01/07/2021												
	082	A	JSY	01/07/2021												
	083	A	JSY	01/07/2021												
	087	A	JSY	01/07/2021												
	090	A	JSY	01/07/2021												
	091	A	JSY	01/07/2021												
	097	A	JSY	01/07/2021												
	130	A	JSY	01/07/2021												
	131	A	JSY	01/07/2021												
	132	A	JSY	01/07/2021												
	133	A	JSY	01/07/2021												
	134	A	JSY	01/07/2021												
01																

LOCATION :

This document is propriety of SAMES and must not be reproduced or diffused without permission

01 02 03 04 05 06 07 08 09 10 11 12 13 14 15 16 17 18 19 20

LOCATION DESIGNATION

<i>BOOTH</i>	<i>BOOTH</i>
<i>CUST</i>	<i>CUSTOMER</i>
<i>CYCL_EVO</i>	<i>CYCLOMIX EVO PANEL</i>
<i>RC</i>	<i>REMOTE CONTROL</i>

<i>PROD_P</i>	<i>PRODUCT PLATE</i>
<i>SPRAY_BOX</i>	<i>SPRAYING BOX</i>
<i>CYCL_ADD_P</i>	<i>CYCLOMIX ADDITIONNAL CABINET</i>
<i>PROD_P_2K</i>	<i>PRODUCT PLATE_2K</i>
<i>PROD_P_3K</i>	<i>PRODUCT PLATE_3K</i>

05  
04  
03  
01

LOCATION :

This document is propriety of SAMES and must not be reproduced or diffused without permission

01 02 03 04 05 06 07 08 09 10 11 12 13 14 15 16 17 18 19 20

05

04

# CONFIG CYCLOMIX EVO

03

01

LOCATION :



REVISION A - MODIFICATIONS-  
SIGNATURE JSY C  
DATE 01/07/2021 06/03/2023

CONFIG CYCLOMIX EVO

**STANDARD**  
Project N° 800004970 // 055661855

SHEET  
010

◀ 004 011 ▶

This document is propriety of SAMES and must not be reproduced or diffused without permission

01 02 03 04 05 06 07 08 09 10 11 12 13 14 15 16 17 18 19 20

	TYPE	NB GUN	NB DUMP	NB FLUSHBOX	BLOCK 2 GUNS WITH FLUSH	SHEETS
1	2K	1				031 / 041 / 043 / 071 / 072 / 074 / 087
2	2K	1	1			031 / 041 / 043 / 071 / 072 / 074 / 082 / 087
3	2K	1	1	1		031 / 041 / 043 / 071 / 072 / 074 / 082 / 091
4	2K	1		1		031 / 041 / 043 / 071 / 072 / 074 / 091
5	2K	2				031 / 041 / 043 / 071 / 072 / 074 / 090
6	2K	2	1			031 / 041 / 043 / 071 / 072 / 074 / 082 / 090
7	2K	2	2			031 / 041 / 043 / 071 / 072 / 074 / 083 / 090
8	2K	2	1	2		031 / 041 / 043 / 071 / 072 / 074 / 082 / 091 / 097
9	2K	2	2	2		031 / 041 / 043 / 071 / 072 / 074 / 083 / 091 / 097
10	2K	2			1	031 / 041 / 043 / 071 / 072 / 074 / 081 / 090
11	2K	2	1		1	031 / 041 / 043 / 071 / 072 / 074 / 081 / 082 / 090
12	2K	2	2		1	031 / 041 / 043 / 071 / 072 / 074 / 081 / 083 / 090
13	2K	2	1	2	1	031 / 041 / 043 / 071 / 072 / 074 / 081 / 082 / 091 / 097
14	2K	2	2	2	1	031 / 041 / 043 / 071 / 072 / 074 / 081 / 083 / 091 / 097
15	3K	1	-			031 / 041 / 043 / 071 / 072 / 073 / 074 / 075 / 087
16	3K	1	1			031 / 041 / 043 / 071 / 072 / 073 / 074 / 075 / 082 / 087
17	3K	1	1	1		031 / 041 / 043 / 071 / 072 / 073 / 074 / 075 / 082 / 091
18	3K	1		1		031 / 041 / 043 / 071 / 072 / 073 / 074 / 075 / 091
19	3K	2				031 / 041 / 043 / 071 / 072 / 073 / 074 / 075 / 090
20	3K	2	1			031 / 041 / 043 / 071 / 072 / 073 / 074 / 075 / 082 / 090
21	3K	2	2			031 / 041 / 043 / 071 / 072 / 073 / 074 / 075 / 083 / 090
22	3K	2	1	2		031 / 041 / 043 / 071 / 072 / 073 / 074 / 075 / 082 / 091 / 097
23	3K	2	2	2		031 / 041 / 043 / 071 / 072 / 073 / 074 / 075 / 083 / 091 / 097
24	3K	2			1	031 / 041 / 043 / 071 / 072 / 073 / 074 / 075 / 081 / 090
25	3K	2	1		1	031 / 041 / 043 / 071 / 072 / 073 / 074 / 075 / 081 / 082 / 090
26	3K	2	2		1	031 / 041 / 043 / 071 / 072 / 073 / 074 / 075 / 081 / 083 / 090
27	3K	2	1	2	1	031 / 041 / 043 / 071 / 072 / 073 / 074 / 075 / 081 / 082 / 091 / 097
28	3K	2	2	2	1	031 / 041 / 043 / 071 / 072 / 073 / 074 / 075 / 081 / 083 / 091 / 097
29						
30						
31						
32						
33						
34						
35						

LOCATION :



REVISION A  
SIGNATURE JSY  
DATE 01/07/2021

- MODIFICATIONS-

CONFIG CYCLOMIX EVO

**STANDARD**  
Project N° 800004970 // 055661855

SHEET 011  
◀ 010 015 ▶

This document is propriety of SAMES and must not be reproduced or diffused without permission

01 02 03 04 05 06 07 08 09 10 11 12 13 14 15 16 17 18 19 20

05

04

03

# LAYOUT STATION

01

LOCATION :



REVISION A  
SIGNATURE JSY  
DATE 01/07/2021

- MODIFICATIONS -

LAYOUT STATION

**STANDARD**

Project N° 800004970 // 055661855

SHEET  
015

◀ 011

018 ▶

This document is propriety of SAMES and must not be reproduced or diffused without permission

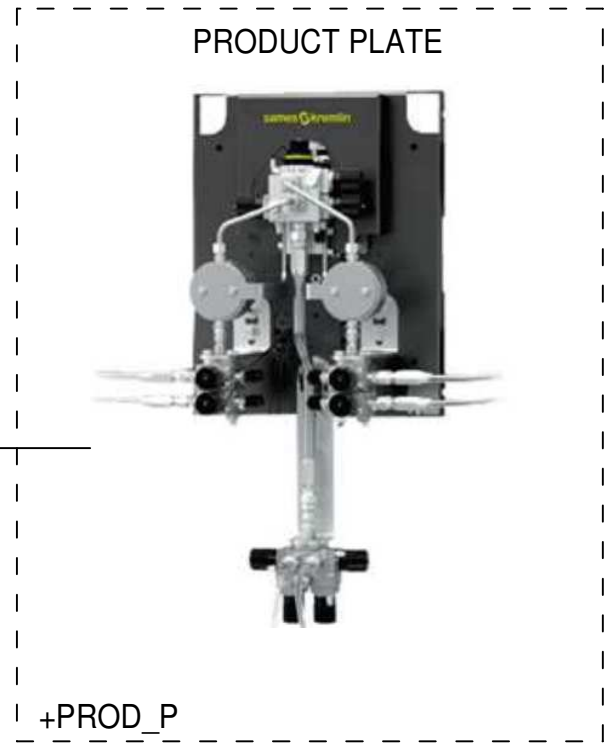
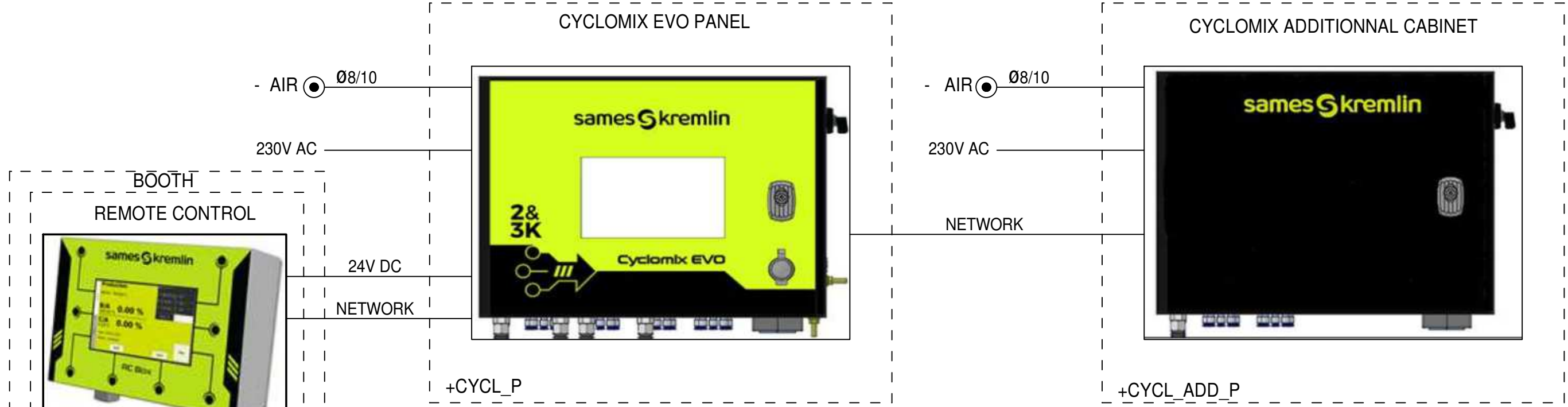

LOCATION :

This document is propriety of SAMES and must not be reproduced or diffused without permission

01 02 03 04 05 06 07 08 09 10 11 12 13 14 15 16 17 18 19 20

05

04

# SYNOPTIC CYCLOMIX EVO

03

01

LOCATION :



REVISION A	- MODIFICATIONS-
SIGNATURE JSY	C
DATE 01/07/2021	JSY 06/03/2023

SYNOPTIC CYCLOMIX EVO

**STANDARD**  
Project N° 800004970 // 055661855

SHEET  
020

◀ 018 021 ▶



This document is propriety of SAMES and must not be reproduced or diffused without permission

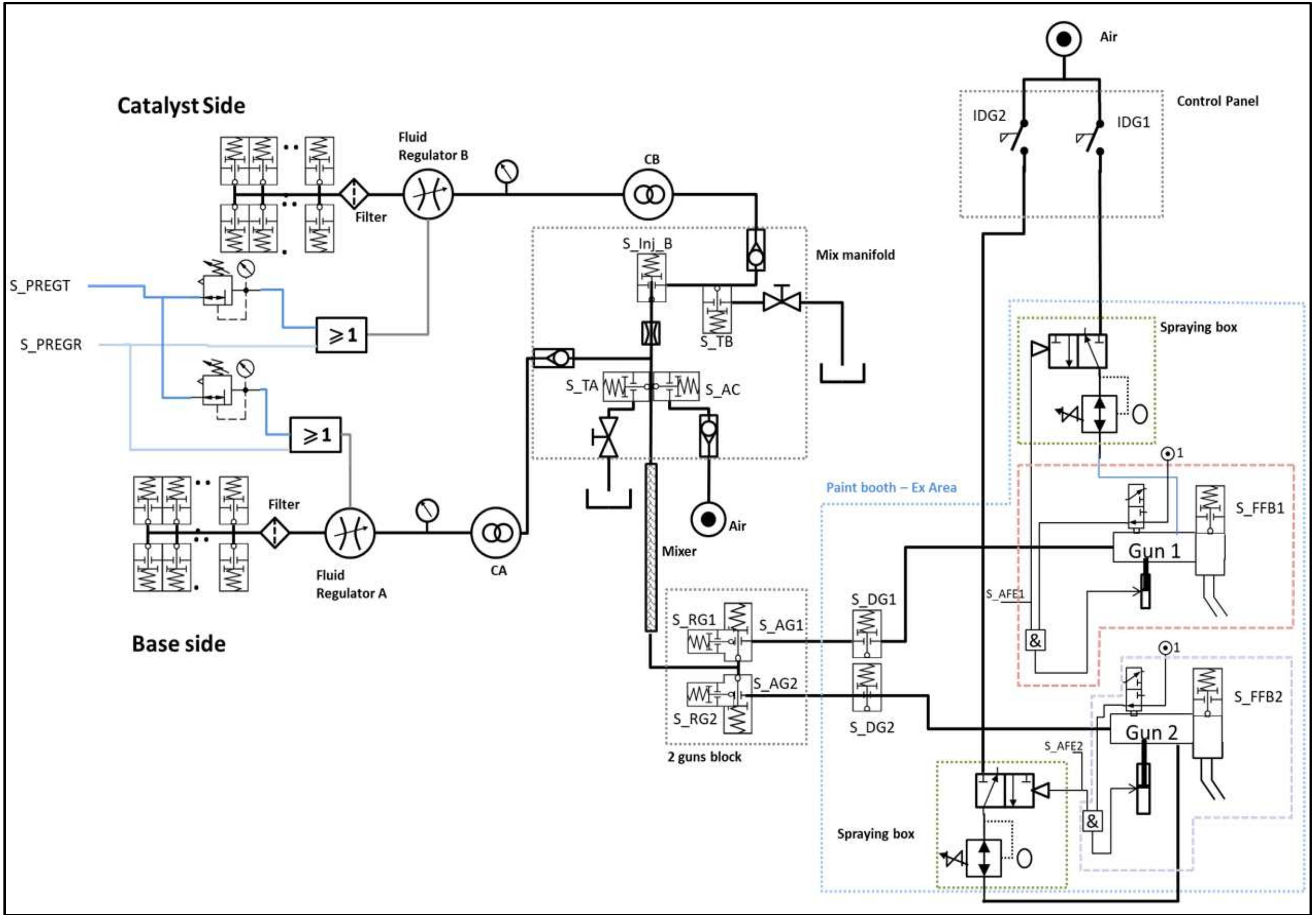

LOCATION :

This document is propriety of SAMES and must not be reproduced or diffused without permission

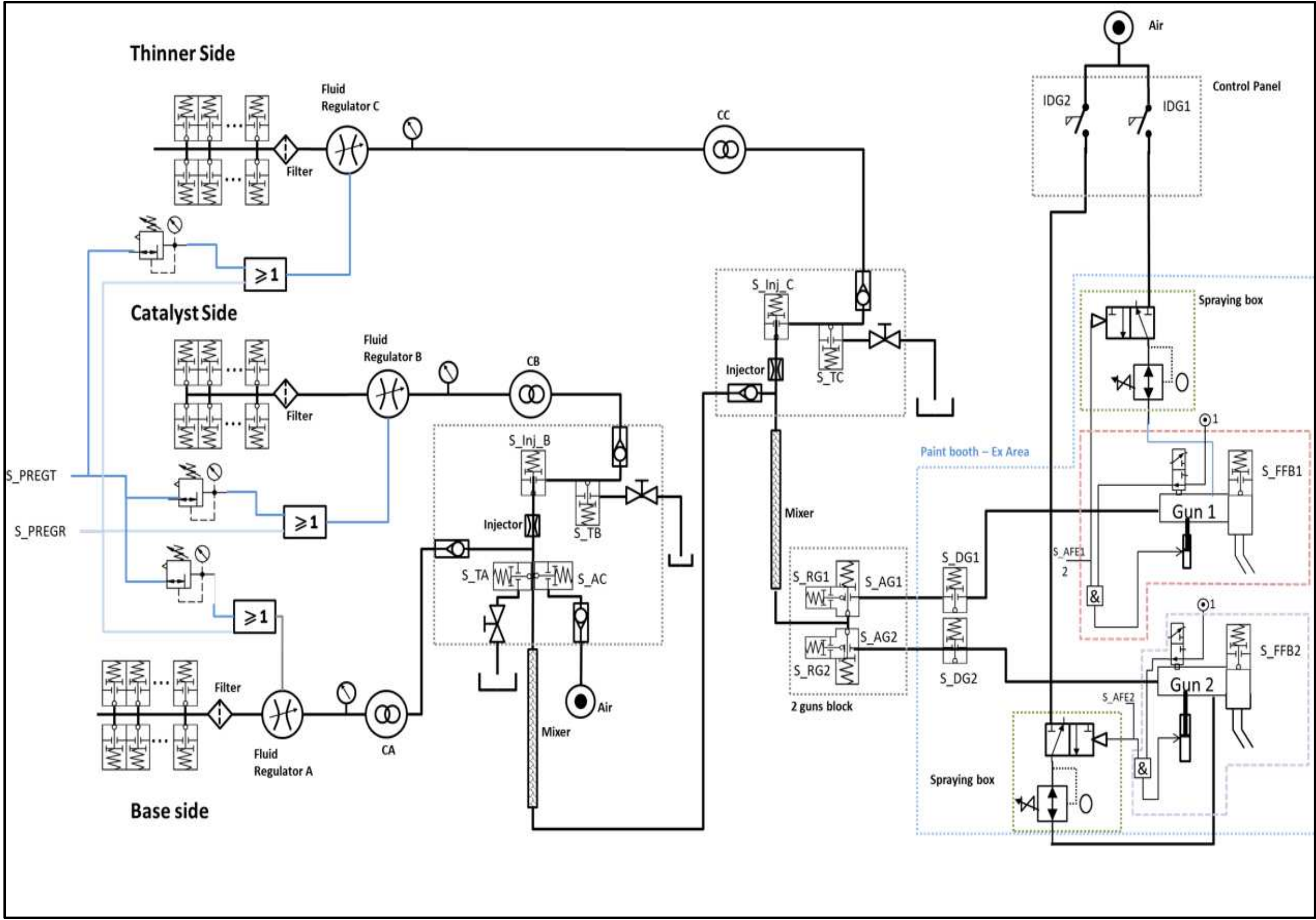

LOCATION :

This document is propriety of SAMES and must not be reproduced or diffused without permission

01 02 03 04 05 06 07 08 09 10 11 12 13 14 15 16 17 18 19 20

05

04

# VALVES BLOCKS

03

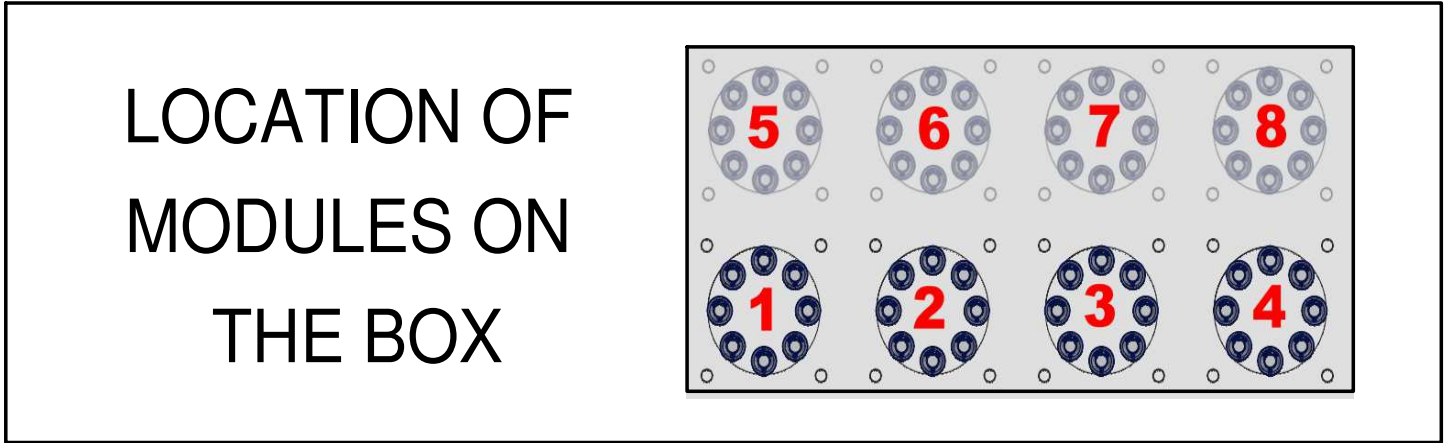

01

LOCATION :

This document is propriety of SAMES and must not be reproduced or diffused without permission

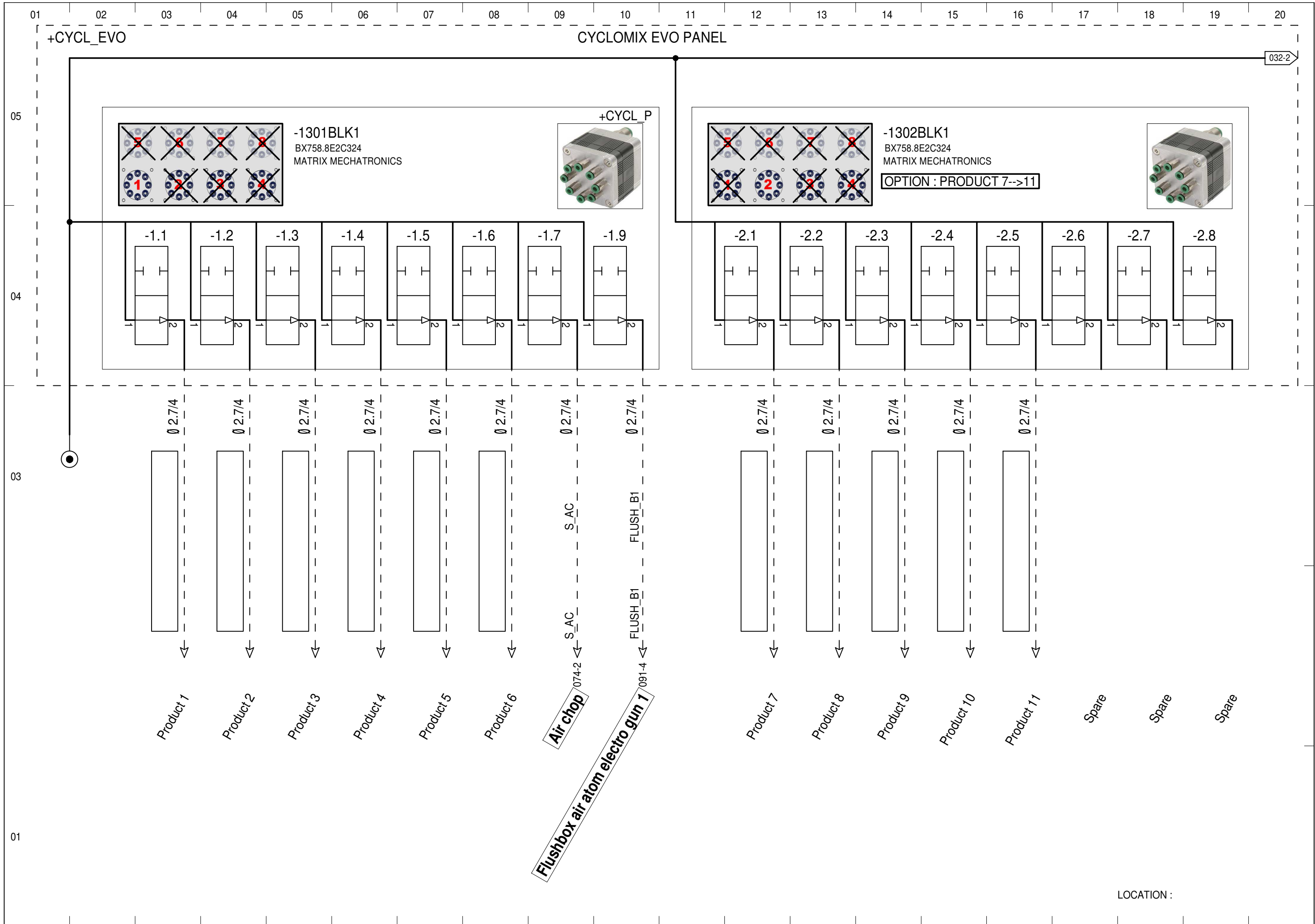

LOCATION :

This document is propriety of SAMES and must not be reproduced or diffused without permission

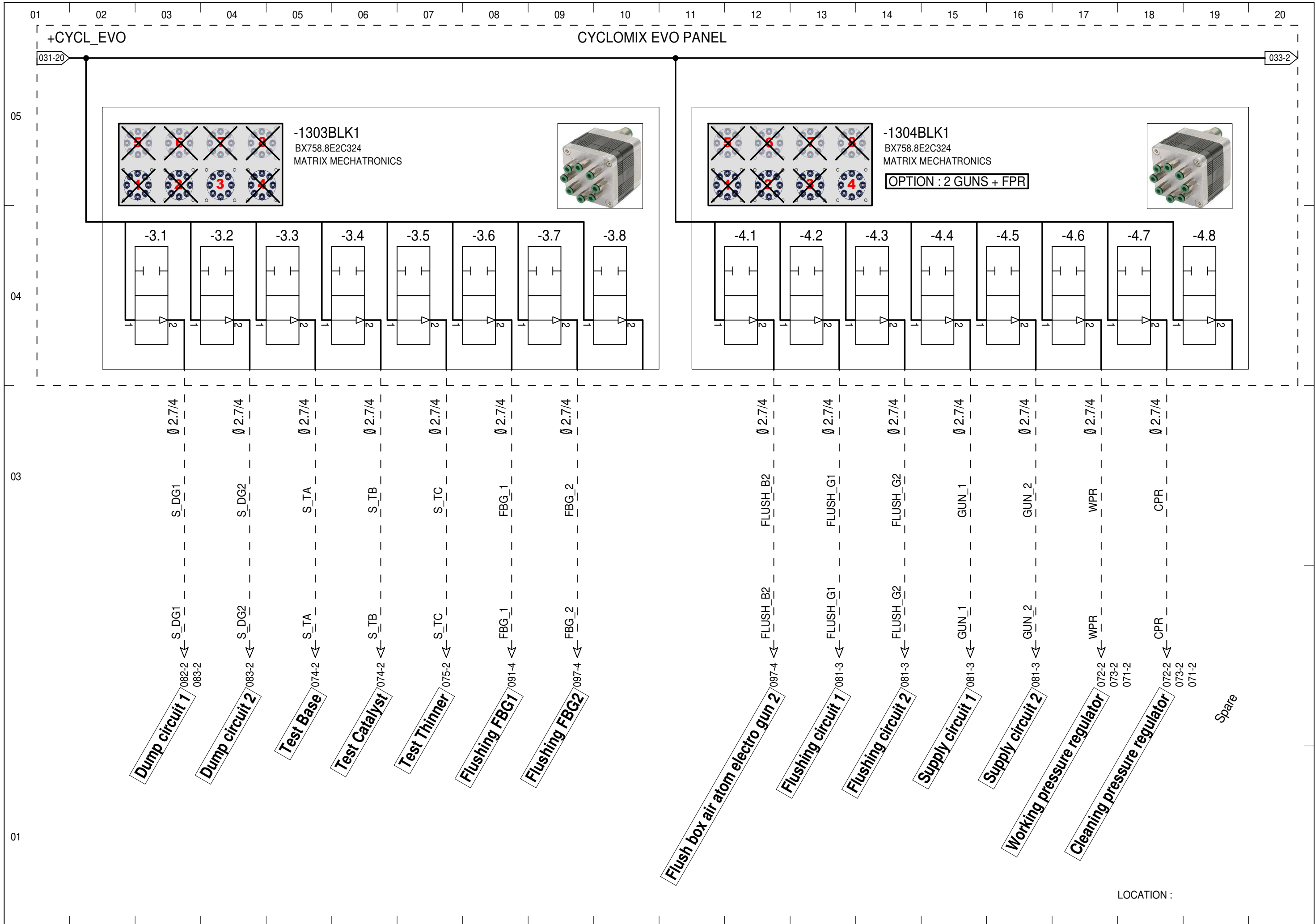

LOCATION :

This document is propriety of SAMES and must not be reproduced or diffused without permission

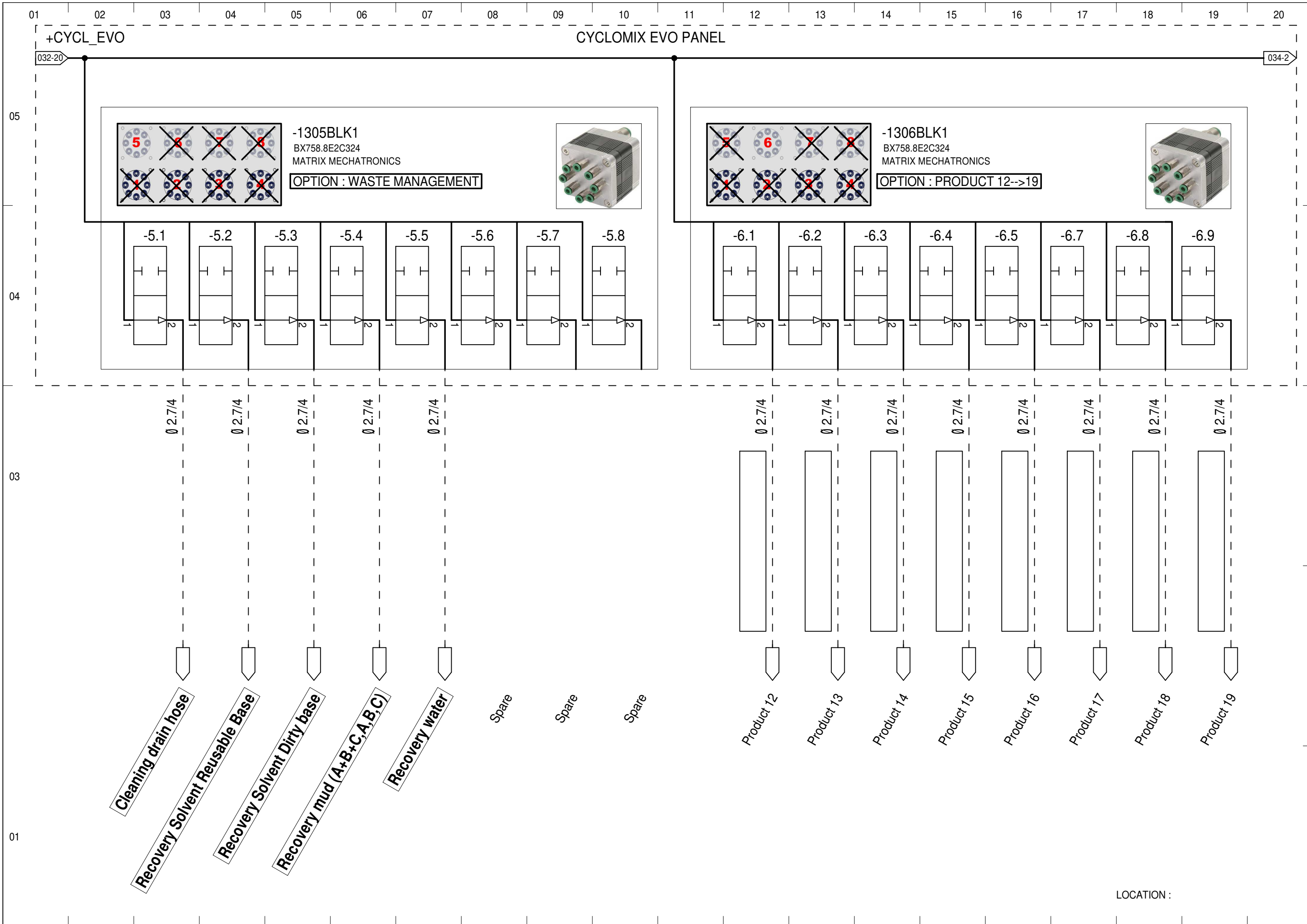

LOCATION :

This document is propriety of SAMES and must not be reproduced or diffused without permission

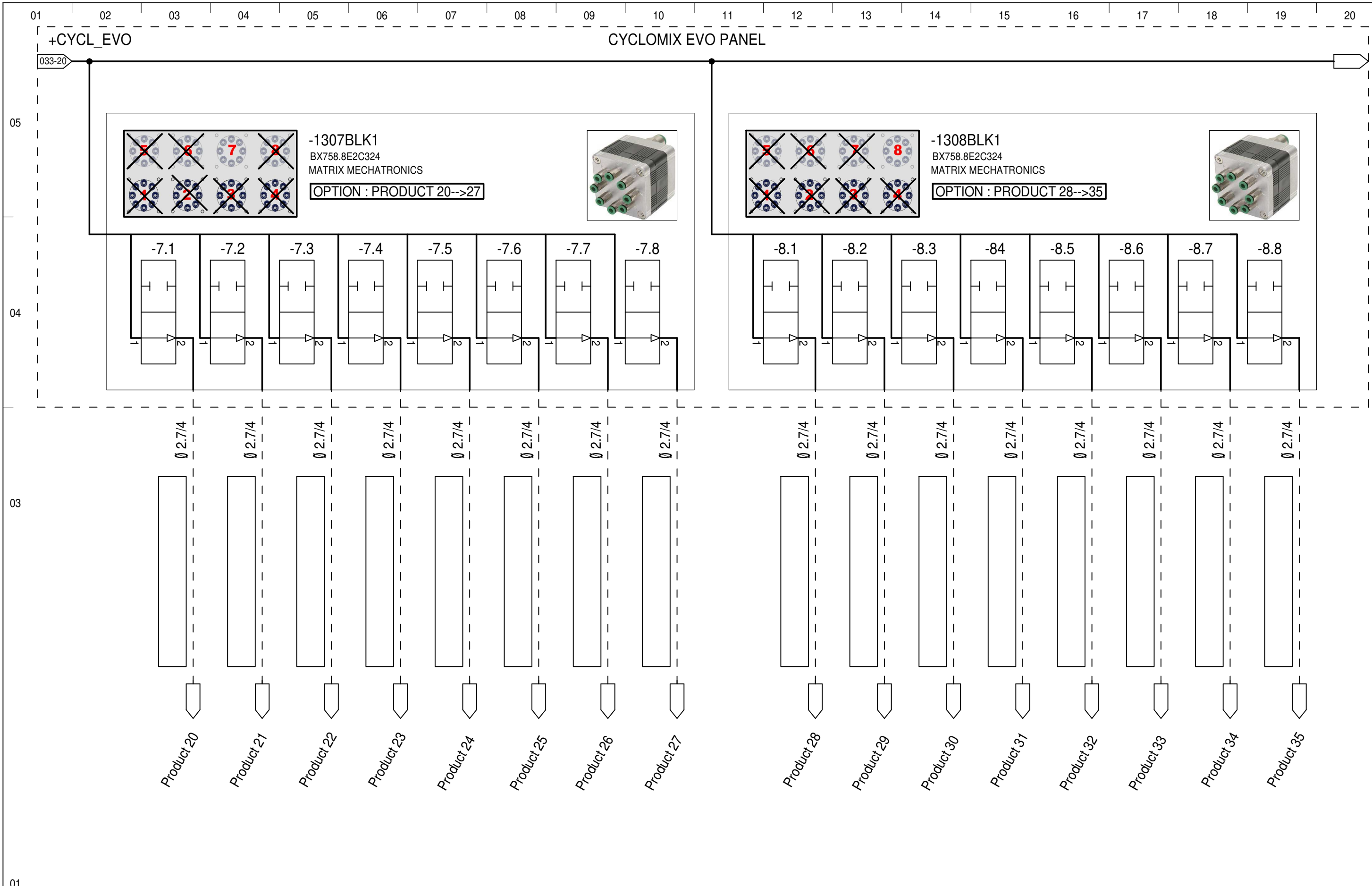

+CYCL\_EVO

### CYCLOMIX EVO PANEL

033-20

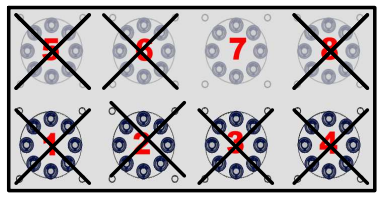

-1307BLK1  
 BX758.8E2C324  
 MATRIX MECHATRONICS

OPTION : PRODUCT 20-->27

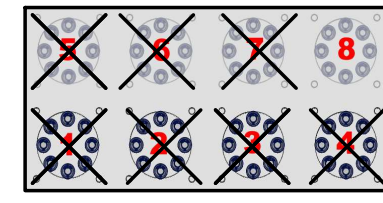

-1308BLK1  
 BX758.8E2C324  
 MATRIX MECHATRONICS

OPTION : PRODUCT 28-->35



LOCATION :

This document is propriety of SAMES and must not be reproduced or diffused without permission

01 02 03 04 05 06 07 08 09 10 11 12 13 14 15 16 17 18 19 20

05

04

03

01

**COMP.A**

LOCATION :



REVISION A  
SIGNATURE JSY  
DATE 01/07/2021

- MODIFICATIONS -

BASE SIDE

**STANDARD**  
Project N° 800004970 // 055661855

SHEET  
040  
◀ 034 041 ▶



This document is propriety of SAMES and must not be reproduced or diffused without permission

01 02 03 04 05 06 07 08 09 10 11 12 13 14 15 16 17 18 19 20

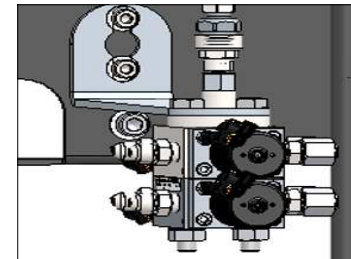
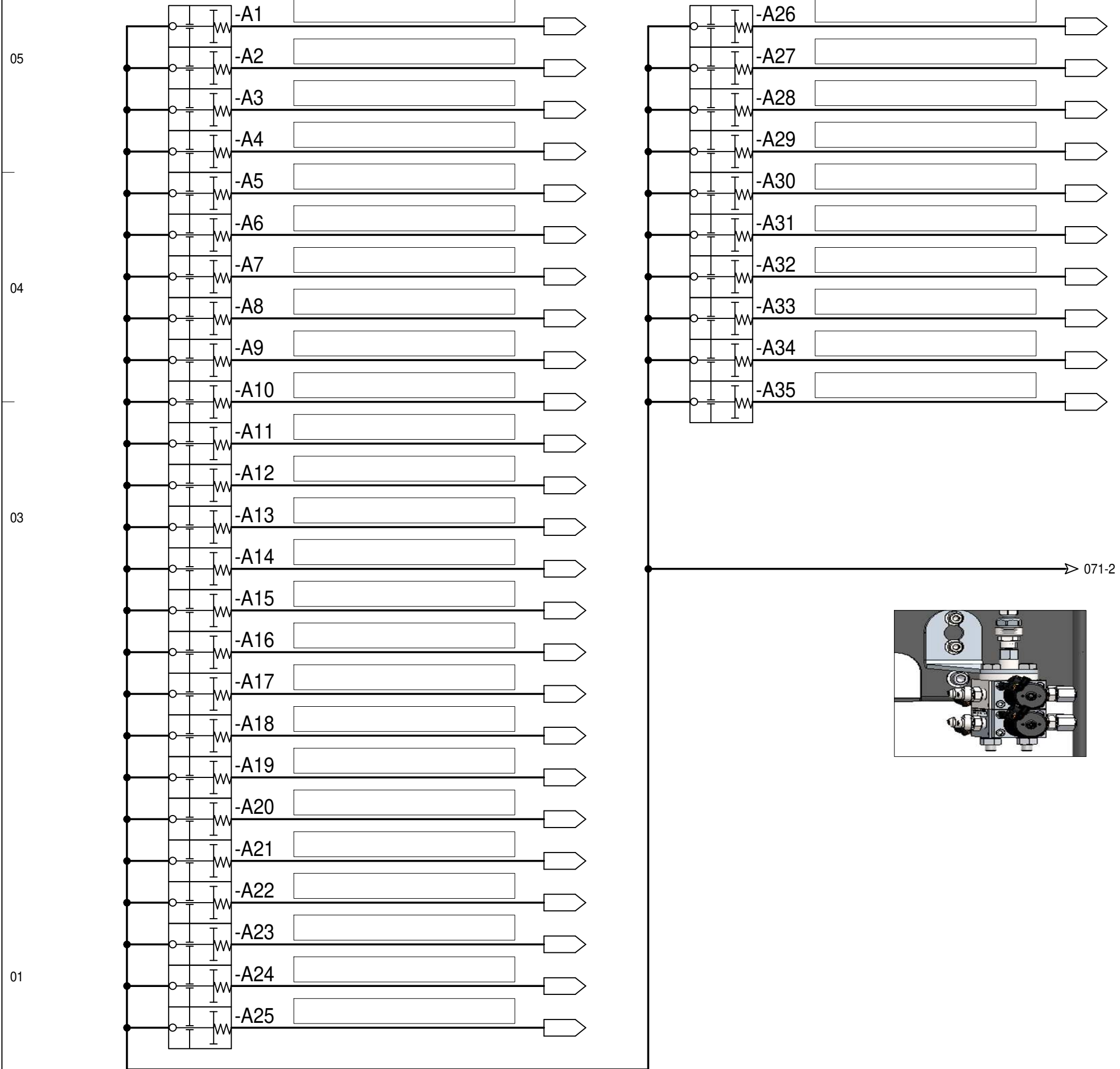

LOCATION : PROD\_P

This document is propriety of SAMES and must not be reproduced or diffused without permission

01 02 03 04 05 06 07 08 09 10 11 12 13 14 15 16 17 18 19 20

05

04

03

# CATALYST SIDE

01

LOCATION :

This document is propriety of SAMES and must not be reproduced or diffused without permission

01 02 03 04 05 06 07 08 09 10 11 12 13 14 15 16 17 18 19 20

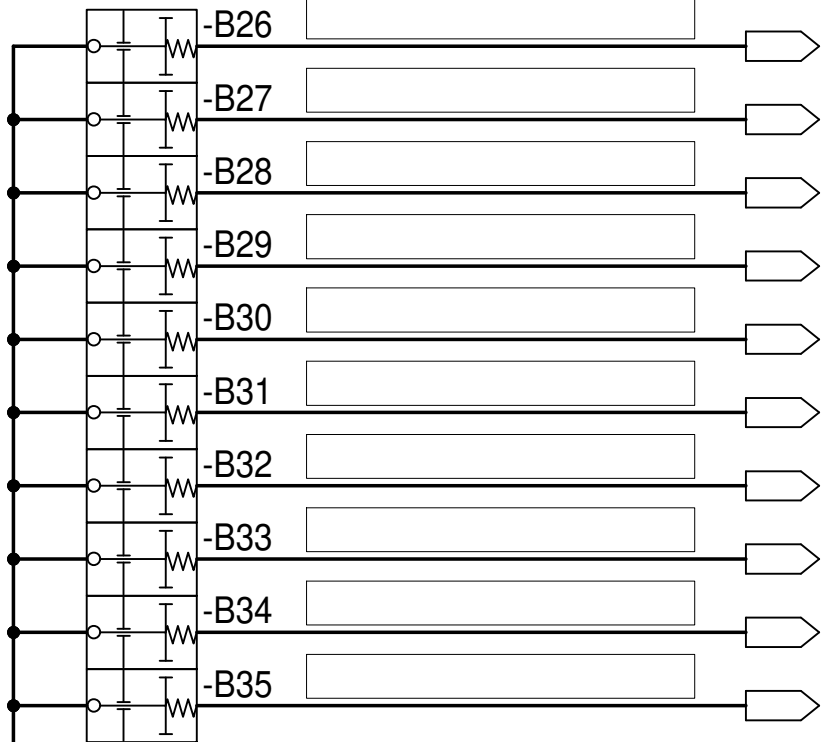
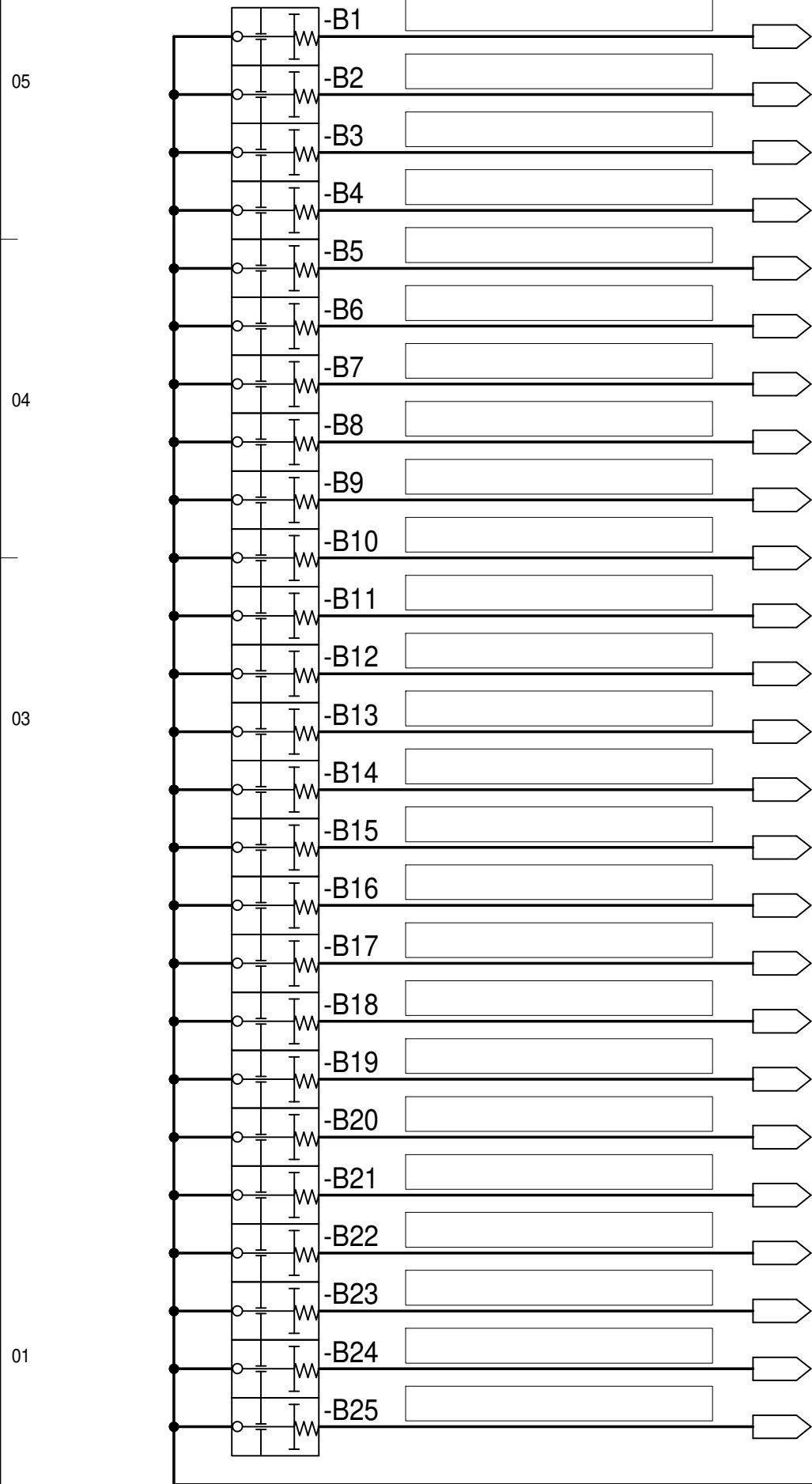

072-2  
FB

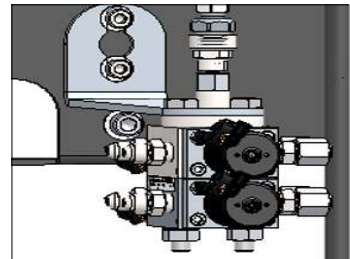

LOCATION : PROD\_P

This document is propriety of SAMES and must not be reproduced or diffused without permission

01 02 03 04 05 06 07 08 09 10 11 12 13 14 15 16 17 18 19 20

05

04

03

01

**THINNER SIDE**

LOCATION :

This document is propriety of SAMES and must not be reproduced or diffused without permission

01 02 03 04 05 06 07 08 09 10 11 12 13 14 15 16 17 18 19 20

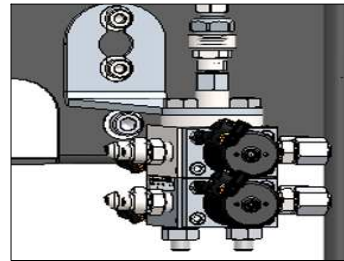
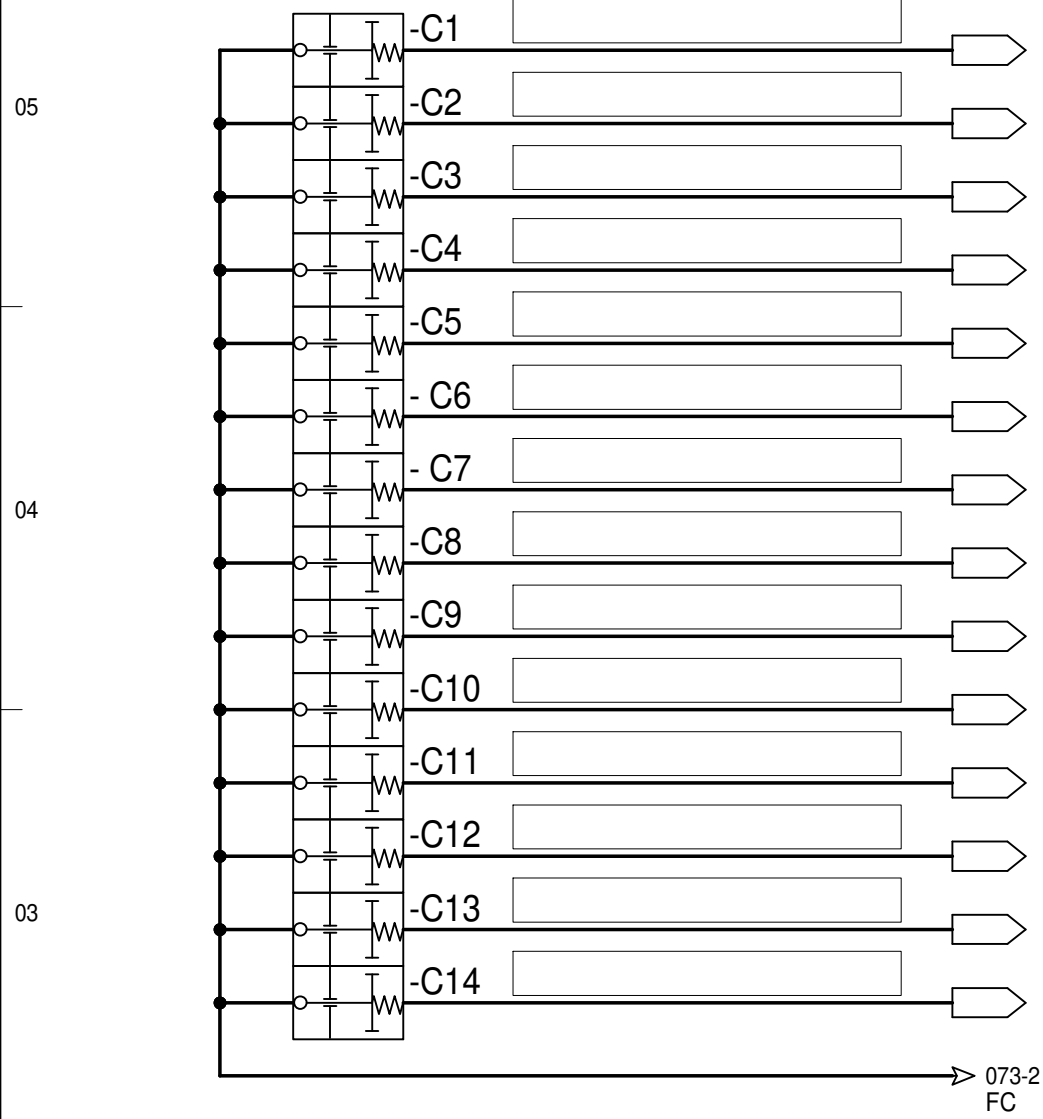

01

LOCATION : PROD\_P

This document is property of SAMES and must not be reproduced or diffused without permission

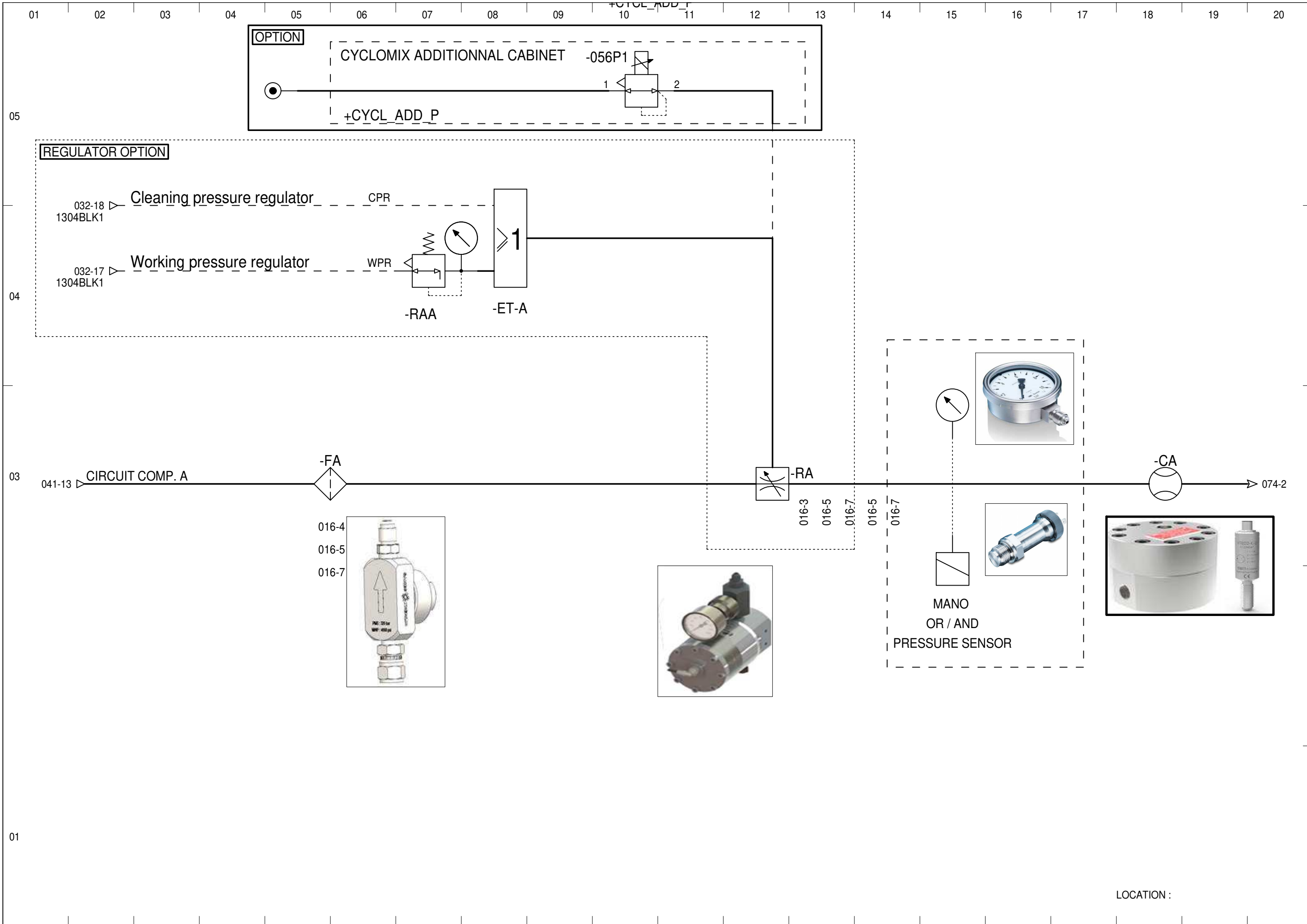

LOCATION :

This document is property of SAMES and must not be reproduced or diffused without permission

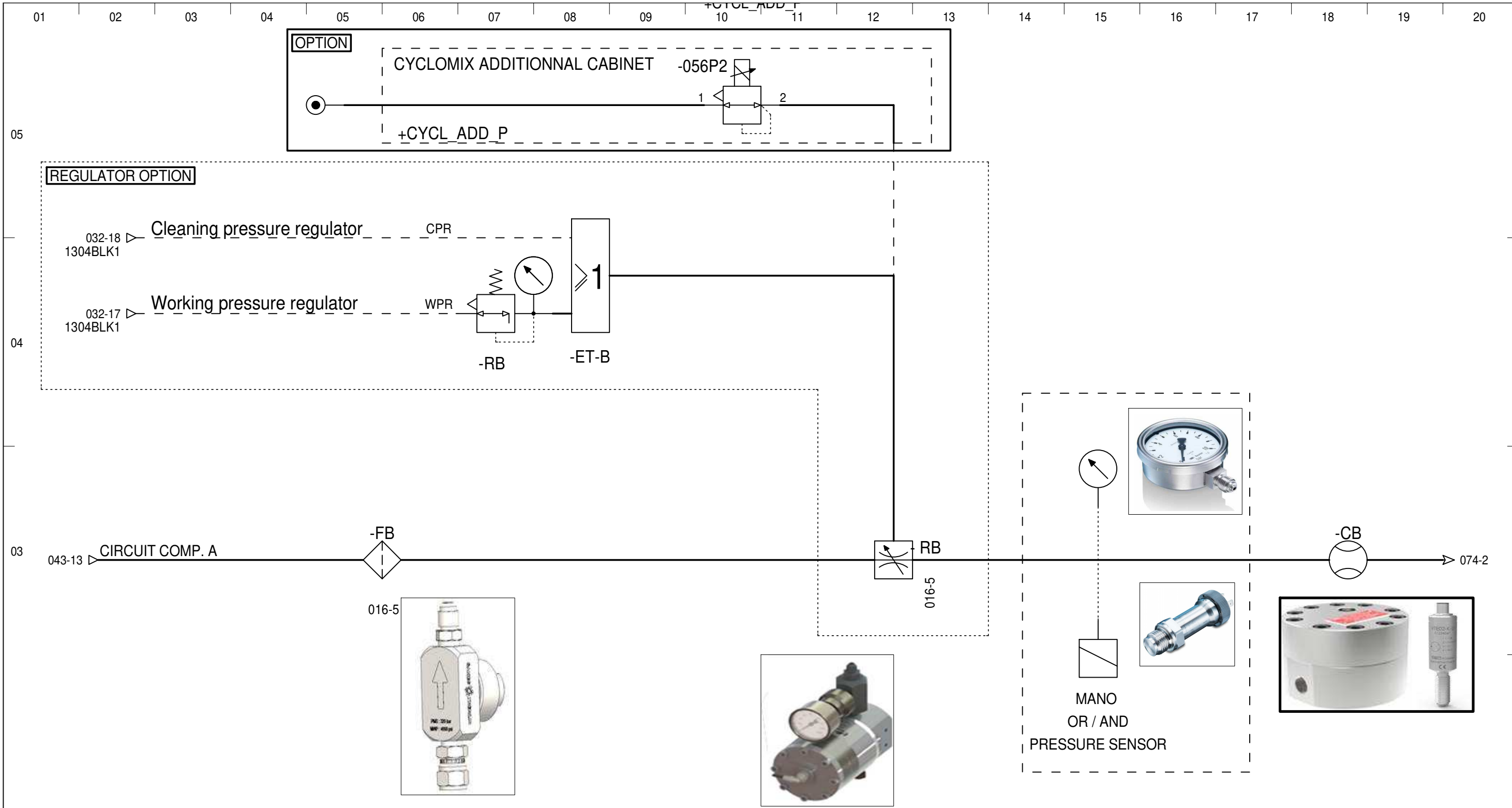

OPTION REGULATOR

LOCATION :

This document is propriety of SAMES and must not be reproduced or diffused without permission

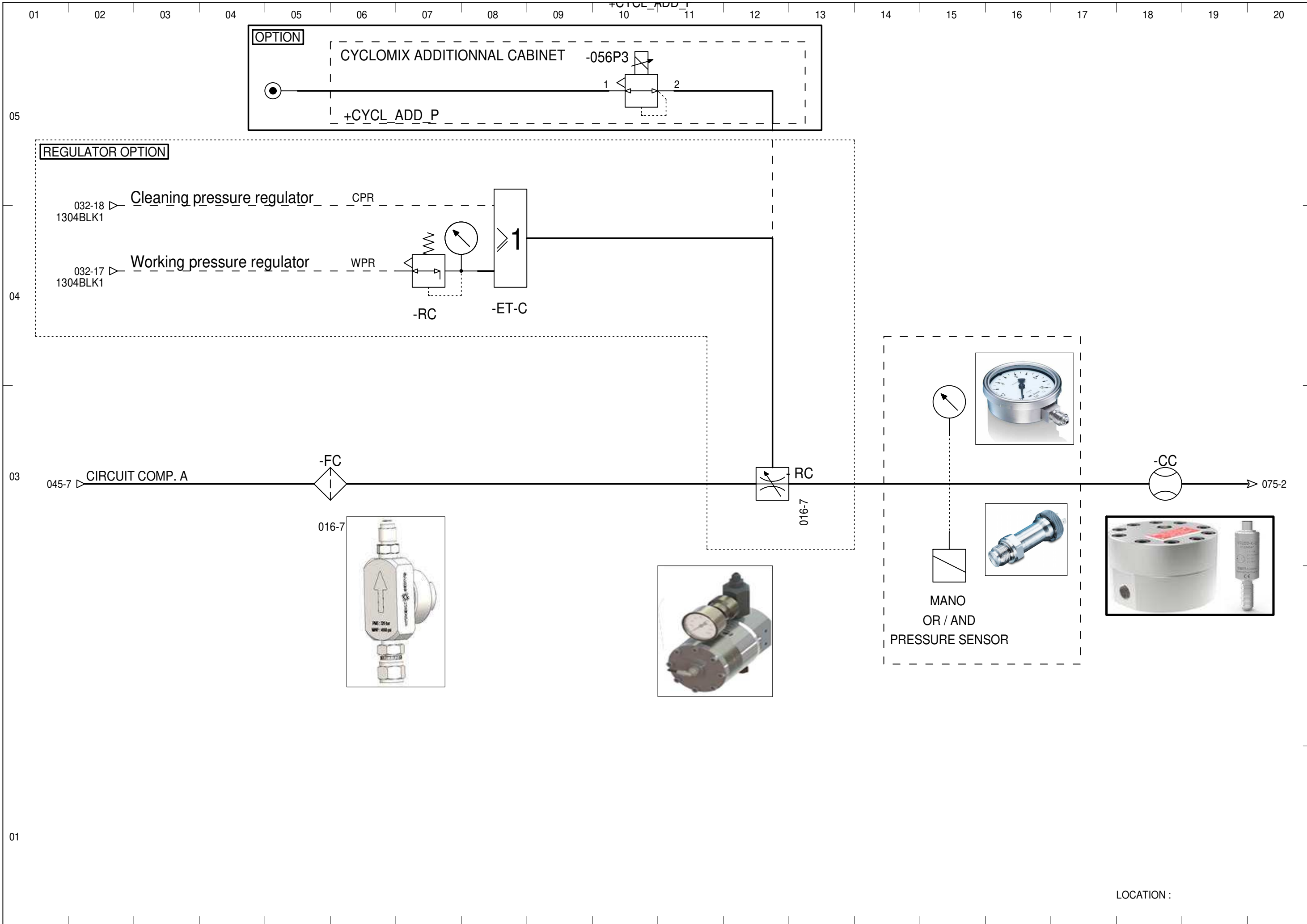

LOCATION :



This document is propriety of SAMES and must not be reproduced or diffused without permission

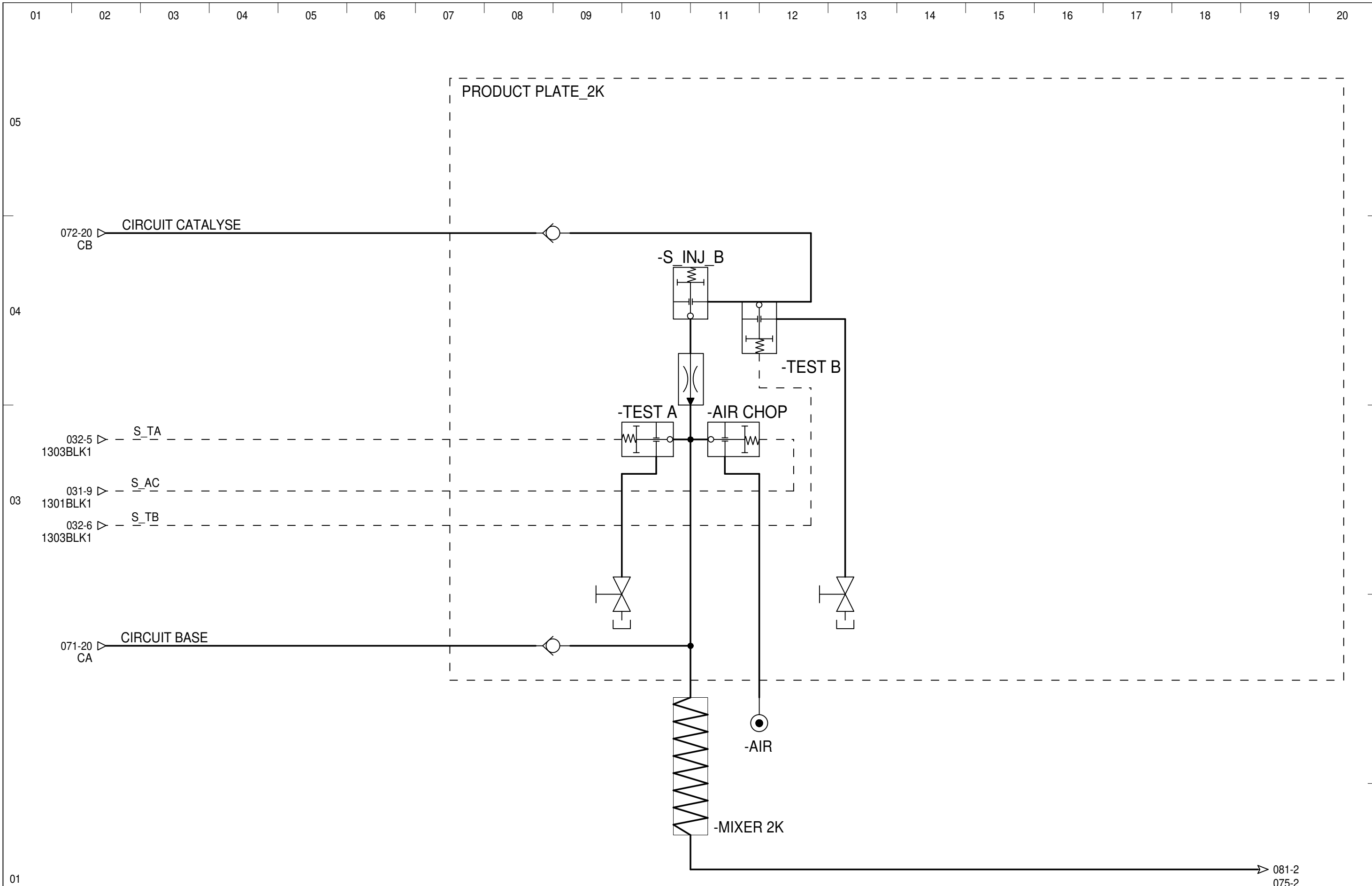

LOCATION :

This document is propriety of SAMES and must not be reproduced or diffused without permission

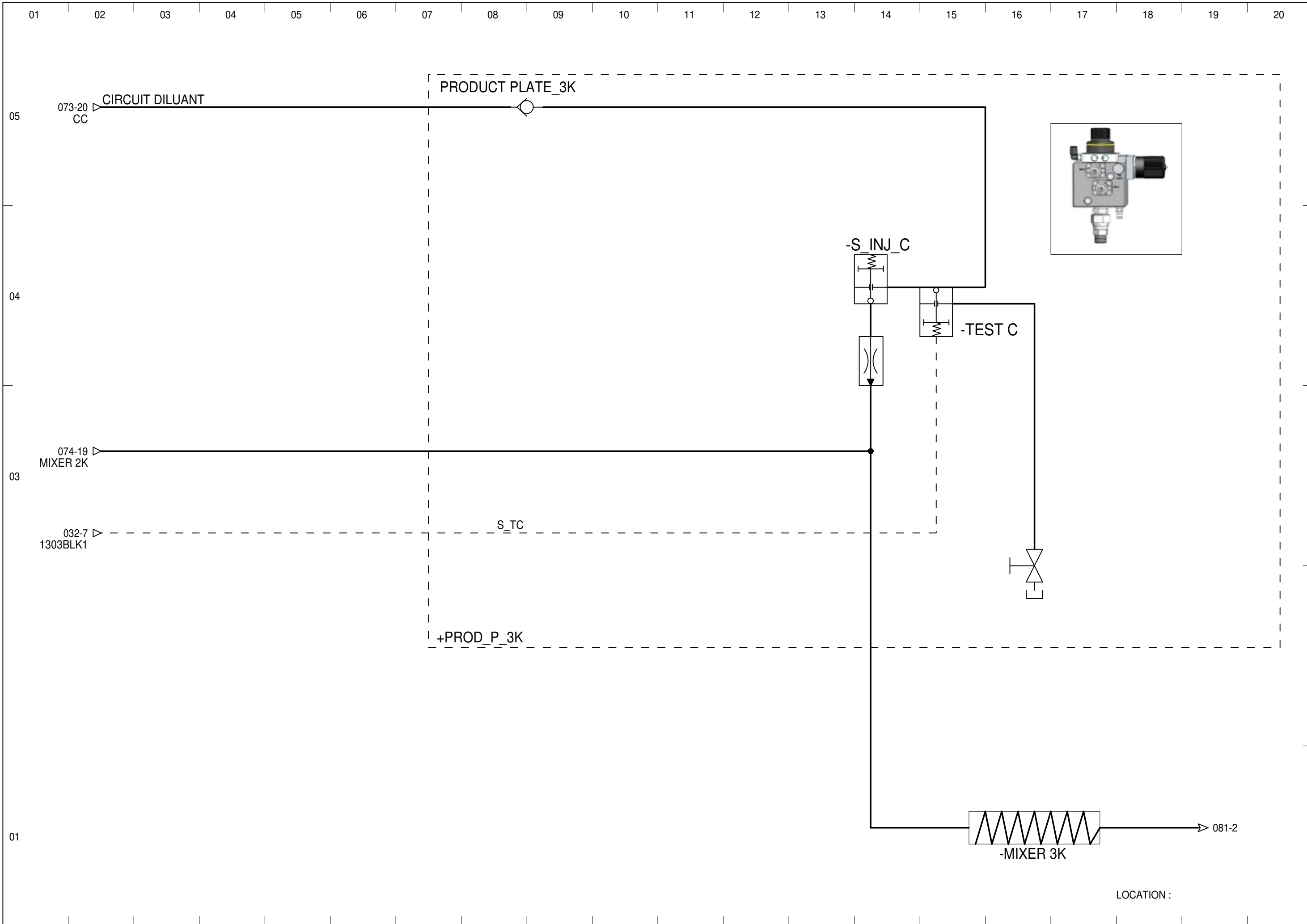

LOCATION :

This document is propriety of SAMES and must not be reproduced or diffused without permission

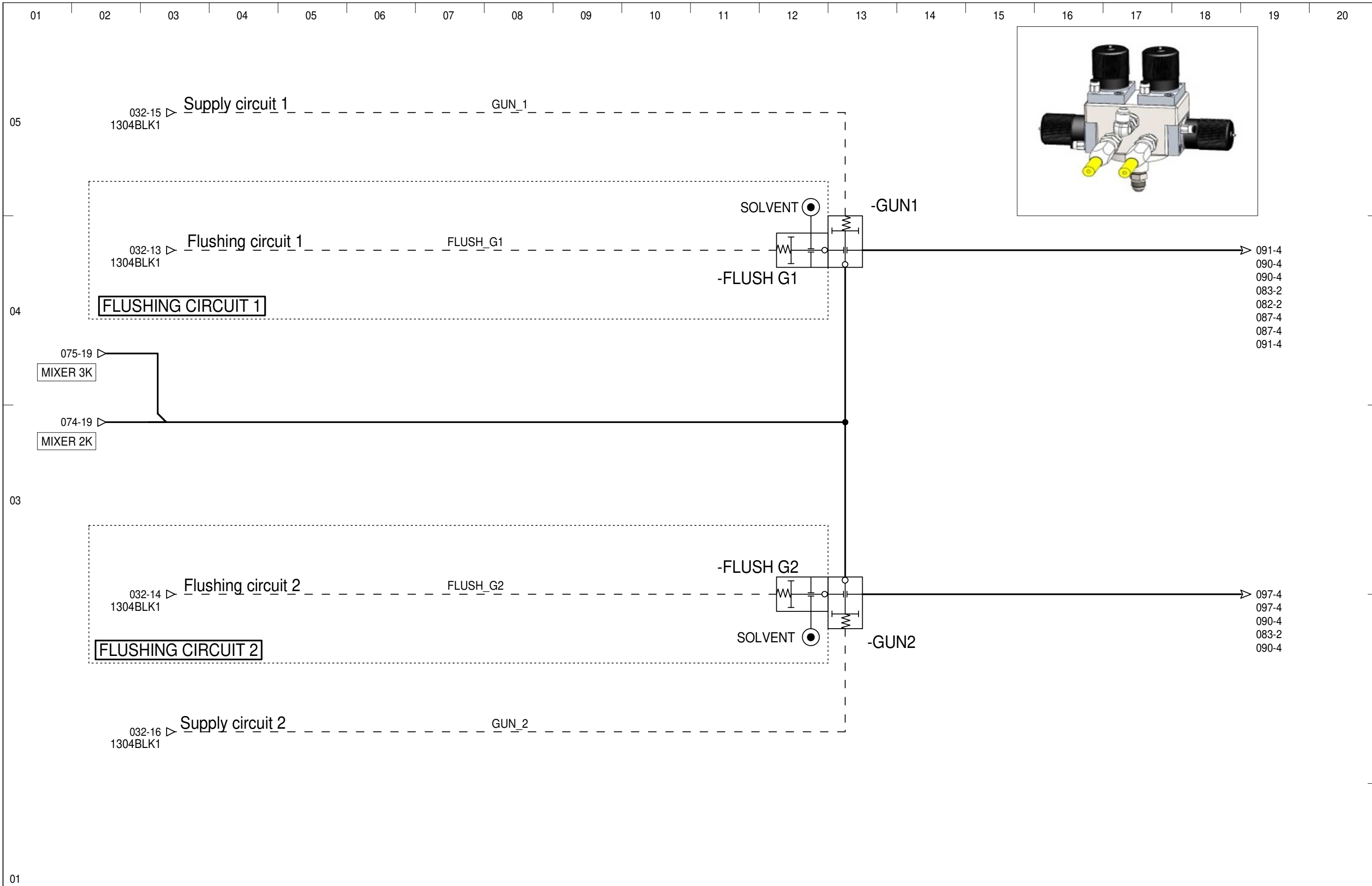

LOCATION :

This document is propriety of SAMES and must not be reproduced or diffused without permission

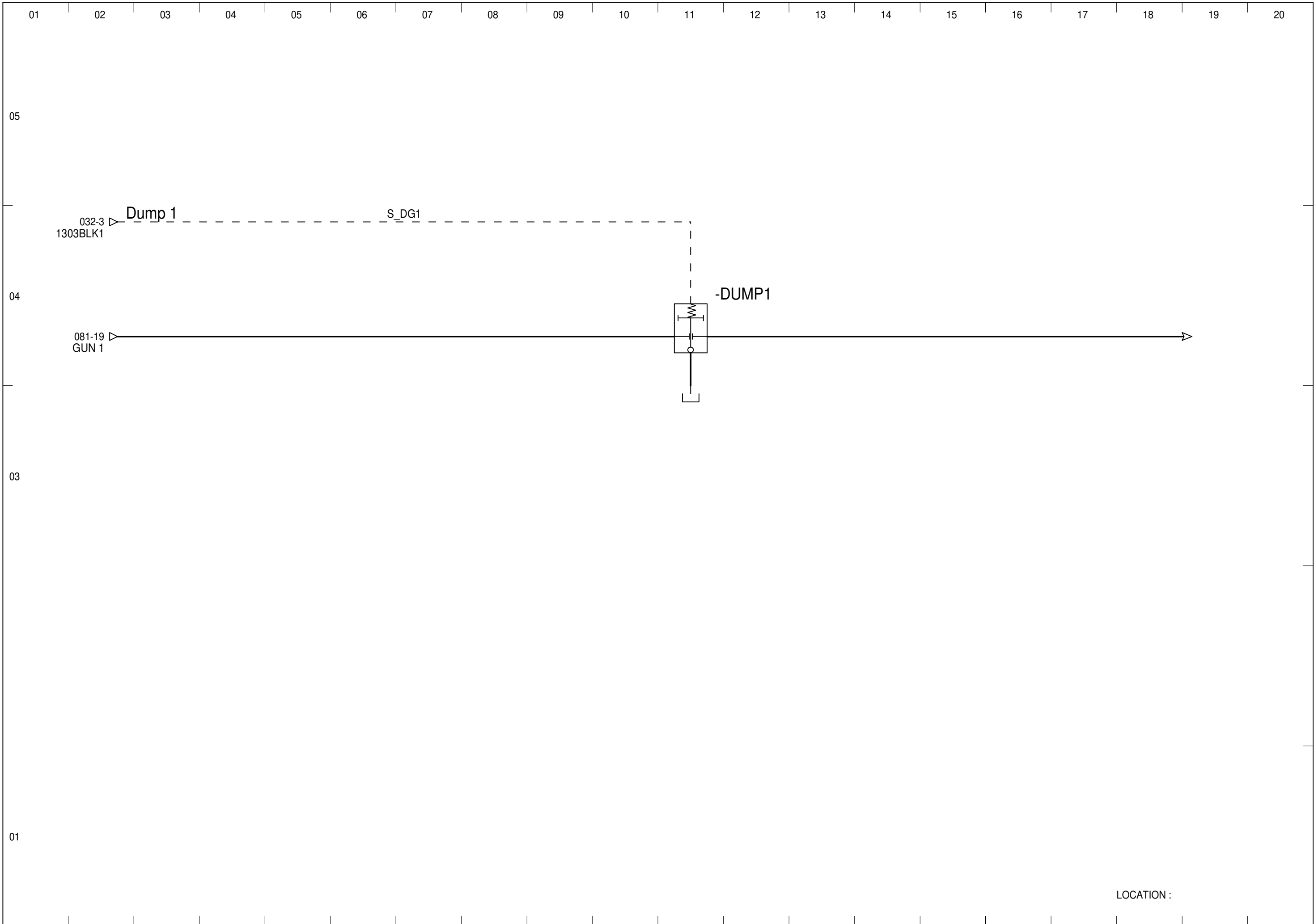

LOCATION :

This document is propriety of SAMES and must not be reproduced or diffused without permission

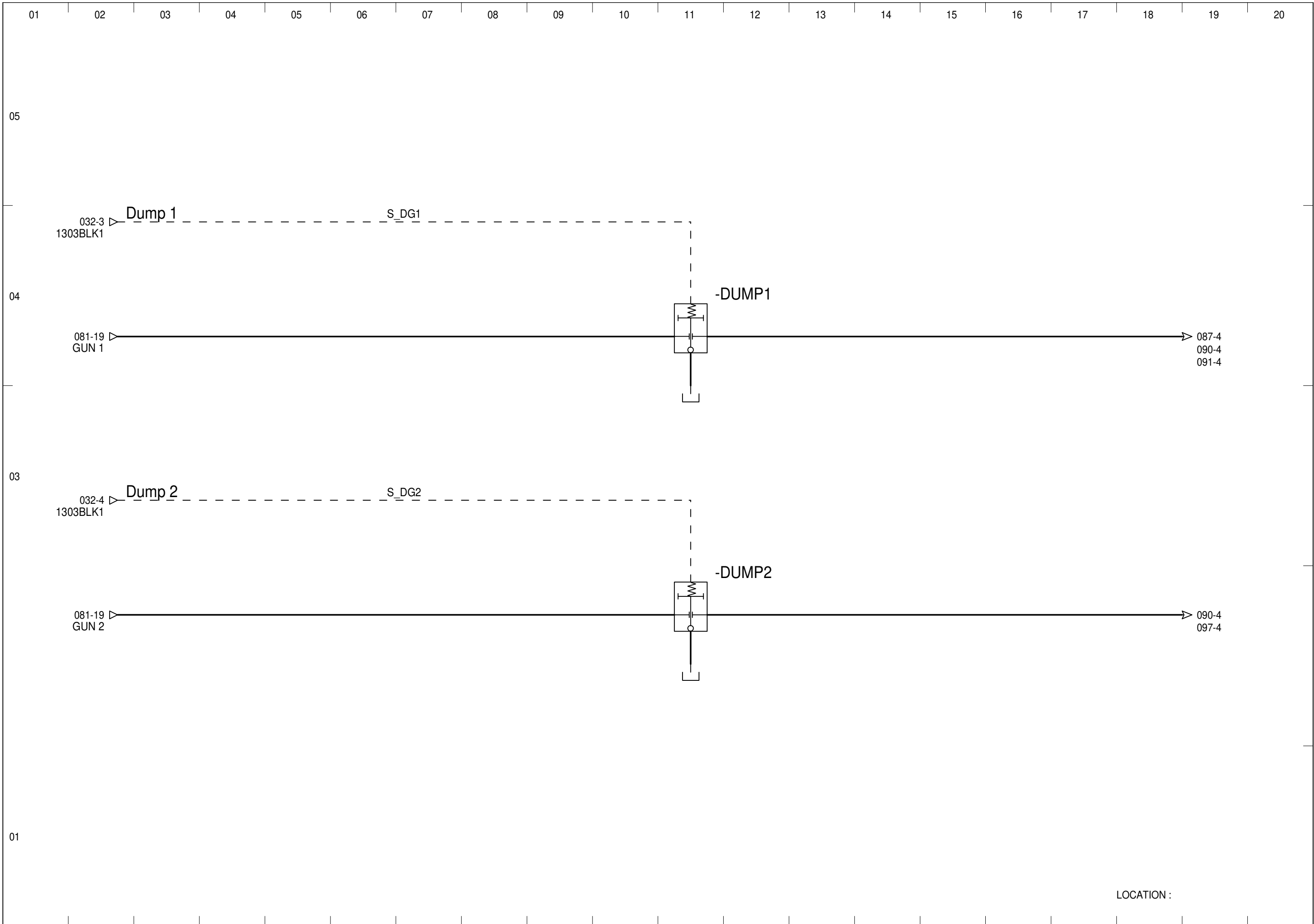

LOCATION :

This document is propriety of SAMES and must not be reproduced or diffused without permission

01 02 03 04 05 06 07 08 09 10 11 12 13 14 15 16 17 18 19 20



04

+BOOTH -GUN 1

081-19  
GUN 1

081-19  
GUN 1

083-19

03

01

LOCATION :

This document is propriety of SAMES and must not be reproduced or diffused without permission

01 02 03 04 05 06 07 08 09 10 11 12 13 14 15 16 17 18 19 20

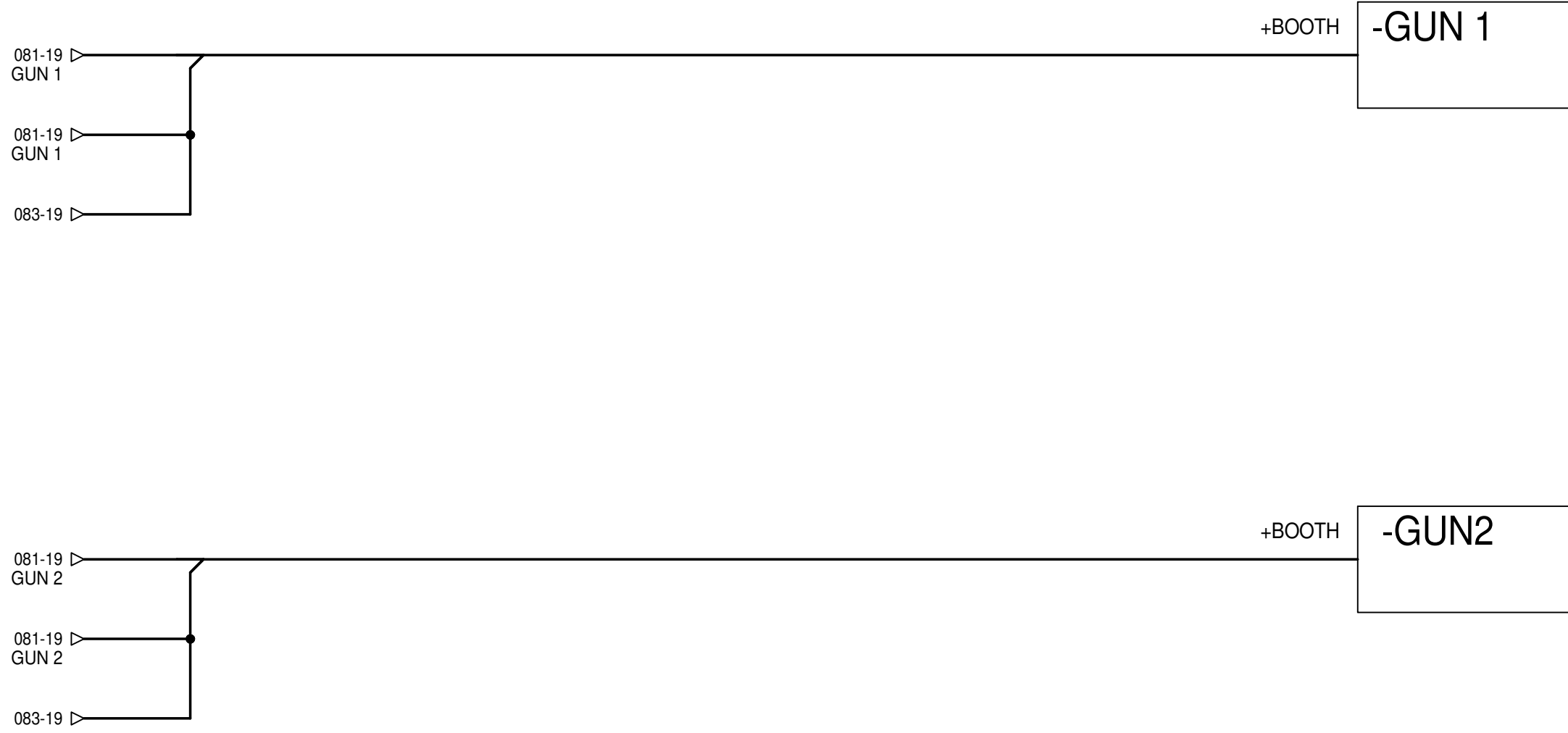

LOCATION :

This document is propriety of SAMES and must not be reproduced or diffused without permission

01 02 03 04 05 06 07 08 09 10 11 12 13 14 15 16 17 18 19 20

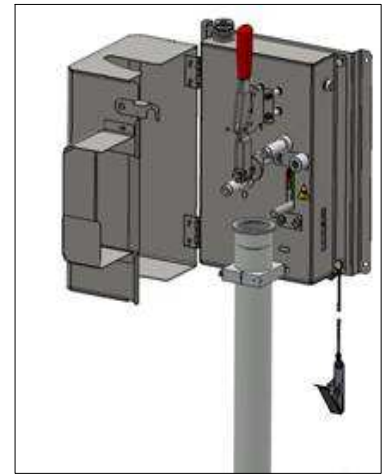

032-8 Flushing flushbox1 FBG\_1  
1303BLK1

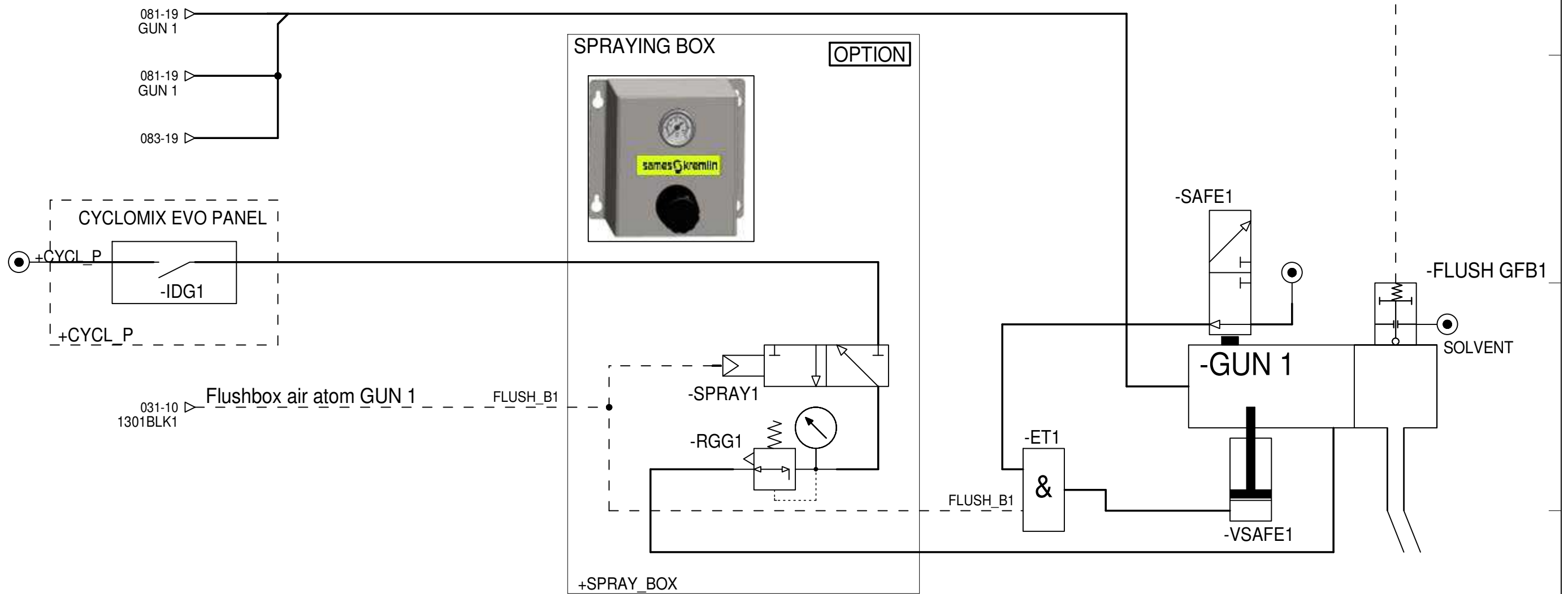

LOCATION :



This document is propriety of SAMES and must not be reproduced or diffused without permission

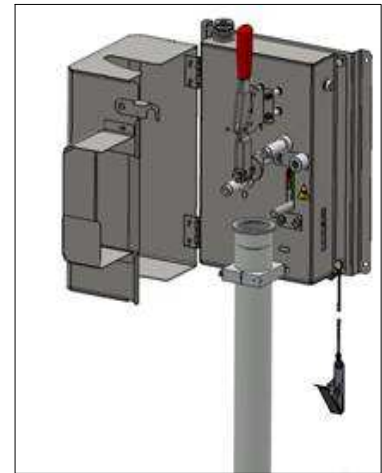

032-9 Flushing flushbox2 FBG\_2  
1303BLK1

081-19 GUN2  
081-19 GUN2  
083-19

SPRAYING BOX OPTION



CYCLOMIX EVO PANEL

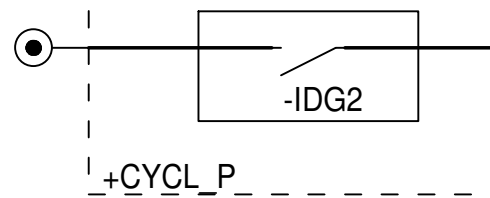

032-12 Flushbox air atom GUN 2 FLUSH\_B2  
1304BLK1

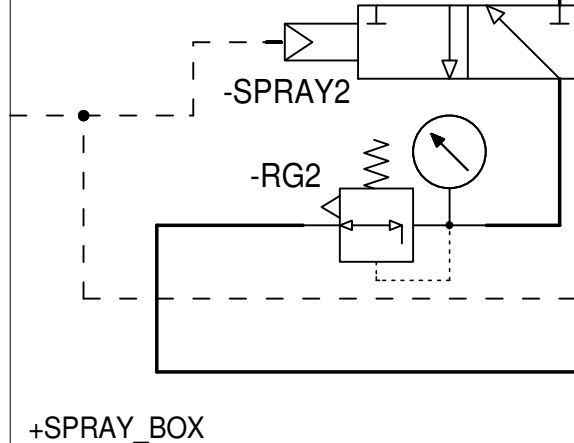

-SAFE2

-FLUSH GFB2

SOLVENT

-GUN 2

-ET2

-VSAFE2

FLUSH\_B2

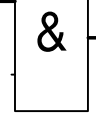

01

LOCATION :

This document is propriety of SAMES and must not be reproduced or diffused without permission

01 02 03 04 05 06 07 08 09 10 11 12 13 14 15 16 17 18 19 20

05

04

# VALVES BLOCKS

03

LOCATION OF  
MODULES ON  
THE BOX

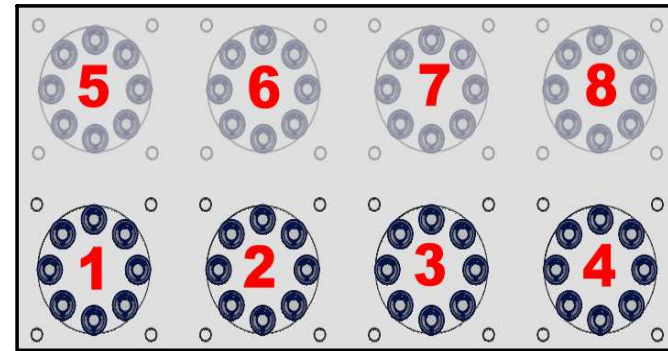

01

LOCATION :

This document is propriety of SAMES and must not be reproduced or diffused without permission

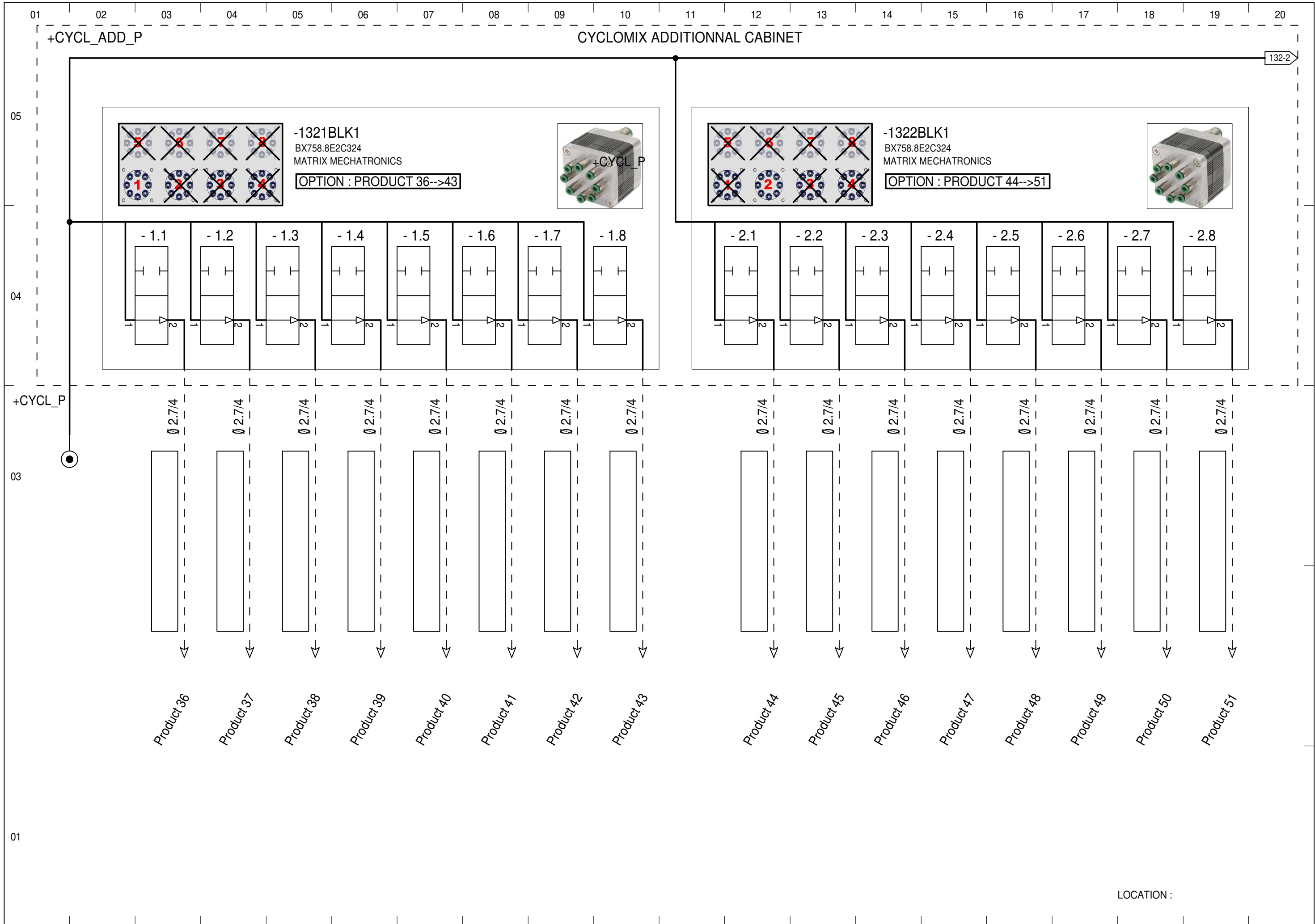

LOCATION :

This document is propriety of SAMES and must not be reproduced or diffused without permission

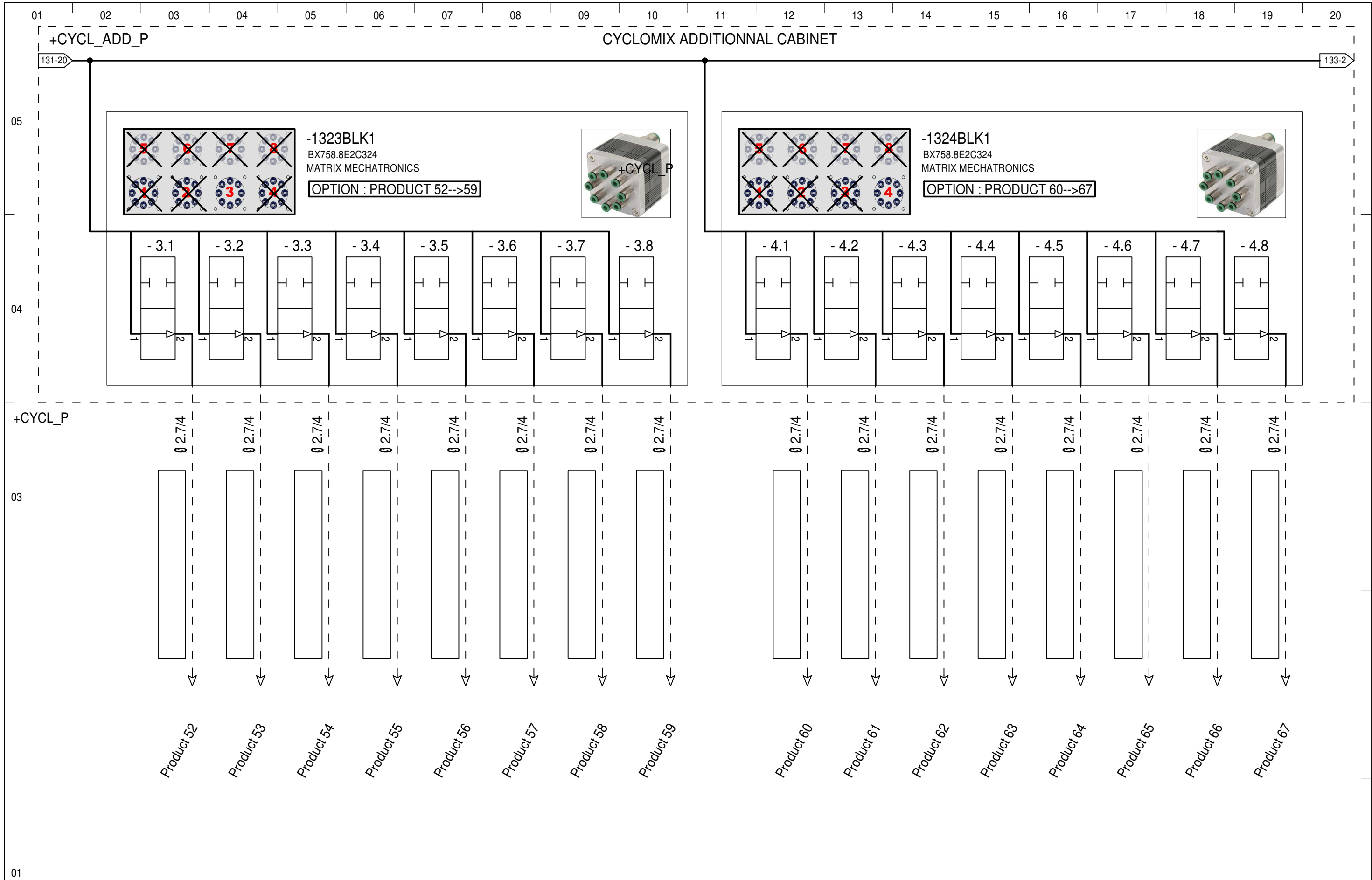

LOCATION :

This document is propriety of SAMES and must not be reproduced or diffused without permission

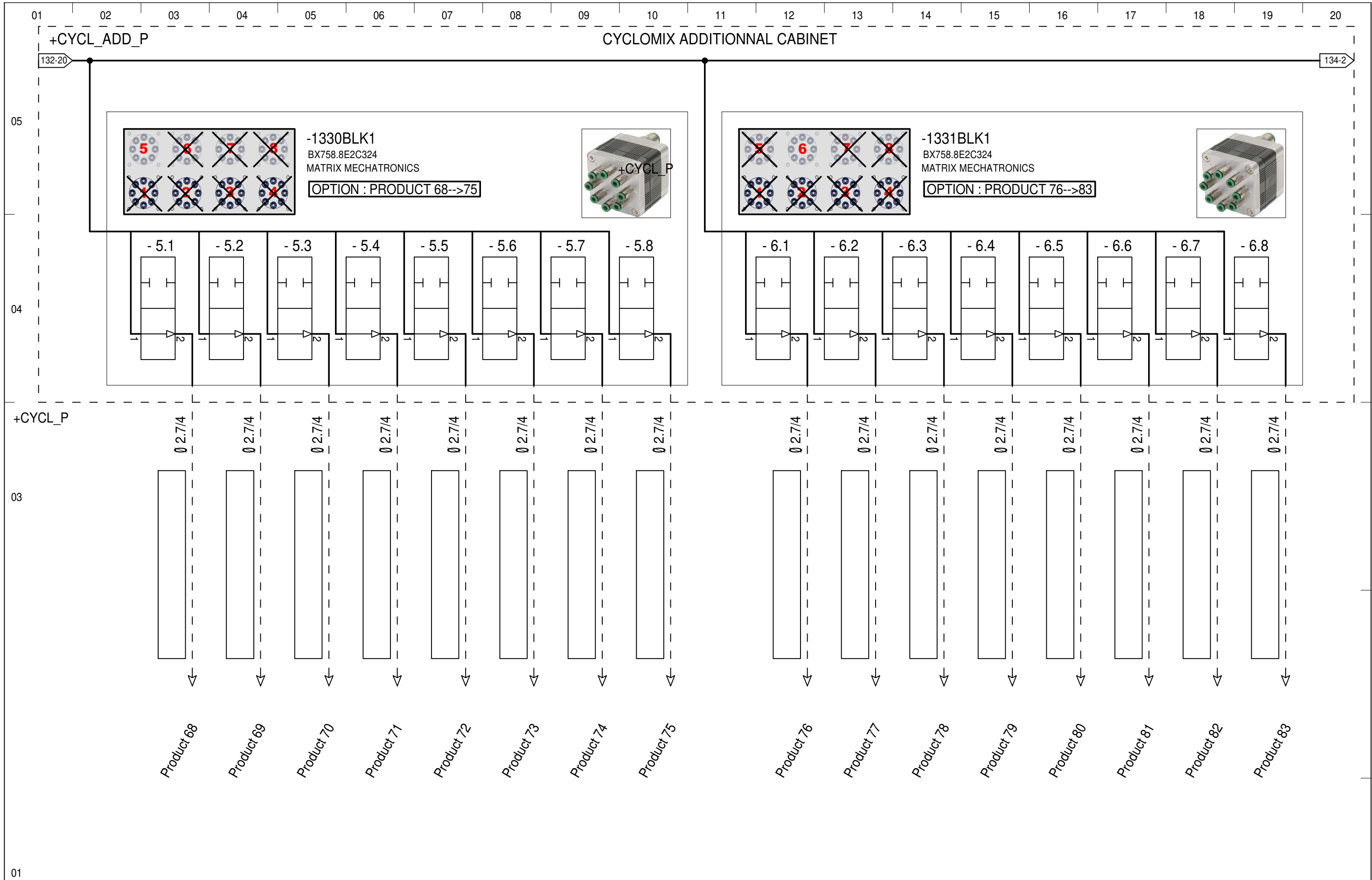

LOCATION :

This document is propriety of SAMES and must not be reproduced or diffused without permission

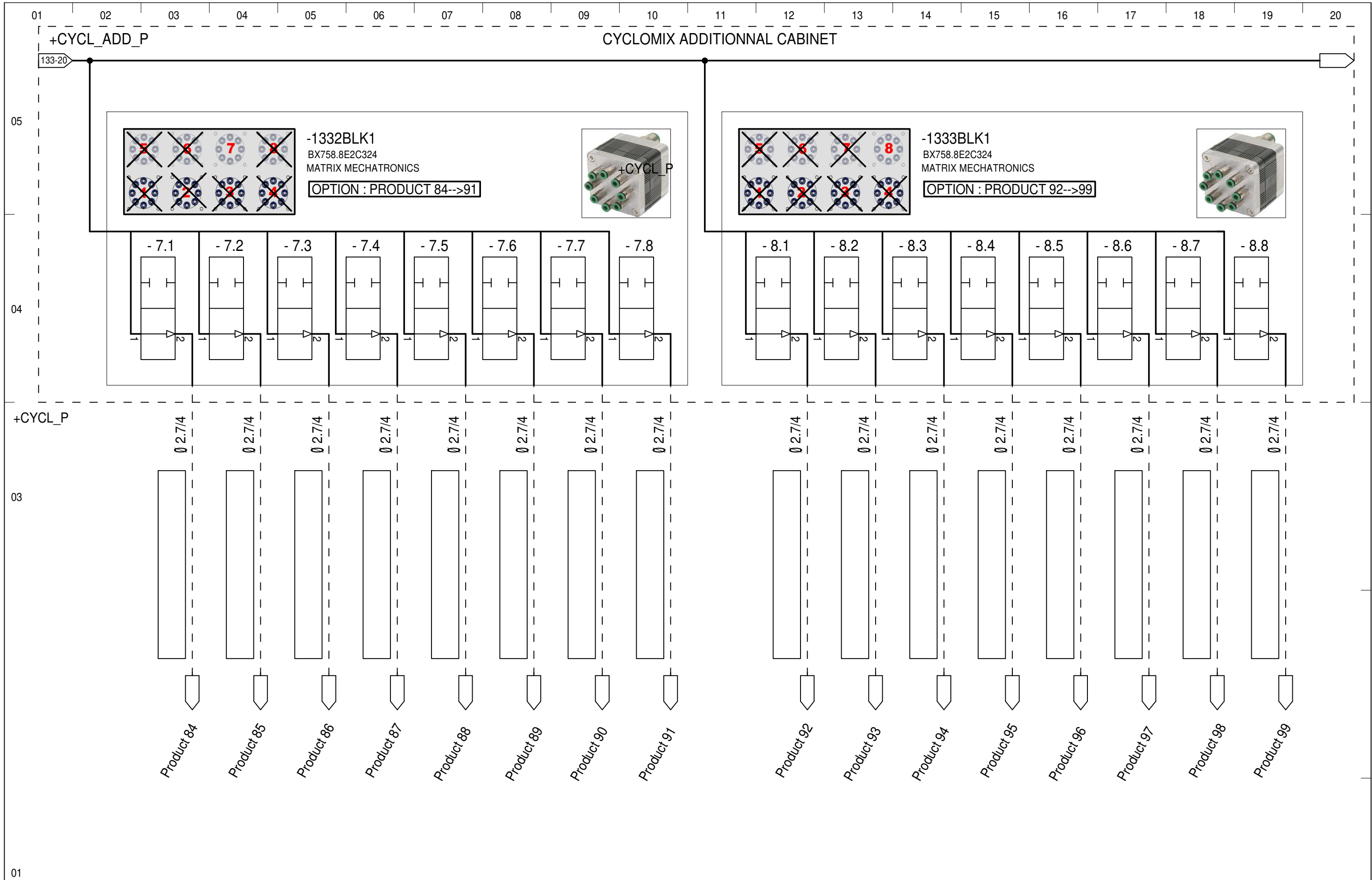

LOCATION :