

# Cyclomix<sup>®</sup> Evo

Instruction manual

**DRT582165110**

B - 2023/09

No part of this document may be communicated or reproduced in any form, nor may its contents be used or communicated, without the express written permission of **Sames**.

The descriptions and characteristics contained in this document are subject to change without notice.

© Sames 2023 - Translation of the original instruction manual

## Services



### Certification and referencing

**Sames** is certified as a training centre by the DIRRECTE of the Auvergne Rhône Alpes region under the number 84 38 06768 38.

Throughout the year, our company provides training courses that enable you to acquire the know-how required for the implementation and maintenance of your equipment in order to guarantee its long-term performance.

A catalogue is available on request.

[www.sames.com/usa/en/services-training.html](http://www.sames.com/usa/en/services-training.html)



### Line audit

As part of a technical assistance programme for our customers using **Sames** equipment, line audits are designed to help you optimise and control your production tool.

Our network of experts is continuously trained and qualified to provide our customers with technical expertise on the liquid or powder installations in which our equipment is integrated. The overall environment of the production lines is taken into account during this technical audit.

A brochure is available for download:

[www.sames.com/usa/en/services-service-contract.html](http://www.sames.com/usa/en/services-service-contract.html)



### Maintenance contract

An annual maintenance contract (including or not the consumables to be replaced during each intervention) can be considered with the partnership of **Sames**. It is associated with a preventive maintenance plan established during a first audit visit which details the control points necessary to guarantee the performance of the installed equipment.

[www.sames.com/usa/en/services-service-contract.html](http://www.sames.com/usa/en/services-service-contract.html)



### Hotline

[www.sames.com/usa/en/services-service-contract.html](http://www.sames.com/usa/en/services-service-contract.html)

## Cyclomix® Evo

1. Health and safety instructions -----	7
1.1. Configuration of the certified equipment .....	7
1.2. Marking .....	7
1.2.1. Marking of ATEX and non-ATEX boxes .....	7
1.2.2. Standards and guidelines applied .....	13
1.2.3. Glossary.....	14
1.3. Meaning of the pictograms .....	15
1.4. Precautions for use .....	16
1.4.1. Safety of persons .....	16
1.4.2. Integrity of the equipment .....	19
1.5. Warnings .....	19
1.5.1. Installation rules.....	20
1.6. Important recommendations .....	21
1.6.1. Limits of use and/or improper use .....	21
1.6.2. Safety recommendations during maintenance .....	22
1.6.3. Transport.....	22
1.6.4. Check the delivered items.....	23
1.6.5. Storage.....	23
1.7. Warranty .....	24
2. Description -----	25
2.1. Generalities .....	25
2.1.1. Property of the Cyclomix® Evo.....	25
2.1.2. How to use the Cyclomix® Evo.....	25
2.2. Function of the different components .....	26
2.2.1. Cyclomix® Evo presentation - 2K configuration.....	28
2.2.2. Cyclomix® Evo presentation - 3K configuration.....	28
2.2.3. Presentation of the main box.....	29
2.2.4. Présentation of the main box.....	29
2.2.5. Presentation of the additional box EVO+.....	30
2.2.6. Presentation of the additional box EVO+.....	30
2.2.7. Presentation of the remote box.....	31
2.3. Presentation of the remote box .....	31
2.3.1. Inside the box .....	31
2.3.2. Presentation of the electronic cards.....	32
2.4. Principle of designation and codification .....	43
2.4.1. ....Principle of significant designation of the Cyclomix® Evo	43
2.4.2. Commercial designation principle of the Cyclomix® Evo.....	49
2.5. Human/Machine Interface and operation .....	52
2.5.1. Cutting into 6 worlds.....	52
2.5.2. Configuring the Cyclomix® Evo - General settings.....	53
2.5.3. Calibrate a product .....	59
2.5.4. Manage recipes .....	61
2.5.5. Put in product .....	64
2.5.6. Priming .....	65
2.5.7. Production flushing.....	66
2.5.8. Machine flushing .....	69
2.5.9. Change a color.....	69



2.5.10. ....	Use the Batch function	70
2.5.11. Manage users. ....		71
2.5.12. Manage consumption. ....		74
2.5.13. Exploiting the Production screens. ....		75
2.5.14. Zoom function on ratio and flow rate. ....		77
2.5.15. Adjusting the ratio in production. ....		77
2.5.16. Register a batch number. ....		78
2.5.17. Paint optimization function. ....		78
2.6. Mobile application. ....		82
3. Technical features - - - - -		83
3.1. Technical features of the Cyclomix® Evo. ....		83
3.2. Dimensions (cm) . ....		84
3.2.1. Dimensions Cyclomix® Evo. ....		84
3.2.2. Main box dimensions. ....		85
3.2.3. Additional box Evo+ dimensions. ....		86
3.2.4. Remote box dimensions. ....		86
3.2.5. Cutout for the cabin assembly: Cyclomix® Evo remote box. ....		87
3.3. Operating principle. ....		88
3.3.1. File and communicate in network mode. ....		88
4. Schematics - - - - -		110
4.1. Fluid schematics. ....		110
4.2. Electrical schematic. ....		110
4.2.1. Main box. ....		110
4.2.2. Network overview. ....		111
4.3. Additional box EVO+ . ....		111
4.3.1. Implantation. ....		111
4.3.2. Network overview. ....		113
4.4. Remote box. ....		114
4.4.1. Implantation. ....		114
4.4.2. Network overview. ....		114
4.4.3. Installation of boxes. ....		115
5. Start-up - - - - -		116
5.1. Tools. ....		116
5.2. Installation. ....		117
5.2.1. Configuration of the product part in and out of the cabin. ....		117
5.2.2. Install the feet when unpacking the Cyclomix® Evo with frame. ....		118
5.2.3. Principle of slinging the Cyclomix® Evo. ....		120
5.2.4. Electrical connection. ....		121
5.2.5. Pneumatic connection. ....		121
5.2.6. Air supply to the box. ....		122
5.2.7. Location of cable outlets in the main box. ....		123
5.2.8. Location of the additional box cable outlets. ....		123
5.2.9. Equipotential bonding of the main box. ....		124
5.2.10. Equipotential bonding of the main box. ....		124
5.2.11. Equipotential bonding of the remote box. ....		125
5.2.12. Air supply to the product plate. ....		125
5.2.13. Air supply to the spray box. ....		126

5.2.14. Connection of the flowmeters .....	127
5.2.15. 2K gun overview complete option .....	131
5.2.16. 3K gun overview complete option .....	132
5.2.17. Connection of the mixing block .....	133
5.2.18. Injection valve connections .....	133
5.2.19. Test valves and AIRCHOP connections.....	134
5.2.20. Connection of the product valves.....	136
5.2.21. Connections of other functions .....	136
5.2.22. Connection of an electrostatic box.....	137
5.2.23. Leak tests .....	138
5.2.24. compatibility - hoses - product -pressure.....	140
5.3. Shutdown and start-up procedures .....	140
5.3.1. Installation stop .....	140
5.3.2. Switching off .....	140
5.3.3. Restart after power outage .....	140
5.4. Specific settings .....	140
6. Maintenance - - - - -	142
6.1. Maintenance summary table .....	143
6.1.1. Maintenance video .....	144
6.1.2. Additional maintenance .....	144
6.2. Preventive Maintenance Plan - PMP 582165110 .....	145
6.2.1. Pressure relief procedure.....	145
6.3. Servicing .....	146
6.4. Replacement .....	147
6.4.1. Starting up the EtherCAT bus .....	147
7. Troubleshooting - - - - -	152
8. History of revision indexes- - - - -	158
9. Appendixes - - - - -	159
9.1. Preventive Maintenance Plan .....	159
9.2. EU declaration of conformity and UKCA declaration .....	160

## **1. Health and safety instructions**

### **1.1. Configuration of the certified equipment**

This manual defines the configuration of the certified equipment.

### **1.2. Marking**

#### **1.2.1. Marking of ATEX and non-ATEX boxes**

Each device is marked with the name of the manufacturer, the reference of the device and the important information for the use of the device: air pressure, electrical power.

This equipment has been designed in accordance with ATEX Directive 2014/34/EU and is intended for use in use in area 1.

This equipment therefore complies with the following provisions:

- ATEX Directive (2014/34/EU): II 2 G - group II, category 2, gas).
- The EU Declaration of Conformity and the UKCA Declaration (specific to the UK market) are included in this document as annexes in this document as appendices.

## 1.2.1.1. Marking main box - ATEX nameplate

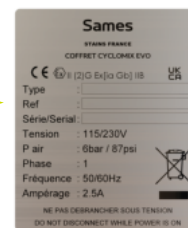

The main box is not an ATEX box. It is an associated box that can be connected to an ATEX board installed in an ATEX zone. There are therefore ATEX and non-ATEX versions.

Description	
<b>Sames Code</b>	Manufacturer's brand
<b>STAINS FRANCE</b>	Place of production of the equipment.
<b>Cyclomix®Evo box</b>	Product name
<b>CE</b>	CE: European Conformity
<b>Ex II (2) G</b>	<b>Ex</b> : Use in explosive areas II: Group II (2): Category 2 Surface equipment intended for use in environments where explosive atmospheres due to gases, vapors, mists are likely to occur occasionally during normal operation. G: Gas
<b>Ex</b>	Ex: Marking of conformity to European standards
<b>[ia Gb]</b>	ia: Intrinsic safety Gb: Equipment protection level (area 1 gas)
<b>IIB</b>	IIB: Reference gas for equipment qualification
<b>UKCA</b>	UKCA: UK Conformity Assessment Marking required for certain products placed on the market in Great Britain (England, Wales, Scotland) from January 2021
<b>Type</b>	Model of the box
<b>Ref</b>	Reference specific to the equipment manufacturer.
<b>Série/Serial</b>	Number given by <b>SAMES</b> Les 2 premiers chiffres indiquent l'année de fabrication
<b>Voltage</b>	Voltage of the Cyclomix®Evo
<b>P air</b>	Maximum air pressure
<b>Phase</b>	Single-phase
<b>Frequency</b>	50/60Hz > Mains frequency
<b>Ampérage</b>	Maximum current consumption
	This logo means that your used product must be disposed of in an appropriate recovery and recycling facility.
<b>NE PAS DÉBRANCHER SOUS TENSION DO NOT DISCONNECT WHILE POWER IS ON</b>	Failure to do so may result in death or serious injury.

1.2.1.2. Marking of main box - non ATEX nameplate

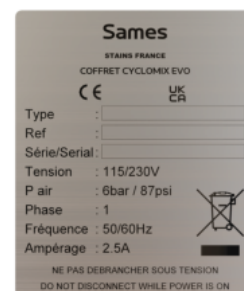

The main box is not an ATEX box. It is an associated box that can be connected to an ATEX board installed in an ATEX zone. There are therefore ATEX and non-ATEX versions.

Description	
<b>Sames Code</b>	Manufacturer's brand
<b>STAINS FRANCE</b>	Place of production of the equipment.
<b>Cyclomix®Evo box</b>	Product name
<b>CE</b>	CE: Conformité européenne
<b>UKCA</b>	UKCA: UK Conformity Assessment Marking required for certain products placed on the market in Great Britain (England, Wales, Scotland) from January 2021
<b>Type</b>	Model of the box
<b>Ref</b>	Reference specific to the equipment manufacturer.
<b>Série/Serial</b>	Number given by <b>SAMES</b> The first 2 digits indicate the year of manufacture
<b>Voltage</b>	Voltage of the Cyclomix®Evo
<b>P air</b>	Maximum air pressure
<b>Phase</b>	Single-phase
<b>Frequency</b>	50/60Hz > Mains frequency
<b>Amperage</b>	Maximum current consumption
	This logo means that your used product must be disposed of in an appropriate recovery and recycling facility.
<b>NE PAS DÉBRANCHER SOUS TENSION DO NOT DISCONNECT WHILE POWER IS ON</b>	Failure to follow this safety instruction could result in death or serious injury safety instructions.

1.2.1.3. Additional box Evo+ marking - ATEX nameplate

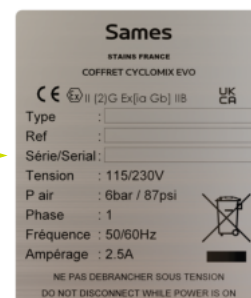

The additional box Evo+ is not an ATEX box. It is an associated box that can be connected to an ATEX board installed in an ATEX zone. There are therefore ATEX and non-ATEX versions.

Description	
<b>Sames Code</b>	Manufacturer's brand
<b>STAINS FRANCE</b>	Place of production of the equipment.
<b>Cyclomix®Evo box</b>	Product name
<b>CE</b>	CE: European conformity
<b>Ex II (2) G</b>	<b>Ex</b> : Use in explosive areas II: Group II (2): Category 2 Surface equipment intended for use in environments where explosive atmospheres due to gases, vapors, mists are likely to occur occasionally during normal operation. G: Gas
<b>Ex</b>	Ex: Marking of conformity to European standards
<b>[ia Gb]</b>	ia: Intrinsic safety Gb: Equipment protection level (zone 1 gas)
<b>IIB</b>	IIB: Reference gas for equipment qualification
<b>UKCA</b>	UKCA: UK Conformity Assessment Marking required for certain products placed on the market in Great Britain (England, Wales, Scotland) from January 2021
<b>Type</b>	Model of the box
<b>Ref</b>	Reference specific to the equipment manufacturer.
<b>Série/Serial</b>	Number given by <b>SAMES</b> The first 2 digits indicate the year of manufacture
<b>Voltage</b>	Voltage of the Cyclomix®Evo
<b>P air</b>	Maximum air pressure
<b>Phase</b>	Single-phase
<b>Frequency</b>	50/60Hz > Mains frequency
<b>Ampérage</b>	Maximum current consumption
	This logo means that your used product must be disposed of in an appropriate recovery and recycling facility.
<b>NE PAS DÉBRANCHER SOUS TENSION DO NOT DISCONNECT WHILE POWER IS ON</b>	Failure to follow this safety instruction could result in death or serious injury safety instructions.

1.2.1.4. Additional box Evo+ marking - non ATEX nameplate

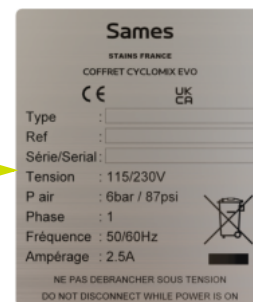

The additional box Evo+ is not an ATEX box. It is an associated box that can be connected to an ATEX board installed in an ATEX zone. There are therefore ATEX and non-ATEX versions.

Description	
<b>Sames Code</b>	Manufacturer's brand
<b>STAINS FRANCE</b>	Place of production of the equipment.
<b>Cyclomix® Evo box</b>	Product name.
<b>CE</b>	CE: European Conformity
<b>UKCA</b>	UKCA: UK Conformity Assessment Marking required for certain products placed on the market in Great Britain (England, Wales, Scotland) from January 2021
<b>Type</b>	Model of the box
<b>Ref</b>	Reference specific to the equipment manufacturer.
<b>Série/Serial</b>	Number given by <b>SAMES</b> The first 2 digits indicate the year of manufacture
<b>Voltage</b>	Voltage of the Cyclomix® Evo
<b>P air</b>	Maximum air pressure
<b>Phase</b>	Single-phase
<b>Frequency</b>	50/60Hz > Mains frequency
<b>Ampérage</b>	Maximum current consumption
	This logo means that your used product must be disposed of in an appropriate recovery and recycling facility.
<b>NE PAS DÉBRANCHER SOUS TENSION DO NOT DISCONNECT WHILE POWER IS ON</b>	Failure to follow this safety instruction could result in death or serious injury safety instructions

1.2.1.5. Marking remote box - non ATEX nameplate



Description	
<b>Sames Code</b>	Manufacturer's brand
<b>STAINS FRANCE</b>	Place of production of the equipment.
<b>Cyclomix® Evo box</b>	Product name
<b>CE</b>	CE: European conformity
<b>Ex II (2) G</b>	<p><b>Ex</b>: Use in explosive areas</p> <p>II: Group II</p> <p>(2): Category 2</p> <p>Surface equipment intended for use in environments where explosive atmospheres due to gases, vapors, mists are likely to occur occasionally during normal operation.</p> <p>G: Gas</p>
<b>Ex</b>	Ex: Marking of conformity to European standards
<b>[ia Gb]</b>	<p>ia: Intrinsic safety</p> <p>Gb: Equipment protection level (zone 1 gas)</p>
<b>IIB</b>	IIB: Reference gas for equipment qualification
<b>UKCA</b>	<p>UKCA: UK Conformity Assessment</p> <p>Marking required for certain products placed on the market in Great Britain (England, Wales, Scotland) from January 2021</p>
<b>Type</b>	Model of the box
<b>Ref</b>	Reference specific to the equipment manufacturer.
<b>Série/Serial</b>	<p>Number given by <b>SAMES</b></p> <p>The first 2 digits indicate the year of manufacture</p>
<b>Voltage</b>	Voltage of the Cyclomix® Evo
<b>P air</b>	Maximum air pressure
<b>Phase</b>	Single-phase
<b>Frequency</b>	50/60Hz > Mains frequency
<b>Ampérage</b>	Maximum current consumption
	This logo means that your used product must be disposed of in an appropriate recovery and recycling facility.
<b>NE PAS DÉBRANCHER SOUS TENSION DO NOT DISCONNECT WHILE POWER IS ON</b>	Failure to follow this safety instruction could result in death or serious injury safety instructions



## 1.2.2. Standards and guidelines applied

European Standards and Directives - EU	UK Standards and Guidelines - UKCA
<ul style="list-style-type: none"> <li>• 2006/42/CE Machinery</li> <li>• / Partly completed machinery.</li> <li>• 2014/34/UE Potentially Explosive Atmospheres.</li> <li>• EN ISO 80079-36: 2016</li> <li>• EN ISO 80079-37: 2016</li> <li>• EN 1127-1: 2019</li> <li>• 2014/35/UE Low voltage.</li> <li>• 2014/30/UE Electromagnetic Compatibility.</li> <li>• 2012/19/UE waste electrical and electronic equipment (WEEE).</li> </ul>	<ul style="list-style-type: none"> <li>• 2008 No. 1597 The Supply of Machinery (Safety) Regulations 2008</li> <li>• 2016 No. 1107 The Equipment and Protective Systems Intended for Use in Potentially Explosive Atmospheres Regulations 2016</li> <li>• EN ISO 80079-36: 2016</li> <li>• EN ISO 80079-37: 2016</li> <li>• EN 1127-1: 2019</li> <li>• 2016 No. 1091 The Electromagnetic Compatibility Regulations 2016</li> <li>• 2016 No. 1101 The Electrical Equipment (Safety) Regulations 2016</li> <li>• 2013 No. 3113 The Waste Electrical and Electronic Equipment Regulations 2013</li> </ul>

### 1.2.3. Glossary

#### **Base**

Component A

#### **Catalyst**

Component B, may also be referred to as hardener.

#### **Thinner**

Component C

#### **Product ratio**

For a product made of 2 components, a base (A) and a catalyst (B) are used.

The ratio R corresponds to the ratio B / A. If R = 10% it will be necessary that the mixture consists of 10 volumes of B for 100 volumes of A.

For a product made of 3 components, we use a base (A), a catalyst (B) and a diluent (C).

The ratio R1 corresponds to the ratio B / A. If R1 = 10%, the mixture must consist of 10 volumes of B for 100 volumes of A.

The ratio R2 corresponds to the ratio C / A. If R2 = 5%, the mixture must be made up of 5 volumes of C for 100 volumes of A.

#### **Alarm**

A malfunction detected by the Cyclomix<sup>®</sup> Evo but which does not stop it. An alarm is a preventive information given to the user that appears on the screen via a banner.

#### **Fault**

A malfunction detected by the Cyclomix<sup>®</sup> Evo stops the equipment concerned. Each fault is indicated on the screen. After each fault, the operator must reset the installation and acknowledge the fault..

#### **Gain**

Parameter defined in the recipe parameters. It is used to define the opening frequency of the injection valves for products B and C. The higher this value, the faster the opening frequency. This value can be between 1 and 3000. For information, a value of 125 corresponds to a valve opening of 0.8 seconds.

#### **Potlife**

Refers to the length of time that a multi-component product can be applied after mixing between the different components. .

The POTLIFE monitoring time (Lifetime) is a counter to measure the time of the product's non-circulation time.

#### **Priming**

Corresponds to the filling phase of the machine to have the product at the right ratio and well mixed before starting the production.

Concerns the current recipe and the volume of the priming remaining before going into production mode.

#### **Regeneration**

Phase of product renewal inside the circuits of the dosing system.

The operation is equivalent to the production phase, i.e. the dosing principle is continued.

1.3. Meaning of the pictograms

				
Electrical Hazard	Danger Automatic start	Danger Hot parts or hot surfaces	Danger Risk of explosion	General Danger
				
Danger High pressure	Danger Pinching and/or crushing	Danger Hazardous Location	Danger Risks of flammability	Danger Corrosive products
				
Danger Toxic materials	Danger Harmful products	Prohibition Wearing a Pacemaker	Obligation to wear protection auditory	Obligation to wear a visor of protection
				
Obligation protection of the respiratory tract	Obligation Port de chaussures de sécurité	Obligation Wearing of safety shoes	Obligation Wearing of gloves	Obligation Wearing a safety helmet
				
Obligation to wear safety glasses	General Obligation	Obligation Grounding	Obligation Consult the manual	

## 1.4. Precautions for use

### 1.4.1. Safety of persons

#### Technical manuals, labels



Before putting the equipment into operation, read carefully:

- All operating instructions,
- The labels on the equipment before putting the equipment into operation.

#### Training

Personnel using this equipment must be trained in its use.

#### Points of vigilance: instructions, safety.

The operators have assimilated perfectly:

- All instructions.
- All safety rules for this equipment and other elements and accessories of the installation.

#### Training and authorizations of operators

Personnel using this equipment must be trained in its use.

The shop manager must ensure that the operators have fully understood all the instructions and safety rules for this equipment and the other components and accessories of the installation.

Only authorized personnel will be allowed to perform production and maintenance operations on the equipment.

#### Personal Protective Equipment (PPE) - Workstation



The wearing of I.P.E. (Individual Protection Equipment) adapted to the risk situation is mandatory.

- Avoid abnormal postures.
- Maintain a stable position in order to keep your balance at all times, and thus better control the equipment in the event of an unexpected situation.
- Ensure that the workstation is neat and clean.
- Scattered or stacked parts and tools are sources of accidents.

### Qualification of the staff

Interventions on the Cyclomix<sup>®</sup> Evo must only be carried out in accordance with the rules and regulations in force, by trained and qualified personnel.

The following conditions must be met:

- The personnel must have special skills and experience in the relevant technical field. This applies in particular to maintenance and repair work on the Cyclomix<sup>®</sup> Evo devices.
- The personnel must be familiar with the applicable standards, guidelines, accident prevention regulations and operating conditions.
- The personnel must have been authorized by the safety officer to perform the required tasks.
- Personnel must be able to recognize and avoid potential hazards.
- The required qualifications of the personnel are subject to different legal regulations depending on the site of implementation. The owner must ensure compliance with applicable laws.
- Qualified personnel must be familiar with the product safety data sheets that they will be required to use in the operation of the Cyclomix<sup>®</sup> Evo.

### Operation of the equipment



The manufacturer cannot be held responsible in case:

- Personal injuries.
- Of breakdowns.
- Damage to equipment resulting from destruction.
- Total or partial concealment or removal of the protection.

### Imperative recommendations

- Do not modify or alter the equipment.
- Parts and accessories must be exclusively supplied or approved by **Sames**.

### Exploitation of the implemented products

Given the diversity of products used by users and the impossibility of listing all the characteristics of chemical substances, their interactions and their evolution over time, Sames cannot be held responsible:

- The poor compatibility of the materials in contact,
- Inherent risks to personnel and the environment,
- Wear and tear, maladjustments, malfunctions of equipment or installations as well as the qualities of the finished product.

**Sames** declines all responsibility in case of:

- Physical or psychological injuries.
- Direct or indirect material damage due to the use of chemical substances.
- Recommendations and responsibilities of the operator of the Cyclomix® Evo on the use of the applied products.
- The user must identify and prevent potential hazards inherent in the products used, such as toxic vapors, fires or explosions.
- The user will determine the risk of immediate or repeated exposure reactions on personnel

**Product used**

- The diversity of the products used by the users,,
- The impossibility of identifying all the characteristics of chemical substances,
- Their interactions and their evolution over time,

**Sames** will not be held responsible:

- The poor compatibility of the materials in contact.
- Inherent risks to personnel and the environment.
- Wear and tear, maladjustments, malfunctions of equipment or installations as well as the qualities of the finished product.

Therefore :

- The user must identify and prevent potential dangers inherent to the products used, such as toxic vapors, fires or explosions..
- The user should determine the risk of immediate or repeated exposure reactions on personnel.

**Sames** declines all responsibility, in case of:

- physical or psychological injuries,
- direct or indirect material damage due to the use of chemical substances.

**Operational control requirements of the equipment operator**

Personnel using this equipment must be trained in its use.

The operators have perfectly assimilated all the instructions and safety rules of this equipment and of the other elements and accessories of the installation.

#### 1.4.2. Integrity of the equipment



- Engine cover.
- Coupling protector.
- Carters.

#### Protection device

Protectors allow safe use of the equipment.

#### 1.5. Warnings



It is imperative that anyone with a pacemaker not use the equipment or enter the projection area.  
The high voltage may cause the pacemaker to malfunction.



This equipment may be dangerous if not used, disassembled and reassembled in accordance with the rules specified in this manual and any applicable European Standard or national safety regulations.



The correct operation of the equipment is guaranteed only with the use of original spare parts distributed by Sames.



In order to ensure optimum assembly, spare parts should be stored at a temperature close to their operating temperature. If not, a sufficient waiting time must be observed before installation, so that all parts are assembled at the same temperature.

### 1.5.1. Installation rules



**The installation of any system that does not comply with the rules specified below is strictly prohibited.**

#### Environment



Environmental risks must be controlled in the following manner:

- Have a qualified electrician check for ground continuity. If ground continuity is not assured, check the terminal, wire and grounding point. Never operate the equipment until this problem is resolved.
- The materials to be painted must also be grounded by means of clamps equipped with cables or, if they are suspended, by means of hooks that must remain clean at all times.
- Respect the average temperature of use of equipment and products, which must be at least 5°C lower than the flash point of the products and within a range of 0 to 40°C.
- Ventilation of the area by forced extraction and supply of unpolluted air shall be mandatory during equipment use or cleaning operations.
- Fragile parts of the installation, especially the hoses, must be protected from mechanical or thermal damage during production or maintenance.
- The waste related to the operations or the dismantling of the equipment will have to be treated according to the laws in force.
- The noise level of our equipment is limited to the maximum.
- Depending on the operating conditions, the sound pressure of the equipment may cause hearing damage.
- Take appropriate measures to reduce noise pollution.
- Dispose of packaging materials in a proper and environmentally friendly manner.



#### **CAUTION Danger to personnel from improper installation.**

- The exact delimitation of the zones is the express responsibility of the user, depending on the products used, the environment of the equipment and the conditions of use.
- Select the pump so that the fluid pressure delivered by the pump is appropriate for the type of gun selected.
- Using a high pressure hose, connect the paint fitting on the gun to the pump. Tighten the fittings.
- The pressure resistance of the hose must be equal to or greater than the pressure delivered by the pump.



## 1.6. Important recommendations

### 1.6.1. Limits of use and/or improper use

Any use other than that described in this document and the operating instructions, as well as any use beyond that, is considered improper. The manufacturer accepts no liability for any resulting damage. The user bears the sole risk.

The following points describe incorrect or prohibited use:

- Since the operating pressures of this equipment are particularly high, certain precautions should be taken to avoid accidents.  
Never exceed the maximum working pressure of the equipment components

#### Hoses

- Do not use hoses with a burst pressure limit (BPL) less than 4 times the maximum working pressure of the pump (see data sheet).
- Do not use hoses that have been bent and uncoiled. Use only hoses that are in good condition and free of injuries and wear.
- Use only anti-static grade air hose to connect the pump to the gun.
- All connections must be tight and in good condition.

#### Pump

- Connect the equipment to a grounded outlet.
- Use the connection provided on the pump.
- Do not use any product or solvent that is not compatible with the pump materials.
- Use the appropriate solvent for the product to be sprayed to ensure the longevity of the equipment.

#### Gun

- Never wipe the tip of the nozzle with your fingers.
- Any intervention on the gun must be done after the product has been decompressed.
- Do not point the sprayer at people or animals.

#### Cyclomix<sup>®</sup>Evo

- Do not install the machine's control panel in an explosive area.
- Connect the control box to an earthed mains socket.
- The product box is equipped with a ground cable.
- Connect the ground cable to a ground connection.
- Do not use any product or solvent that is not compatible with the materials of the machine.
- Use the appropriate solvent for the product to be sprayed to ensure longevity of the equipment.
- Wear safety glasses to protect your eyes from possible splashes when handling the Cyclomix<sup>®</sup>Evo test valves.
- Do not use electrostatic spraying for water-soluble paints, paints with a resistivity below 10 M $\Omega$ .

## Equipment generalities

It is prohibited to:

- Carrying products that do not meet specifications.
- Use, maintenance, repair, installation or commissioning of the Cyclomix<sup>®</sup> Evo by unauthorized, untrained personnel or by a private user.
- Use the Cyclomix<sup>®</sup> Evo without grounding.
- Use the Cyclomix<sup>®</sup> Evo outside the indicated parameters / operating data.
- Use the Cyclomix<sup>®</sup> Evo in an area where there is a risk of ignition due to ignition sources present in the vicinity of the equipment
- Non-compliance with maintenance intervals.
- Use the Cyclomix<sup>®</sup> Evo in zones where there is a risk of gas or dust explosion in zone 0 or use it in zones where there is a risk of explosion without prior implementation by the operator of measures in accordance with the requirements of directive 1999/92/EC and the national regulations in force for protection against explosions
- First start-up without prior control of the area and the Cyclomix<sup>®</sup> Evo by an authorized person.
- Use of products that are chemically incompatible with the materials used in the construction of the Cyclomix<sup>®</sup> Evo: The operator of the Cyclomix<sup>®</sup> Evo must control the chemical compatibility of the products used.
- Use of products whose characteristics (e.g. ignition temperature) are not compatible with the identification of the Cyclomix<sup>®</sup> Evo.
- Bypassing the safety features of the Cyclomix<sup>®</sup> Evo.

### 1.6.2. Safety recommendations during maintenance

#### Daily actions

- Check the equipment.
- Maintain the equipment in perfect working order.

Before cleaning or dismantling any component of the equipment, it is imperative to:

- Replace damaged parts only with original **Sames** parts.
- Turn off the supply air.
- Relieve pressure on hoses by opening the gun's fluid circuit.
- Switch off the power supply to the machine.
- Open the bleed valves.

### 1.6.3. Transport

Put the product in its original packaging during transport.

The packaging of the Cyclomix<sup>®</sup> Evo corresponds to the transport conditions provided for this purpose.

The packaging protects:

- Damage related to transportation.
- Of corrosion.

#### 1.6.4. Check the delivered items

- Remove the Cyclomix<sup>®</sup> Evo from its packaging.
- Dispose of packaging properly. Comply with your local regulations..
- Check that the Cyclomix<sup>®</sup> Evo has not been damaged during transport.
- Immediately notify the carrier and Sames in writing of transportation damage.
- Protect the Cyclomix<sup>®</sup> Evo from further damage.
- Use the packing slip to verify the completeness of the delivery..

#### 1.6.5. Storage

Our equipment must be stored in its original packaging.

In the event of prolonged storage, it is advisable to carry out preventive maintenance on all lubricants before commissioning.

Storage before installation

Ambient storage temperature 0 / +50 °C.

- Protect the unit from dust, water runoff, moisture, vibration and shock.
- Do not remove the packaging until just before assembly.

Storage after installation

- Protect the unit from dust, water runoff, moisture and impact.

## 1.7. Warranty

**Sames** provides a contractual warranty for a period of twelve (12) months from the date of delivery to the customer, provided that the conditions of use indicated in this technical manual are respected.

In order to be implemented, the warranty request must precisely define in writing the malfunction in question, must be accompanied by the defective material and/or component and must be informed of the conditions of the equipment purchased by the customer from **Sames**.

**Sames** will only accept or reject the implementation of the warranty after analysis of the defective material.

The warranty granted by **Sames** is limited to the replacement of the material in its entirety or the partial replacement of the defective component.

**Sames** will only cover the cost of the parts needed to replace the defective equipment.

No warranty will be given by **Sames**:

- For defects and deterioration resulting from abnormal storage and/or conservation conditions at the client's premises or for maintenance or use of the Equipment that does not comply with the rules of the trade or that does not respect the prescriptions of this technical manual given to the client by **Sames**,
- For defects and damage resulting from Non-OEM replacement parts or parts which have been modified by customer,
- For all damages resulting from negligence or lack of supervision.

From the customer:

- In case of normal wear and tear of the Equipment and/or its components.
- In case of deterioration or accident due to defective and/or abnormal use of the product.

## 2. Description

### 2.1. Generalities

#### 2.1.1. Property of the Cyclomix<sup>®</sup> Evo

The Cyclomix<sup>®</sup> Evo designed to:

- Mixing and dosing up to 3 products,
- Supply of 1 or 2 guns by managing independently the Potlife (product life time), the priming of color and the flushing of each circuit.

Color changers located upstream of the flow meters allow the mixing block to be supplied with different colors or catalysts.

The color change is entirely managed by the Cyclomix<sup>®</sup> Evo. The color change is defined in the recipe parameters.

The flowmeters control:

- Reading the flows.
- The passage of products.

The Cyclomix<sup>®</sup> Evo is configurable, modular and scalable.

The Cyclomix<sup>®</sup> Evo can integrate from the installation or during its life cycle equipment such as:

- Product regulators.
- Flushing boxes for manual gun.
- Management of a 3<sup>rd</sup> component.
- Waste sorting management.

#### 2.1.2. How to use the Cyclomix<sup>®</sup> Evo

The Cyclomix<sup>®</sup> Evo has been developed to be easy to use. For this reason, it is possible to configure it according to 2 modes. The Cyclomix<sup>®</sup> Evo allows:

- To work using the parameters defined by the dosing unit itself.
- Or to work with the parameters defined by the user.





The main functions that can be set automatically by the dosing unit are:



- Flushing.
- Frequency of injection.

When the dosing unit is delivered, the automatic mode is selected by default.

The user can uncheck the automatic box. This will open a number of screens allowing him to define the value(s) he wants.

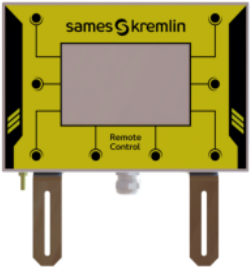
## 2.2. Function of the different components

Component	Function
<p>Cyclomix® Evo 2K</p> 	<p>A 2K dosing system is a system that mixes two liquid components (usually bases and hardeners) in a precise ratio to form a solid film. 2K dosing systems can be manual or automatic. 2K dosing systems are often used for applications that require high precision in dosing and mixing of components to ensure the quality of the final product.</p>
<p>Cyclomix® Evo 3K</p> 	<p>A 3K dosing system is similar to a 2K dosing system, but it mixes three liquid components (usually films, hardeners and thinner) in a precise ratio to form a solid material. This type of system is used in applications that require greater formulation flexibility, such as applications that require specific end-material properties or for properties of the final materials or for applications that require more complex mixtures. The addition of the 3<sup>rd</sup> component allows the required viscosity to be adjusted according to the application technology</p>
<p>Cyclomix® Evo main box</p> 	<p>The function of a control box for a 2K or 3K dosing system is to control the 2K or 3K product stage to provide the essential functions for dosing and mixing the various components. It can also include control mechanisms to adjust the dosing ratio and indicators to display dosing data.</p>
<p>Cyclomix® MicroEvo box</p> 	<p>The basic cabinet components are designed to:</p> <ul style="list-style-type: none"> <li>• Control and monitor the system.</li> <li>• Display production data (e.g. ratio, flow rate or Potlife).</li> </ul>
<p>Remote Control (R.C.) Box</p> 	<p>The remote cabinet for a 2K or 3K dosing system is an enclosure to perform production operations such as color changes or flushing cycles. The remote box can be used for safety, convenience or for applications where space is limited. The remote box is connected to the main box by a network cable allowing communication between the communication between the 2 cabinets.</p>

Component	Function
<p data-bbox="225 275 371 300">Air regulation</p> 	<p data-bbox="504 333 1437 394">An air control box is used to regulate and control the spray air pressure of the gun. air pressure of the spray gun.</p> <p data-bbox="504 398 1437 423">The box also allows the spray air to be cut off during the priming and flushing phases.</p>
<p data-bbox="124 499 276 524">Flushbox gun</p> 	<p data-bbox="504 589 1023 613">The gun flushing box has the following function</p> <ul data-bbox="544 618 1437 678" style="list-style-type: none"> <li data-bbox="544 618 1437 642">• substitute the operator during the priming, regeneration or gun flushing phases used with the 2K and 3K dosing systems.</li> </ul>

2.2.1. Cyclomix® Evo presentation - 2K configuration

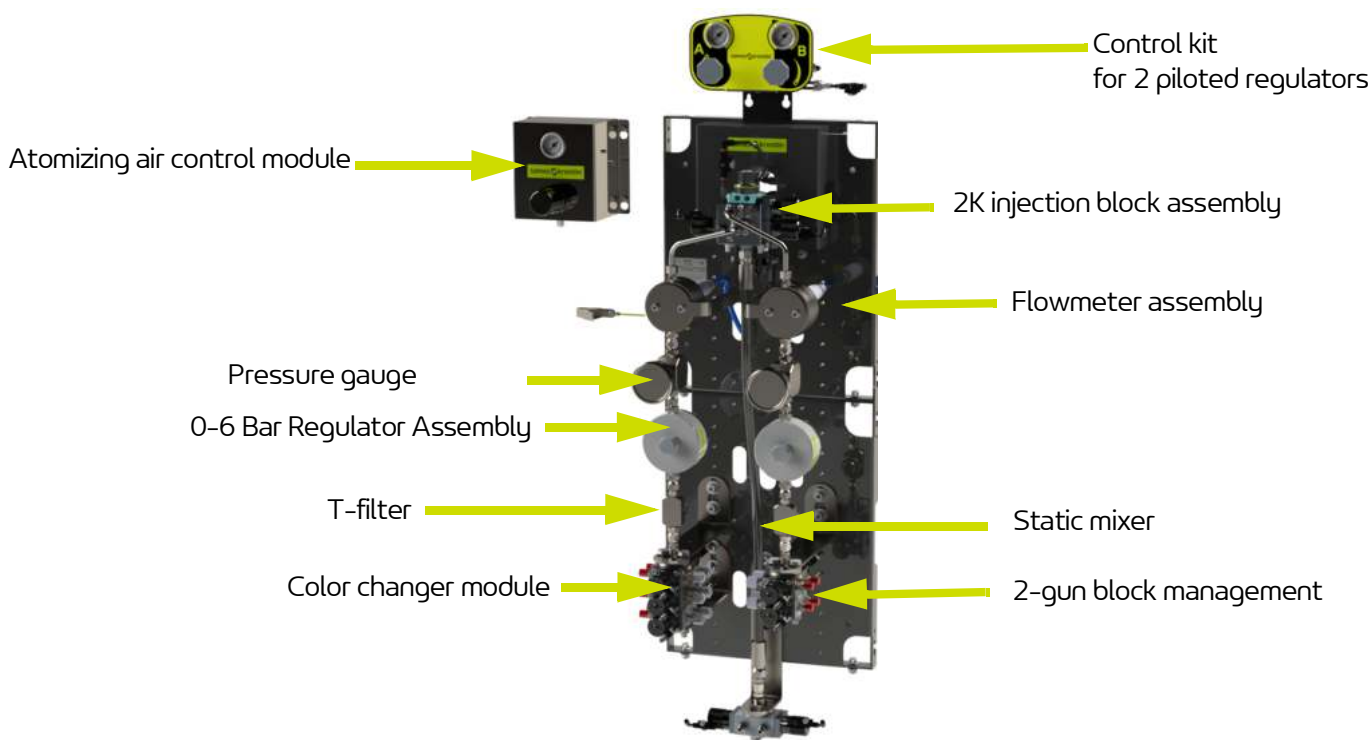

2.2.2. Cyclomix® Evo presentation - 3K configuration

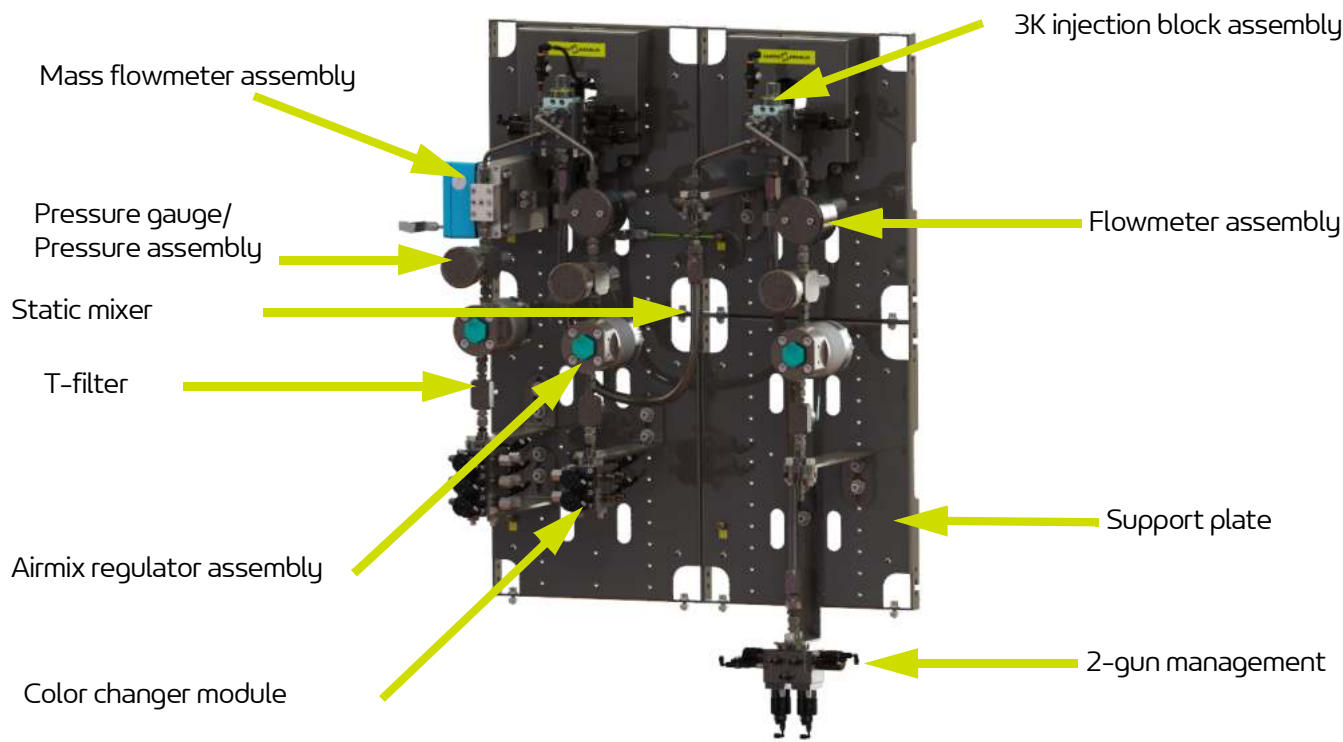



2.2.3. Presentation of the main box

2.2.3.1. Exterior of the box

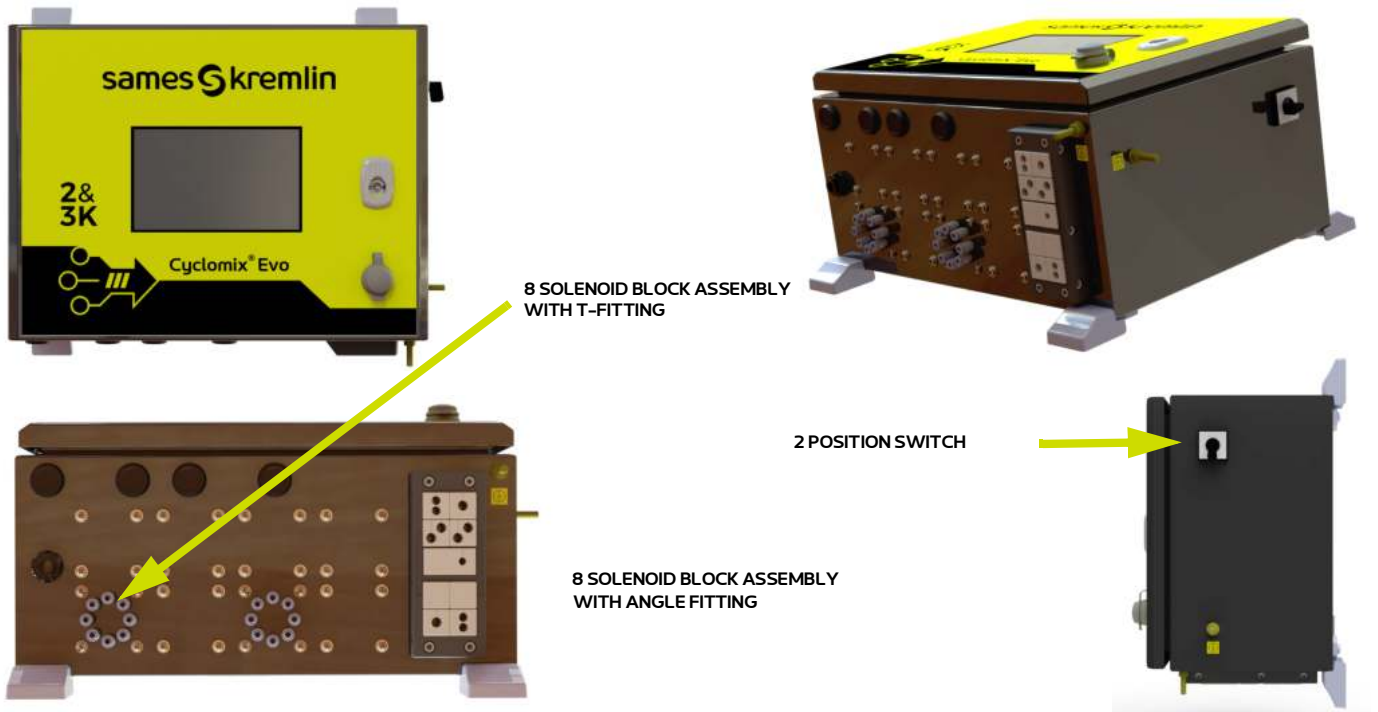

2.2.4. Présentation of the main box

2.2.4.1. Inside the box

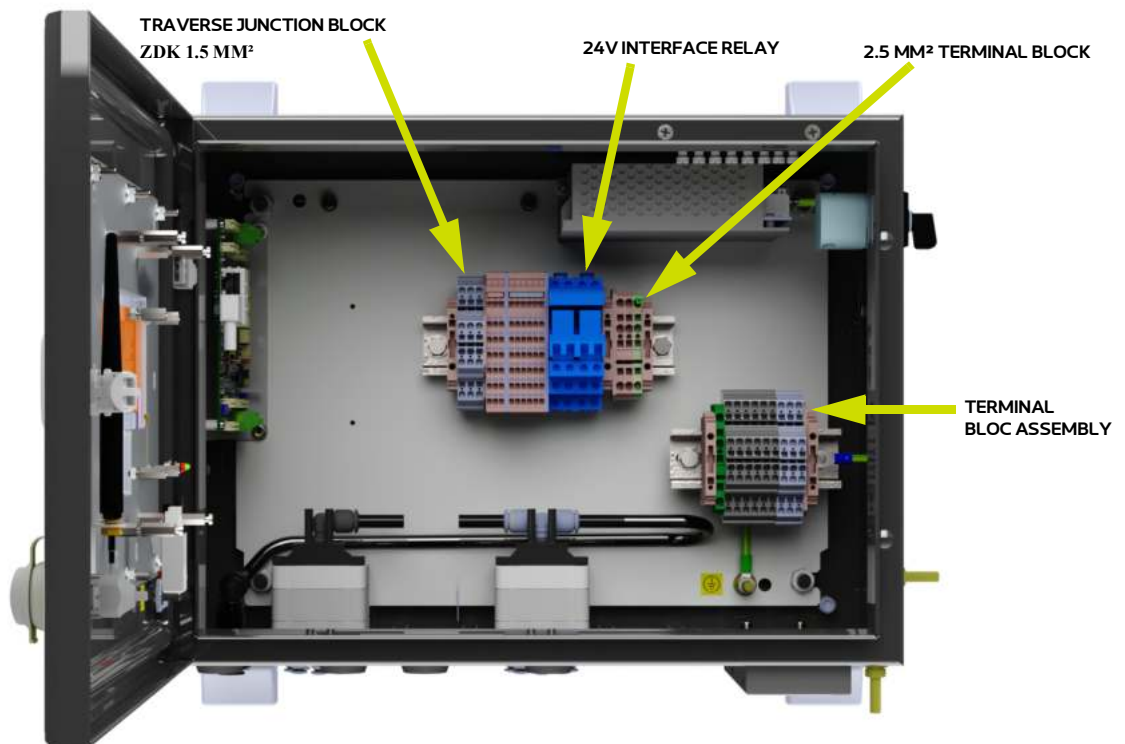

2.2.5. Presentation of the additional box EVO+

2.2.5.1. Exterior of the box



2.2.6. Presentation of the additional box EVO+

2.2.6.1. Inside the box

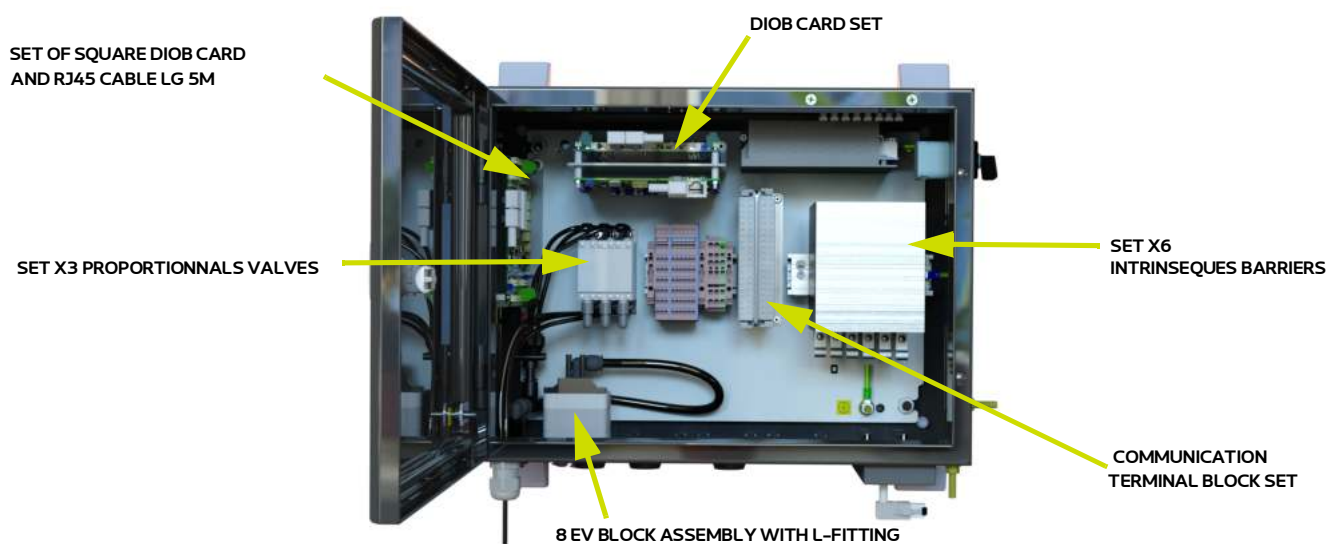

## 2.2.7. Presentation of the remote box

### 2.2.7.1. Exterior of the box

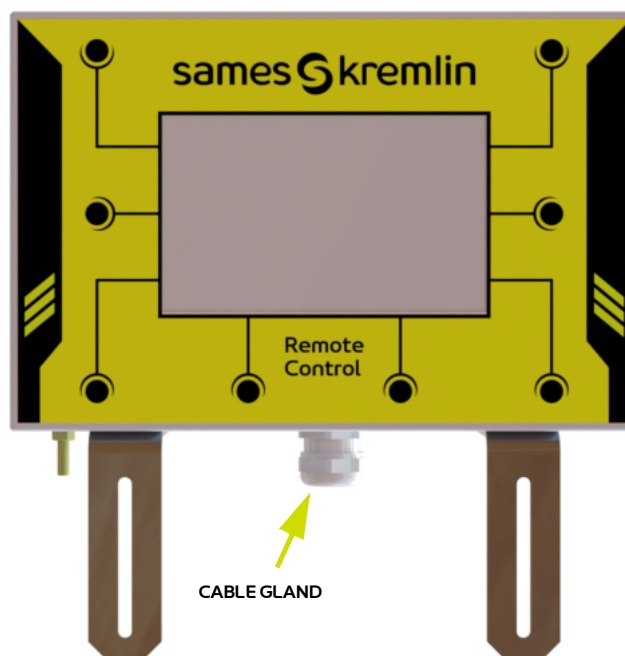

## 2.3. Presentation of the remote box

### 2.3.1. Inside the box

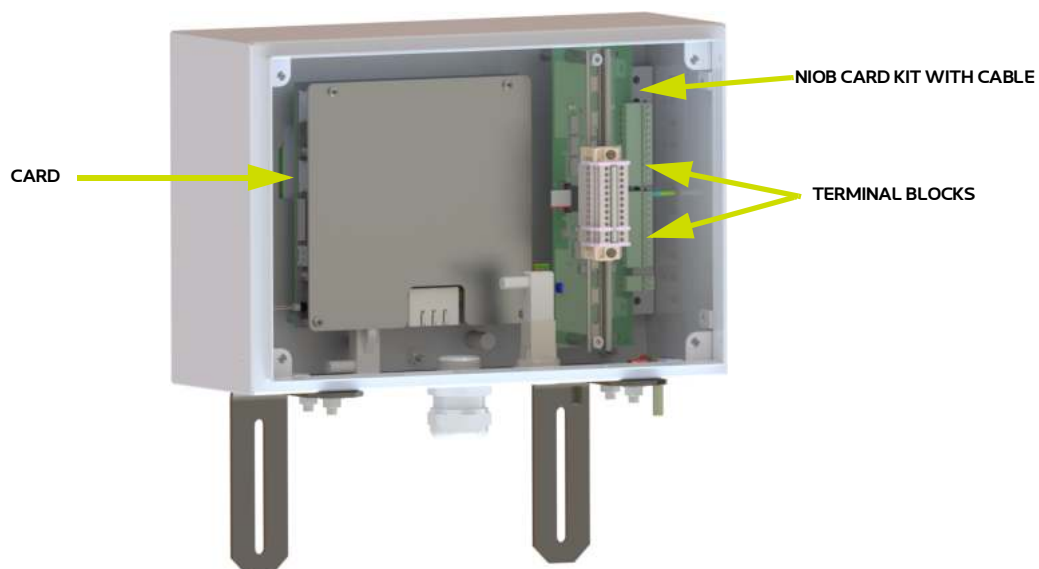

### 2.3.2. Presentation of the electronic cards

#### 2.3.2.1. Presentation of the CCB card

The CCB (Common Control Board) is the motherboard. The CCB board manages the machine process and collects information from the daughter boards.

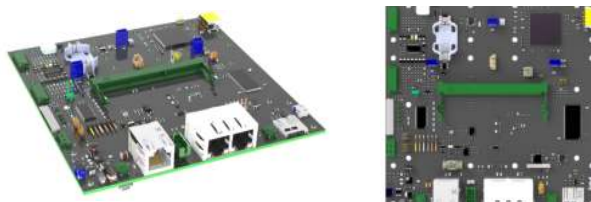

#### LED description

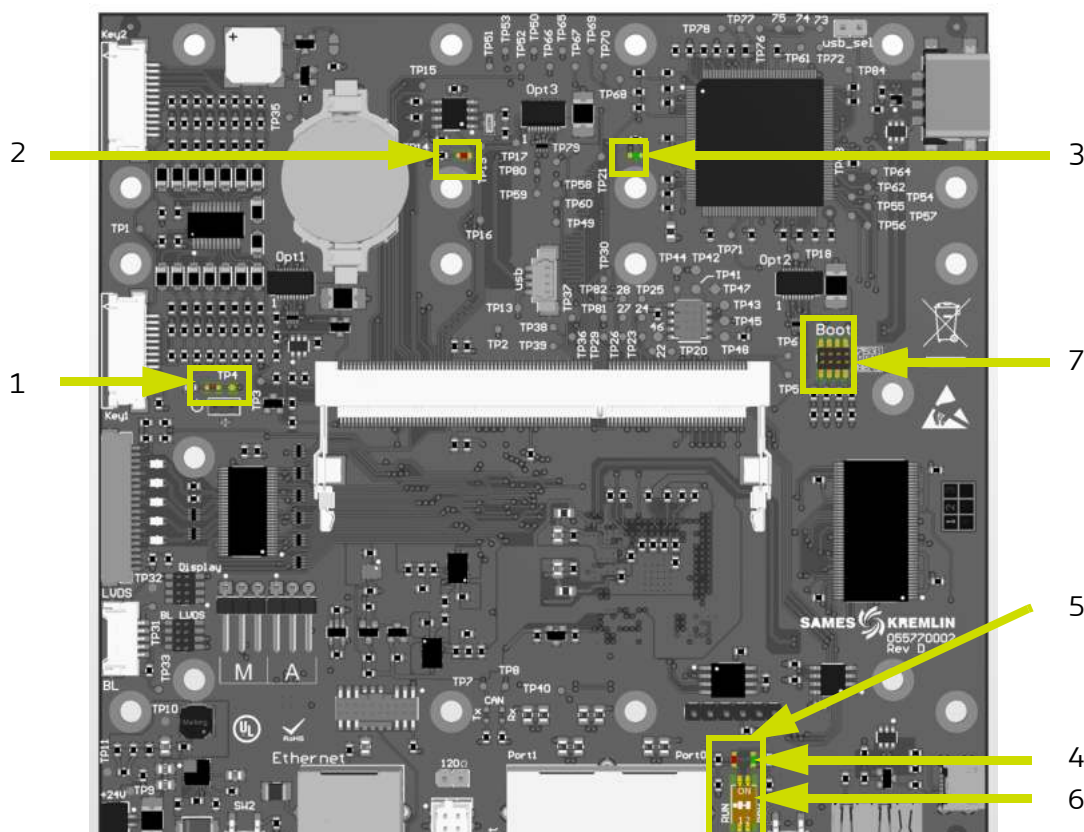

#	LED status	Description
1	red LED	When ON it signals that the main chip is running. <ul style="list-style-type: none"> <li>If it is not ON check that the boot jumper are in place (See7).</li> </ul>
2	red LED	When ON it signals that the board is powered. <ul style="list-style-type: none"> <li>If it is not ON check that the board is powered.</li> </ul>
3	green LED	When ON, it means that the bridge is on.
3	green LED (blinking)	When the LED flashes, this indicates an error on the bridge. The user should try to restart the bus in the maintenance menu or restart the machine completely.
4	green LED	LED RDY - The EtherCAT chip is running. <ul style="list-style-type: none"> <li>User should check that both switches (See 6) are set to OFF and reboot the cabinet.</li> </ul>

#	LED status	Description
5	orange LED	LED RUN - When ON or blinking it indicates the EtherCAT chip is not running <ul style="list-style-type: none"> <li>User should check that both switches (cf. 6) are set to OFF and reboot the cabinet.</li> </ul>

**Position of the connectors**

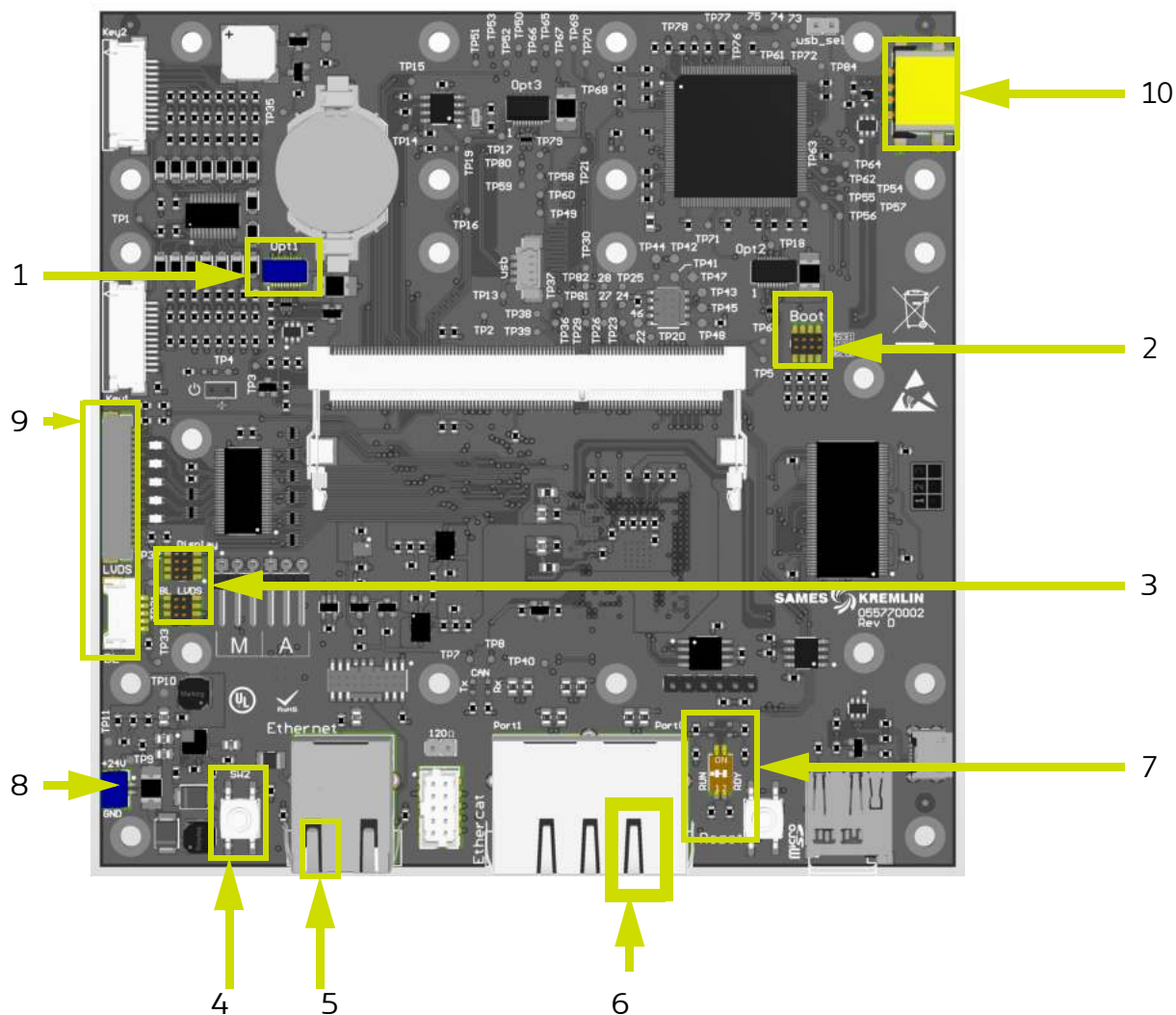

#	Description
1	Connector to robot board
2	Boot jumpers
3	7' screen jumpers
4	Ethernet connector to deported screen
5	NIOB connector
6	Ethernet connector to daughter boards (on Port 0, on the right).
7	EtherCAT switches
8	Power connector (24V)
9	Screen cables connector
10	USB connector, used for machine software update and data exportation



Screen jumpers visualization

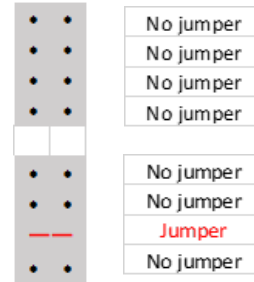
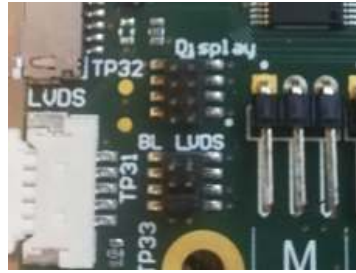

Position of the display cables and Ethernet cables

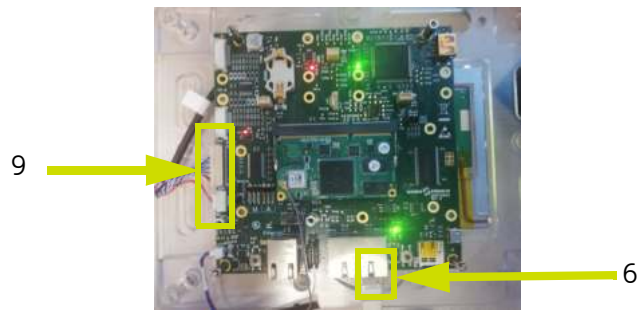

Boot jumpers



### 2.3.2.2. Presentation of the ANAB card

The ANAB (Analog Board) is a daughter board, it allows the control of analog device (proportional valve...) and the reading of analog value (temperature sensor, pressure sensor...).

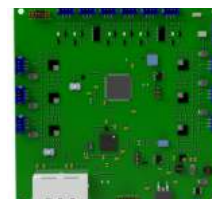

#### LED description

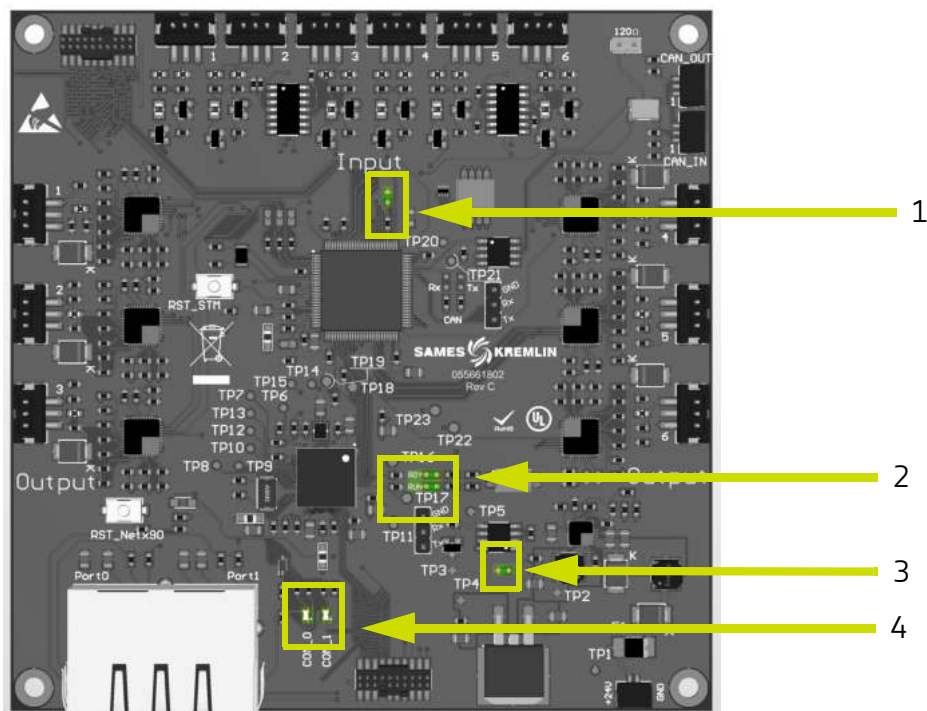

#	LED status	Description
1	red LED	When ON it signals that the program is running. It blinks when 3 times slowly during the board boot. It blinks fast during the board identification (See. Identify in Maintenance on CCB).
2	LED RUN (green)	This LED indicates the state of the EtherCAT chip. When ON it signals that the chip is operational to run.
2	LED RDY (orange)	When ON (whether it blinks or flashes or is on), it signals that the EtherCAT chip is not running. <ul style="list-style-type: none"> <li>User should check that both switches (See 2) are set to OFF and reboot the cabinet</li> </ul>
3	red LED	This indicates that the card is powered on.

#	LED status	Description																		
4	LED COM 0 (green/red)	<p>This LED indicates the status of the EtherCAT network.                      Extract from the documentation ETG.1300 S (R) V1.1.1                      When it is green (see below)</p> <table border="1"> <thead> <tr> <th>Indicator states</th> <th>Slave state</th> <th>Description</th> </tr> </thead> <tbody> <tr> <td>Off</td> <td>Initialization</td> <td>The device is in the INIT state.</td> </tr> <tr> <td>Blinking</td> <td>Pre-operational</td> <td>The device is in pre-operational state</td> </tr> <tr> <td>Single flash</td> <td>Safe operational</td> <td>The device is in state SAFE-OPERATIONAL.</td> </tr> <tr> <td>ON</td> <td>Operational</td> <td>The device is in state OPERATIONAL.</td> </tr> <tr> <td>Flikering</td> <td>Initialization or bootstrap.</td> <td>The device is booting and has not yet entered the entered the INIT state.</td> </tr> </tbody> </table> <p>When red: it is that a critical communication or application error has occurred.</p>	Indicator states	Slave state	Description	Off	Initialization	The device is in the INIT state.	Blinking	Pre-operational	The device is in pre-operational state	Single flash	Safe operational	The device is in state SAFE-OPERATIONAL.	ON	Operational	The device is in state OPERATIONAL.	Flikering	Initialization or bootstrap.	The device is booting and has not yet entered the entered the INIT state.
		Indicator states	Slave state	Description																
		Off	Initialization	The device is in the INIT state.																
		Blinking	Pre-operational	The device is in pre-operational state																
		Single flash	Safe operational	The device is in state SAFE-OPERATIONAL.																
		ON	Operational	The device is in state OPERATIONAL.																
		Flikering	Initialization or bootstrap.	The device is booting and has not yet entered the entered the INIT state.																



Position of connectors

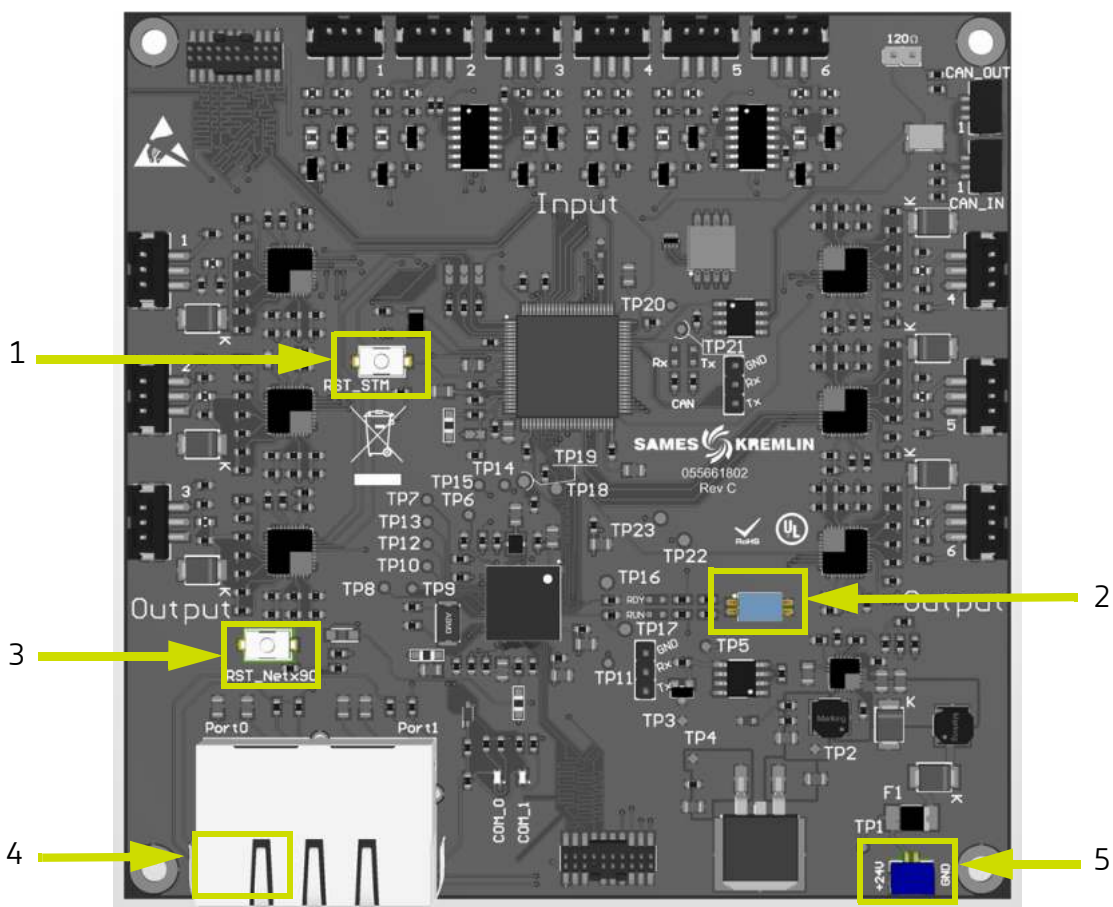

#	Description
1	Main chip reset button
2	EtherCAT switches.
3	EtherCAT chip (netx90) reset button
4	EtherCAT input port (port 0, on the left)
5	Power connector (24V)

### 2.3.2.3. NIOB card description

The NIOB (New Input Output Board) is a board with 10 digital inputs (24V) and 10 digital outputs (24V). On the Cyclomix Evo the board can be found in the departed cabinet. It is used to capture the input signal received when the user select a button (using the magnet).

It is connected to the mother board (CCB) via a ribbon cable.

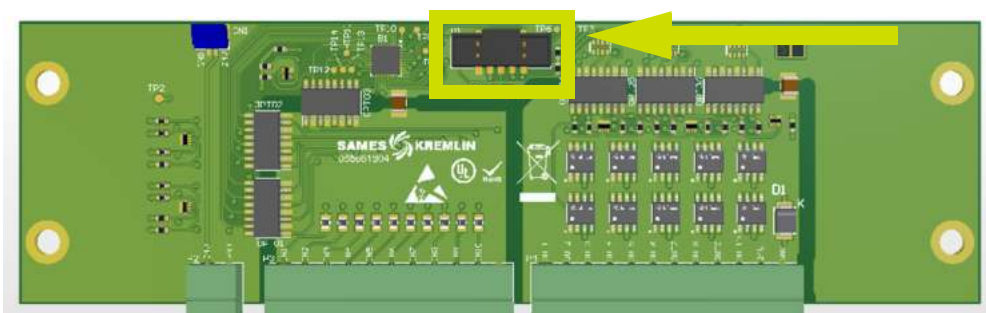
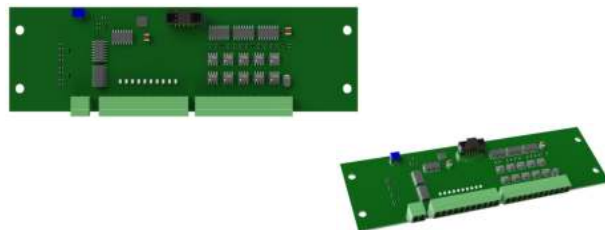

### LED description

This board has no real status LED. The LEDs indicate if an I/O is powered.

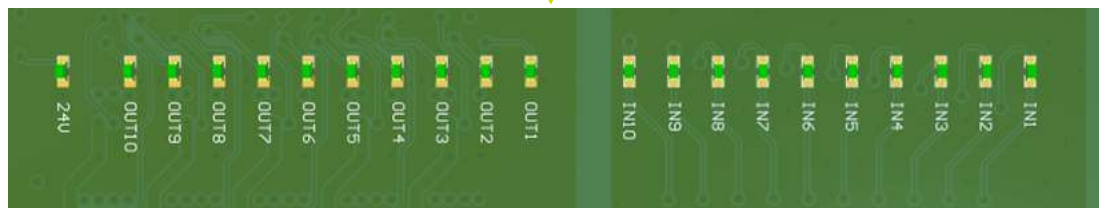
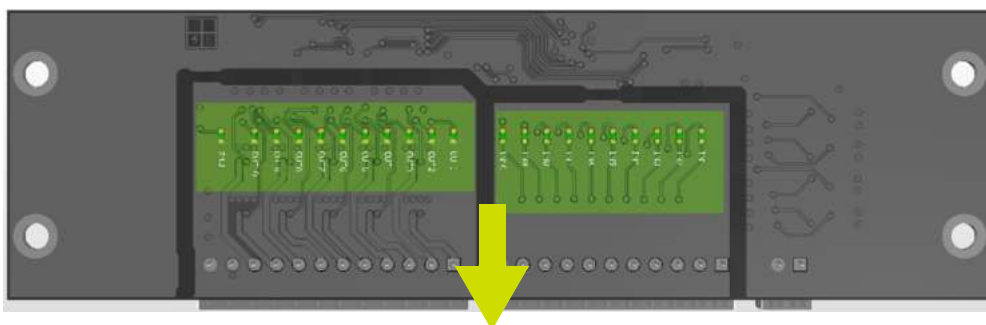

LED status	Description
24 V (red)	The outputs are powered (output will be able to give 24V)
OUT1 (green)	OUT1 is driven to 24V
OUT2 (green)	OUT2 is driven to 24V
OUT3 (green)	OUT3 is driven to 24V
OUT4 (green)	OUT4 is driven to 24V
OUT5 (green)	OUT5 is driven to 24V
OUT6 (green)	OUT6 is driven to 24V
OUT7 (green)	OUT7 is driven to 24V

LED status	Description
OUT8 (green)	OUT8 is driven to 24V
OUT9 (green)	OUT9 is driven to 24V
OUT10 (green)	OUT10 is driven to 24V
IN1 (green)	IN1 is driven to 24V
IN2 (green)	IN2 is driven to 24V
IN3 (green)	IN3 is driven to 24V
IN4 (green)	IN4 is driven to 24V
IN5 (green)	IN5 is driven to 24V
IN6 (green)	IN6 is driven to 24V
IN7 (green)	IN7 is driven to 24V
IN8 (green)	IN8 is driven to 24V
IN9 (green)	IN9 is driven to 24V
IN10 (green)	IN10 is driven to 24V

**Position of the connectors**

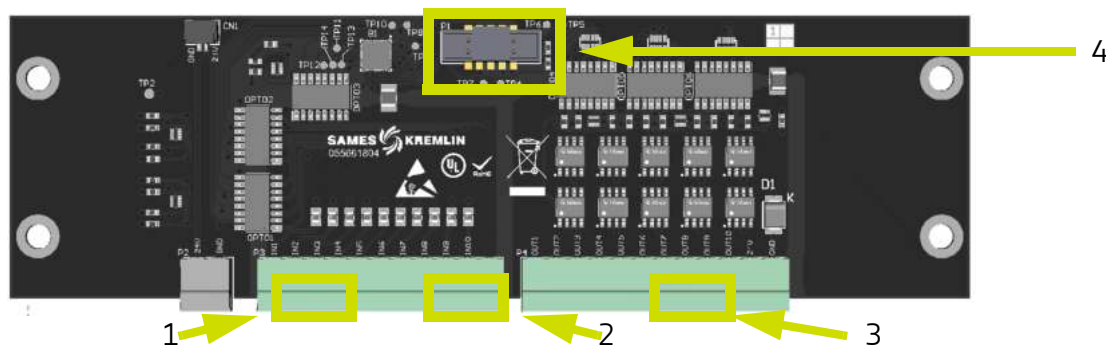

Connectors status	Description
1	Input connectors
2	Output connectors
3	Output power connectors
4	Connector to CCB



#	LED status	Description																		
1	red LED	When ON it signals that the program is running. It blinks when 3 times slowly during the board boot. It blinks fast during the board identification (cf. Identify in Maintenance on CCB).																		
2	LED RUN (green)	This LED indicates the state of the EtherCAT chip. When ON it signals that the chip is operational to run.																		
2	LED RDY (orange)	When ON (whether it blinks or flashes or is on), it signals that the EtherCAT chip is not running. <ul style="list-style-type: none"> <li>• User should check that both switches (cf. 2) are set to OFF and reboot the cabinet.</li> </ul>																		
3	red LED	It shows that the board is powered.																		
4	LED COM 0 (green/red)	<p>This LED indicates the status of the EtherCAT network. Extract from the documentation ETGETG.1300 S (R) V1.1. When it is green (see below)</p> <table border="1"> <thead> <tr> <th>Indicator states</th> <th>Slave state</th> <th>Description</th> </tr> </thead> <tbody> <tr> <td>Off</td> <td>Initialization</td> <td>The device is in the INIT state.</td> </tr> <tr> <td>Blinking</td> <td>Pre-operational</td> <td>The device is in pre-operational state</td> </tr> <tr> <td>Single flash</td> <td>Safe operational</td> <td>The device is in state SAFE-OPERATIONAL.</td> </tr> <tr> <td>ON</td> <td>Opérational</td> <td>The device is in state OPERATIONAL.</td> </tr> <tr> <td>Flikering</td> <td>Initialization or bootstrap.</td> <td>The device is booting and has not yet entered the entered the INIT state.</td> </tr> </tbody> </table> <p>When red: it is that a critical communication or application error has occurred.</p>	Indicator states	Slave state	Description	Off	Initialization	The device is in the INIT state.	Blinking	Pre-operational	The device is in pre-operational state	Single flash	Safe operational	The device is in state SAFE-OPERATIONAL.	ON	Opérational	The device is in state OPERATIONAL.	Flikering	Initialization or bootstrap.	The device is booting and has not yet entered the entered the INIT state.
Indicator states	Slave state	Description																		
Off	Initialization	The device is in the INIT state.																		
Blinking	Pre-operational	The device is in pre-operational state																		
Single flash	Safe operational	The device is in state SAFE-OPERATIONAL.																		
ON	Opérational	The device is in state OPERATIONAL.																		
Flikering	Initialization or bootstrap.	The device is booting and has not yet entered the entered the INIT state.																		



Position of the connectors

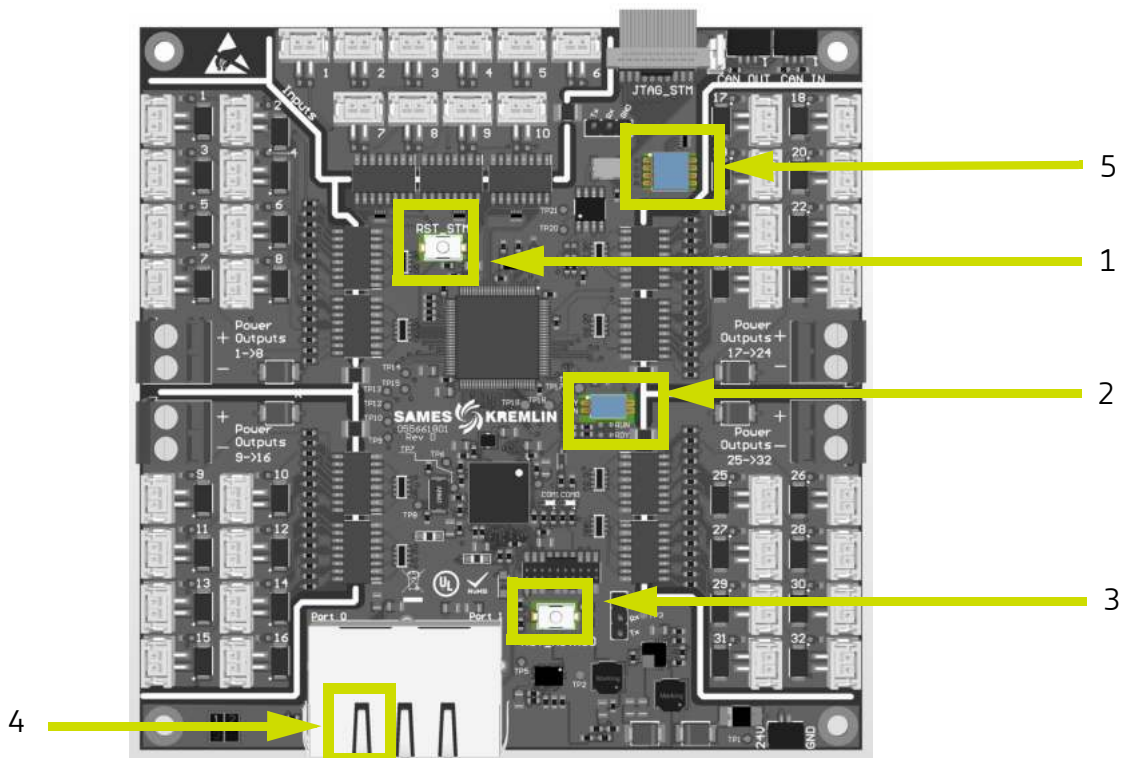

Connectors status	Description
1	Main chip reset button
2	EtherCAT switches
3	EtherCAT chip (netx90) reset button
4	EtherCAT input port
5	Board switches: <ul style="list-style-type: none"> <li>• All set to OFF for the main DIOB.</li> <li>• At least one set to ON for DIOB extension board (DIOB_T).</li> </ul>

## 2.4. Principle of designation and codification

A Cyclomix<sup>®</sup> Evo is made up of a product board and a control box that allows all the elements on the product board to be controlled.

These 2 elements constitute a set with a commercial reference and which is described by a significant designation.

The significant designation is a code that allows the Cyclomix<sup>®</sup> Evo to be defined, manufactured and configured in its entirety. It can be built using the configurator provided by **SAMES**.

As well as the complete assembly, the product board and the cabinet are also defined by a meaningful designation.

Each meaningful designation is associated with a part number and a trade name.

### 2.4.1. Principle of significant designation of the Cyclomix<sup>®</sup> Evo

#### Codification of the board and box assembly

The meaningful designation is composed of 59 characters that allow the Cyclomix<sup>®</sup> Evo to be defined, manufactured and configured in its entirety.

The meaningful designation of a Cyclomix<sup>®</sup> Evo is divided into 9 groups, each defining a part of the dosing unit.

These 9 groups are preceded by a prefix: #EVO-.

The first group gives information about the technology, it allows to define the number of components, the admissible product pressure and the type of platinum.

The second, third and fourth groups allow to define the different components base, catalyst and diluent.

The fifth group is for injection and mixing.

The sixth group concerns the product regulation.

The seventh group concerns the management of paint circuits.

The eighth group concerns the options.

The ninth and last group concerns the management box.

Example of a significant designation.

Prefix	Technology	Comp. A	Comp. B	Comp. C	Injection and mixing	Product regulation	Painted circuits	Options	Control panel
#EVO	- 3XM	- 04X131	- 02X131	- 02X161	- 3232H1H1	- A4	- 10001	- 21000RX	- 12

#### Technology block

The "technology" block is composed of 3 characters:

The first character concerns the number of components managed by the Cyclomix<sup>®</sup> Evo.

The second character concerns the type of platinum and the material of the components.

The third character concerns the maximum allowable working pressure.

Number of components		Type of plate		Working pressure	
2	2 components (A + B)	X	Injection block in stainless steel 303	M	Maximum pressure 240b
3	3 components (A+B+C)	S	Injection block in stainless steel 316		
		C	Box only		
		P	PH compatible (Injection block, 303 stainless steel on base side and 316 stainless steel on catalyst side)		

### Component blocks (Comp. A / Comp. B / Comp. C)

The "component" blocks are composed of 6 characters:

- The first 2 characters concern the number of products that can be connected to this component (products and solvents included).
- The 3<sup>rd</sup> character indicates the presence or not of a filter on the component.
- The 4<sup>th</sup> character indicates the type of flow meter installed on the component.
- The 5<sup>th</sup> character indicates the size of the flowmeter installed on the component.
- The 6<sup>th</sup> character indicates the type of fitting installed on the shade changer.

Number of products		Product filter		Flowmeter type		Size and material of flowmeter		Type of connections on the color changers	
01	1 product	X	No filter	1	ATEX gear flowmeter	1	0.07cc/teeth Stainless steel 303	0	CTM Inox 303 without fitting
--		F	Pencil filter	2	NONATEX gear flowmeter	2	0.12cc/teeth 303 stainless steel	1	CTM Stainless Steel 303 1/2 JIC 303 fittings
99	99 products			3	Débitmètre engrenage ATEX 0.07cc	3	0.24cc/teeth 303 stainless steel	2	CTM Inox 303 fittings 3/8 NPSM 303
				4	NONATEX gear flowmeter 0.07cc	4	0.07cc/teeth Stainless steel 316	3	CTM Stainless steel 316 1/2 JIC 316 fittings
				5	Fiber optic flowmeter	5	0.12cc/teeth Stainless steel 316	4	CTM Stainless Steel 316 3/8 NPSM 316 fittings
				6	0.07cc fiber optic flowmeter	6	0.24cc/teeth Stainless steel 316	5	CTM Stainless steel 316 without fittings
				7	ATEX mass flowmeter	7	Rheonik RHM-03		
				8	NONATEX mass flowmeter	8	Rheonik RHM-04		



### Injection and mixing block

The block "injection and mixture" is composed of 8 characters:

- The first character indicates the size of the product B injector.
- The second character indicates the type of injection valve for product B.
- The third character indicates the size of the product injector C.
- The fourth character indicates the type of injection valve for product C.
- The fifth character indicates the type of mixer for mixture A+B.
- The sixth character indicates the number of mixers for mixture A+B.
- The seventh character indicates the type of mixer for mixture A+B+C.
- The eighth character indicates the number of mixers for the mixture A+B+C.

Injector size B		Injection valve type B		Injector size C		Injection valve type C		Type of mixer A+B		Injection and mixing		Mixer type A+B+C		Number of mixer A+B+C	
0	None	0	None	0	None	0	None	0	None	1	1 mixer	0	None	1	1 mixer
1	Not used	1	Carbide ball point / PTFE gasket cartridge	1	Not used	1	Carbide ball point / PTFE gasket cartridge	1	Flexible	2	2 mixers	1	Flexible	2	2 mixers
2	Not used	2	Carbide ball point / PTFE gasket cartridge	2	Injector size 45	2	Carbide ball point / GT joint cartridge			3	3 mixers			3	3 mixers
3	Injector size 100	3	Carbide ball point / PTFE gasket cartridge	3	Injector size 100	3	peek / peek pin PTFE gasket cartridge								
4	Injector size 200	4	Carbide ball point / PTFE gasket cartridge	4	Injector size 200	4	peek / peek pin PTFE gasket cartridge								
		5	Carbide ball point / PTFE gasket cartridge			5	Peek / peek pin cartridge seal PTFE Stainless steel 316								

### Product control block

The regulation block is composed of 2 characters.

- The first character corresponds to the type of controller produced.
- The second character indicates the presence or absence of a pressure gauge and the measuring pressure.

Type of regulator		Pressure gauge	
0	None	0	None
2	40-6B piloted regulator	1	0-16B pressure gauge
4	5-40B piloted regulator	2	0-40B pressure gauge
6	5-70B piloted regulator	3	0-160B pressure gauge
8	10-160B piloted regulator	4	0-250B pressure gauge
A	10-200B piloted regulator		

### Painting circuit block

The paint circuit block allows you to define the characteristics of the circuit(s) downstream of the Cyclomix® Evo.

- The first character is used to define the number of circuits (gun).
- The second character is used to define the number and type of fast purge valve.
- The 3<sup>rd</sup> and 4<sup>th</sup> characters are reserves.
- The 5<sup>th</sup> character is used to define the number of atomization air boxes included in the Cyclomix® Evo.

Number of circuit(s)		Number of dump valves		Reserve		Reserve		Atomization air casing	
1	1 gun	0	None	0	-	0	-	0	None
2	2-gun management	1	1 dump valve					1	1 casing
3	Management of 2 guns with flushing	2	2 dump valves					2	2 casings
		3	1 dump valve with flushing						
		4	1 dump valve with flushing						

### Options block

The "Options" block contains various information on the configuration of the Cyclomix® Evo.

- The first character is used to define the length of the pneumatic cables and hoses required between the product board and the control unit.
- The second character is used to define the type of connections installed on the 2-gun management block.
- The third character is used to indicate the presence or absence of pressure sensors.
- The fourth character is used to indicate the presence or absence of temperature sensors.
- The fifth character is reserved for a future function.
- The sixth character indicates the type of management concerning the controllers produced (if present).
- The seventh character is used to specify whether the product board is mounted on a frame.

Length of the cables		2-gun block fittings		Pressure sensor		Temperature sensor		Waste sorting (function to be developed)		Management of product regulators		Frame for product board	
1	5 meters	0	None	0	None	0	None	0	No	0	None	0	None
2	10 meters	1	1/2 JIC 303	1	Pressure sensor 0-16B	1	1 temperature sensor	1	Block 2 outputs with EV	1	Manual control board	1	Product plate on frame
3	15 meters	2	3/8 NPSM 303	2	Capteur de pression 0-250B	2	2 temperature sensors	2	Block 4 outputs with EV	2	Management by proportional valves		
4	20 meters	3	1/2 JIC 316					3	Block 6 outputs with EV				
		4	3/8 NPSM 316					4	EV only without output block				
								5					

### Control box block

The last block is for information about the control box.

- The first character identifies the type of communication present in the box and allowing to communicate with another equipment.
- The second character indicates the number of flowmeters present in the box. These flowmeters, connected to the gun's atomization air, allow the Cyclomix® Evo to know when it is open. This makes it possible to verify the proper functioning of the Cyclomix® Evo and in particular to detect the presence of a leak or the malfunction of a flow meter.
- The third character allows the user to define the type of enclosure and the possibility or not to install the product board in an ATEX zone.

Prefix		Technology		Comp. A	
0	Without communication	0	None	1	CE
1	Ethernet	1	1 air flow switch	2	ATEX
2	Profinet	2	2 air flow switches		
3	Modbus				
4	Reserved				
5	cc-link				

### Codification of the product board

The significant designation of the product board is defined in exactly the same way as the complete Cyclomix® Evo with 2 exceptions:

- The prefix #EVO becomes #EVOP
- The first 2 characters of the block "command box" take fixed values.

In fact, the first character will systematically take the value 9 and the second will be 0.

The last character of this block will be defined in the same way as for the complete Cyclomix® Evo and will notably allow the type of solenoid valve to be defined for the control of the injection valve.

Example of a significant designation for the product board:

Prefix	Technology	Comp. A	Comp. B	Comp. C	Injection and mixing	Product regulator	Painting circuits	Options	Coffret de commande
#EVOP	- 2PM	- 04F131	- 02X163	- 00X000	- 3200H1X0	- XX	- 30002	- 21000RC	- 902

### Codification of the Cyclomix® Evo control box

The significant designation of the control box is composed of 35 characters that allow the Cyclomix® Evo control box to be defined, manufactured and configured in its entirety.

The significant designation of the box is divided into 7 groups, each defining a part of the box.

These 7 groups are preceded by a prefix: **#EVOCTRL-**.

The first group indicates which directive the enclosure is subject to.

This allows to know if the enclosure is equipped with intrinsic barriers or not.

The second group indicates the number of circuits powered by the Cyclomix® Evo.

The third group indicates the type of communication card present in the cabinet.

The fourth group indicates the number of Input/Output cards present in the cabinet.

This information allows you to know, among other things, how many different products can be used.

The fifth group indicates the number and position of the solenoid valve blocks present.

The sixth group indicates the type and position of the flowmeters that can be connected to the box.

- The seventh and last group indicates the number of debistats present in the box..

### Example of configuration

Prefix	Directive	Number of gun(s)	Type of communication	Number of I/O cards	Distribution of the solenoid valve blocks	Type of flowmeters	Number of debistats
#EVOCTRL	- EX	- 2G	- ET	- 1	- 10110000	- GGX	- 2F

Directive		Number of gun(s)		Type of communication		Number of I/O cards		Distribution of the blocks solenoid valves		Type of flowmeters		Number of debistats	
1	EC	1G	1 gun	0	Without communication	1	1 card (11 products)	10100000	Module 1 & 3	GGX	2 Gear flowmeters	0F	Aucun débistat
2	ATEX	2G	2 guns	1	Ethernet	2	2 cards (35 products)	10110000	Module 1,3 & 4	GGG	3 Gear flowmeters	1F	1 débistat
				2	Profinet			11100000	Module 1,2 & 3	MMX	2 Mass flowmeters	2F	2 débistats
				3	Modbus			11110000	Module 1,2,3 and 4	MMM	3 Mass flowmeters		
				4	Reserved			11101000	Module 1,2,3 & 5	FFX	2 fiber optic flowmeters		
				5	cc-link			11101100	Module 1,2,3,5 & 6	FFF	3 fiber optic flowmeters		
								11101110	Module 1,2,3,5,6 & 7	GMX	1 Gear flowmeter + 1 Mass flowmeter		
								11101111	Module 1,2,3,5,6,7 & 8	MGX	1 Mass flowmeter + 1 Gear flowmeter		
		11100100			Module 1,2,3 & 6	GGM	2 Gear flowmeters + 1 Mass flowmeter						
		11100110			Module 1,2,3,6 & 7	GMM	1 Gear flowmeter + 2 Mass flowmeters						
		11100111			Module 1,2,3,6,7 & 8	GMG	1 Gear flowmeter +1 Mass flowmeter +1 Gear flowmeter						
		11111000			4 first modules & 5	MGM	1 Mass flowmeter +1 Gear flowmeter + 1 Mass flowmeter						
		11111100			4 first modules and 5	MMG	2 Mass flowmeters + 1 Gear flowmeter						
		11111110			First 4 modules, 5, 6 & 7	MGG	1 Mass flowmeter +2 Gear flowmeters						
		11111111			First 4 modules, 5, 6, 7 and 8								
		11110100			First 4 modules & 6								
		11110110			First 4 modules, 6 and 7								
		11110111			First 4 modules, 6, 7 & 8								

### 2.4.2. Commercial designation principle of the Cyclomix® Evo.

The commercial designation of a Cyclomix® Evo does not allow for a complete definition of the dosing unit, but it does allow you to know the main characteristics. Example of codification for a 2 component machine:

Cyclomix® Evo 2KST 240 EX 1G A02FG24 B02FG24 A1

Example of codification for a 3 component machine:

Cyclomix® Evo 3KST 240 EX 2G A02FG24 B02FG24 C01FG24 A1

The material designation begins with the Cyclomix® Evo product name followed by the following information below.

- The first set of 4 characters identifies the number of components that can be managed by the Cyclomix® Evo as well as the compatibility with the products.

2KST	2K standard 303	Cyclomix® Evo 2 components with color changers, flowmeters and injection blocks are made of 303 stainless steel.
2KPH	2K PH	Cyclomix® Evo 2 components with color changers and flow meters on side A are made of 303 stainless steel and side B of 316 stainless steel.
2KSS	2K 316	Cyclomix® Evo 2 components with color changers, flowmeters and injection blocks are made of 316 stainless steel.
3KST	3K standard 303	Cyclomix® Evo 3 components with color changers, flowmeters and injection blocks are made of 303 stainless steel.
3KPH	3K PH	Cyclomix® Evo 3 components with color changers and flowmeters on the A&C side are made of 303 stainless steel and on the B side of 316 stainless steel.
3KSS	3K 316	Cyclomix® Evo 3 components with color changers, flowmeters and injection blocks are made of 316 stainless steel.

- The second set of 3 characters identifies the maximum product pressure at the inlet to Cyclomix® Evo. There is only one version with an admissible pressure of 240B.
- The third set of 2 characters identifies the directive to which the Cyclomix® Evo.

CE	CE no ATEX	Cyclomix® Evo built according to the European directive but the product board must be installed in a safe area
EX	CE ATEX	Cyclomix® Evo is built according to the European directive and the product board can be installed in ATEX zone 1

- The fourth set of 2 characters identifies the number of circuits managed by the Cyclomix® Evo.

1G	1 Circuit	The Cyclomix® Evo is configured with a single output circuit. This means that there can be one or more guns, but all powered by the same circuit.
2G	2 Circuits	The Cyclomix® Evo is configured to manage 2 output circuits. These 2 circuits will be managed for the flushing, priming and Potlife management phases.

- The fifth set, sixth and seventh in the case of a Cyclomix® Evo 3 components, allowing to identify the configuration of each component.  
This includes the number of color changers, the presence or absence of a filter and the type of flow meter.  
The first letter of this set indicates the component.

A	Component A	Means that the following information concerns component A
B	Component B	Means that the following information concerns component B
C	Component C	Means that the following information concerns the component C
01	1 product	Indicates the number of products available for the component
...	to	
99	99 products	
X	No filter	Means that there is no filter installed on the baseline
F	Presence of a filter	Means that a filter is present on the baseline. It is positioned at the output of the color changer.
XXX	None	Means that the Cyclomix® Evo is factory configured without the presence of a flow meter on this component
G07	Gear flowmeter 0.07cc	Means that the Cyclomix® Evo is equipped with a 0.07cc gear flowmeter
G12	Gear flowmeter 0.12cc	Means that the Cyclomix® Evo is equipped with a 0.12cc gear flowmeter
G24	Gear flowmeter 0.24cc	Means that the Cyclomix® Evo is equipped with a 0.24cc gear flowmeter
M03	Mass flowmeter RHM03	Means that the Cyclomix® Evo is equipped with a RHM03 mass flowmeter
M04	Mass flowmeter RHM04	Means that the Cyclomix® Evo is equipped with a RHM04 mass flowmeter

### Commercial name of the board alone

It is also possible to order only the product board, just as for the complete unit the

The commercial designation will only identify the main characteristics.

This trade description contains the same character groups and with the same characteristics as the trade as the trade name for the complete dosing unit. The difference is only in the prefix or Cyclomix® Evo will be replaced by Platine Evo.

Example of codification of a 2 components machine:

- Evo plate 2KST 240 EX 1G A02FG24 B02FG24 A1

### Commercial designation of the box alone

Likewise, a control box sold alone will have its own trade designation.

The commercial designation of the box is divided into 8 groups, each defining a part of the box.

These 8 groups are preceded by a prefix: COFFRET EVO-

- The first group indicates to which directive the enclosure is subject.
- This makes it possible to know if the box is equipped with intrinsic barriers or not.
- The second group indicates the number of paint circuits powered by the Cyclomix® Evo.
- The third group indicates the type of communication card present in the box.
- The fourth group indicates the maximum number of products that can be managed by the box.
- The fifth group indicates if the unit is equipped with the necessary solenoid valves for waste sorting management.
- The sixth group indicates whether the panel allows the management of product regulators via the product board.

- The seventh group indicates the type and position of the flow meters that can be connected to the panel.
- The eighth and last group indicates the number of flow meters present in the cabinet.

Example of configuration:

- Coffret Evo CE 2G ET 6P X R GGX 2F

Directive		Number of gun(s)		Type of communication		Number of products		Waste		Regulator		Type of flowmeters		Number of debistat		
1	EC	1G	1 gun	0	Without communication	6P	6 products	X	Without management of waste sorting	X	Without management of regulators	GGX	2 Gear flowmeters	0F	No debistat	
2	ATEX	2G	2 guns	1	Ethernet	11P	11 products	W	With management of waste sorting	R	With management of regulators	GGG	3 Gear flowmeters	1F	1 debistat	
				2	Profinet	19p	19 products					MMX	Mass flowmeters	2F	2 debistats	
				3	Modbus	27p	27 products					MMM	Gear flowmeters			
				4	Reserved	35p	35 products					ITX	2 fiber optic flowmeters			
				5	cc-link							FFF	3 fiber optic flowmeters			
												GMX	1 Gear flowmeter + 1 Mass flowmeter			
													MGX	1 Mass flowmeter + 1 Gear flowmeter		
													GGM	2 Gear flowmeters + 1 Mass flowmeter		
													GMM	1 Mass flowmeter + 2 Gear flowmeters		
													GMG	1 Mass flowmeter + 1 Gear flowmeter		
													MGM	1 Mass flowmeter + 1 Gear flowmeter + 1 Mass flowmeter		
													MMG	2 Mass flowmeter + 1 Gear flowmeter		
													MGG	1 Mass flowmeter + 2 Gear flowmeters		

## 2.5. Human/Machine Interface and operation

### 2.5.1. Cutting into 6 worlds

The home screen offers 6 basic features.

- Production menu: set of screens used during the production phases.
- Recipes menu: set of screens allowing the setting of the different recipes.
- Configuration menu: a set of screens used to set up and configure the Cyclomix<sup>®</sup> Evo.
- Consumption menu: set of screens allowing the display of consumption according to different criteria.
- Fountain menu: function allowing the sampling of unmixed product.
- Maintenance menu: set of screens dedicated to maintenance.

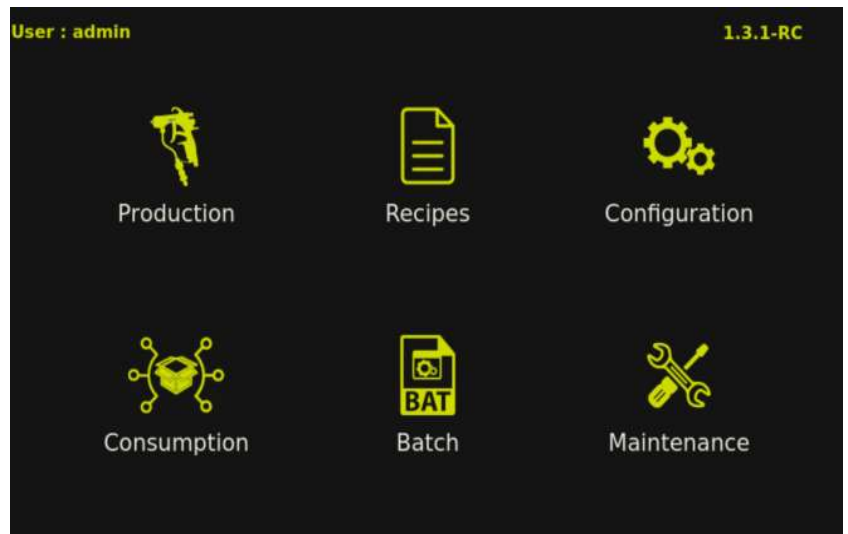

The icons or tabs are tactile. For more details, please refer to the training guides.



### 2.5.2. Configuring the Cyclomix® Evo - General settings

The Configuration mode technically defines the Cyclomix® Evo according to the user's choices. Access to the Configuration mode according to the screens below.

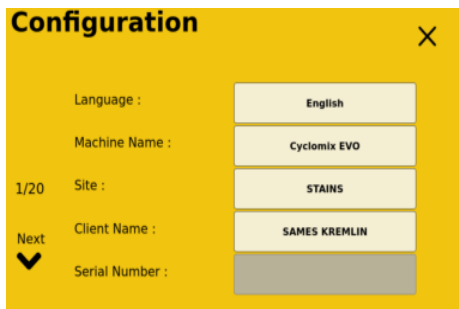
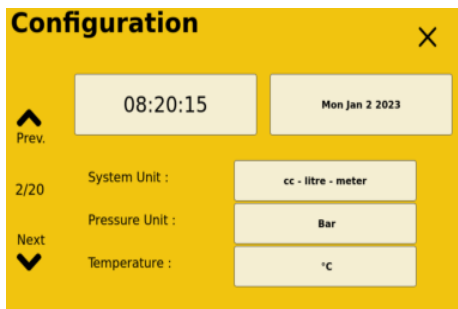

Information provided	Explications	
Language of use Equipment naming Time and date Operating site Customer name Serial number	Traceability of information and identity of the equipment in the user's language. These parameters must be filled in for the first start-up.	
	Example(s) of screen(s)	
	 <p>This screenshot shows the 'Configuration' screen at step 1/20. It has a yellow background and a close button (X) in the top right. The fields are: Language (English), Machine Name (Cyclomix EVO), Site (STAINS), Client Name (SAMES KREMLIN), and Serial Number (empty). Navigation buttons 'Next' and 'Prev' are visible on the left.</p>	 <p>This screenshot shows the 'Configuration' screen at step 2/20. It has a yellow background and a close button (X) in the top right. The fields are: Time (08:20:15), Date (Mon Jan 2 2023), System Unit (cc - litre - meter), Pressure Unit (Bar), and Temperature (°C). Navigation buttons 'Next' and 'Prev' are visible on the left.</p>

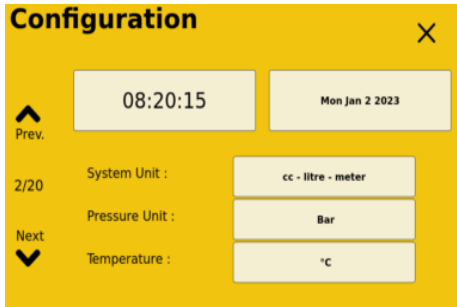
Information provided	Explanations	Example(s) of screen(s)																																			
Unit	<p>The user has the choice of the following units:</p> <table border="1" data-bbox="386 427 909 607"> <thead> <tr> <th>Data</th> <th>Choice 1</th> <th>Choice 2</th> </tr> </thead> <tbody> <tr> <td>Pressure</td> <td>Bar</td> <td>Psi</td> </tr> <tr> <td>Temperature</td> <td>°C</td> <td>°F</td> </tr> <tr> <td>Volume &amp; Length</td> <td>cc/liter/ mm</td> <td>oz/gallons /inches</td> </tr> </tbody> </table>	Data	Choice 1	Choice 2	Pressure	Bar	Psi	Temperature	°C	°F	Volume & Length	cc/liter/ mm	oz/gallons /inches																								
	Data	Choice 1	Choice 2																																		
Pressure	Bar	Psi																																			
Temperature	°C	°F																																			
Volume & Length	cc/liter/ mm	oz/gallons /inches																																			
<p>Depending on the screens and fields, the units displayed will be the following:</p> <table border="1" data-bbox="391 848 904 1487"> <thead> <tr> <th>Data</th> <th>Choice 1</th> <th>Choice 2</th> </tr> </thead> <tbody> <tr> <td>Length</td> <td>meter/mm</td> <td>feet/ inches</td> </tr> <tr> <td>Volume</td> <td>cc/liter</td> <td>oz/gallons</td> </tr> <tr> <td>Flow rate</td> <td>cc/min</td> <td>oz/min</td> </tr> <tr> <td>Length of hose</td> <td>meter</td> <td>feet</td> </tr> <tr> <td>Diamètre de tuyau</td> <td>mm</td> <td>pouces</td> </tr> <tr> <td>Hose diameter</td> <td>cc</td> <td>US oz</td> </tr> <tr> <td>Step flushing</td> <td>cc</td> <td>US oz</td> </tr> <tr> <td>Flowmeter calibration</td> <td>cc/teeth</td> <td>cc/teeth</td> </tr> <tr> <td>Function batch</td> <td>cc</td> <td>US oz</td> </tr> <tr> <td>Maintenance</td> <td>liter</td> <td>US gallons</td> </tr> <tr> <td>Consumption</td> <td>liter</td> <td>US gallons</td> </tr> </tbody> </table>	Data	Choice 1	Choice 2	Length	meter/mm	feet/ inches	Volume	cc/liter	oz/gallons	Flow rate	cc/min	oz/min	Length of hose	meter	feet	Diamètre de tuyau	mm	pouces	Hose diameter	cc	US oz	Step flushing	cc	US oz	Flowmeter calibration	cc/teeth	cc/teeth	Function batch	cc	US oz	Maintenance	liter	US gallons	Consumption	liter	US gallons	
Data	Choice 1	Choice 2																																			
Length	meter/mm	feet/ inches																																			
Volume	cc/liter	oz/gallons																																			
Flow rate	cc/min	oz/min																																			
Length of hose	meter	feet																																			
Diamètre de tuyau	mm	pouces																																			
Hose diameter	cc	US oz																																			
Step flushing	cc	US oz																																			
Flowmeter calibration	cc/teeth	cc/teeth																																			
Function batch	cc	US oz																																			
Maintenance	liter	US gallons																																			
Consumption	liter	US gallons																																			

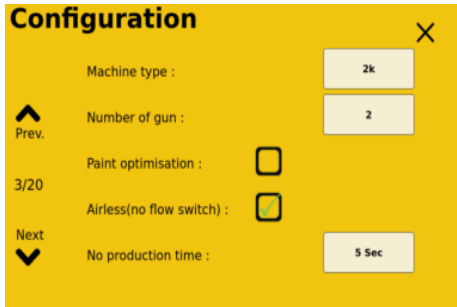
Information provided	Explanations	Example(s) of screen(s)
Type of machine	<ul style="list-style-type: none"> <li>Allows you to define if the Cyclomix® Evo will prepare mono and bi-component products (choice = 2K) or mono, two or three component products (choice = 3K).</li> <li>If 2K, then a certain number of parameters present in the configuration or configuration or recipe screens will be grayed out or absent.</li> <li>The user declares by checking the boxes located on the right of the screens if the elements mentioned are included in his configuration.</li> <li>Depending on the configuration, some screens will not be displayed and some functions will be available or not in some menus.</li> </ul>	
Number of guns	<ul style="list-style-type: none"> <li>This field takes the value 1 or 2 depending on the depending on the number of guns configured.</li> <li>The fields on the other pages concerning the second gun will be grayed out or absent as the case may be.</li> </ul>	
Airless	<ul style="list-style-type: none"> <li>By checking this box, the user specifies that the box cannot receive information about an open gun, either because of the presence of debistats or because of a signal from an external controller (robot, machine, PLC).</li> <li>If this box is checked, it is then necessary to specify a time of "non production".</li> <li>This time corresponds to the maximum time allowed for the Cyclomix® Evo not to receive information from the flowmeters while it is in production.</li> </ul> <p>Example: The value is set to 30 seconds.</p> <p>If the Cyclomix® Evo is in production and does not receive any information from the flowmeters, then after 30 seconds the Cyclomix® Evo will trigger an alarm.</p>	

Information provided	Explanations	Example(s) of screen(s)
FLUSHBOX	<ul style="list-style-type: none"> <li>The FLUSHBOX positions the gun so that the rising and flushing phases occur automatically without the user having to pull the gun trigger.</li> <li>The user uses this FLUSHBOX (check box) during the priming and flushing phases.</li> </ul>	
Dump valve	<ul style="list-style-type: none"> <li>Valve positioned on the circuit upstream of the gun.</li> <li>This valve has a larger flow diameter than the application guns, which allows for an application guns, which allows for faster priming or flushing.</li> </ul>	

Information provided	Explanations	Example(s) of screen(s)
Volumes and dimensions	<ul style="list-style-type: none"> <li>Describe the different volumes in the dosing system.</li> <li>The dimensions to be filled in concern the part that blinks in red on the screen.</li> <li>Opposite examples of different volumes described.</li> </ul>	

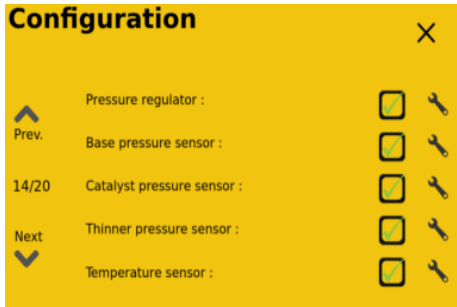
Information provided	Explanations	Example(s) of screen(s)
<p>Pressure Management</p>	<ul style="list-style-type: none"> <li>Define the management of the product pressure inside the Cyclomix® Evo.</li> </ul> <p><b>Pressure regulator</b></p> <ul style="list-style-type: none"> <li>This option corresponds to the addition of pressure regulators positioned between the product feed color changers and the flow meters.</li> </ul> <p>When this option is purchased by the customer, a pressure regulator is positioned on each of the base, catalyst and diluent products.</p> <p><b>Control without proportional valve</b></p> <ul style="list-style-type: none"> <li>The pressure adjustment of these regulators is done via a plate composed of two air regulators with pressure gauges and "or" cells allowing to work according to a working pressure during the phases of calibration of flowmeters, batch, test flowmeter, color rise and production and a rinsing pressure during the flushing phases.</li> </ul> <p><b>Control via proportional valve</b></p> <ul style="list-style-type: none"> <li>In order to have different pressures according to the recipes, it is necessary to be able to control proportional valves.</li> </ul>	

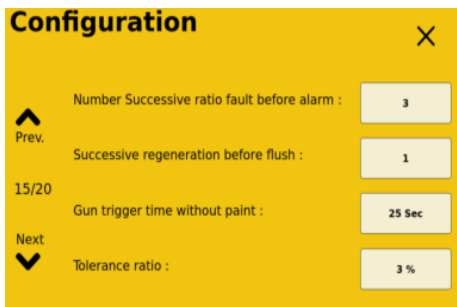
Information provided	Explanations	Example(s) of screen(s)
<p>Number of error ratio before default</p>	<ul style="list-style-type: none"> <li>This parameter corresponds to the number of ratio calculations with an out-of-tolerance result necessary to trigger an alarm.</li> <li>The calculation of the ratio is performed at each injection, if the number of successive injections out of tolerance reaches the number entered, the Cyclomix® Evo triggers an alarm "Ratio error" alarm.</li> </ul>	

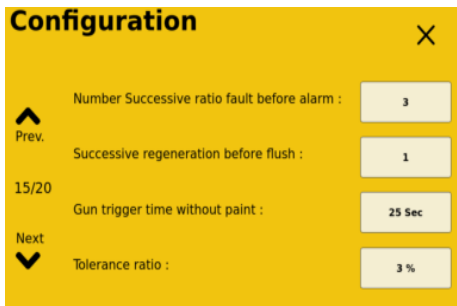
Information provided	Explanations	Example(s) of screen(s)
<p>Number of regeneration before flushing</p>	<p>This parameter corresponds to the number of times the Cyclomix® Evo will regenerate the product when POTLIFE is reached before proceeding to a flushing.</p>	

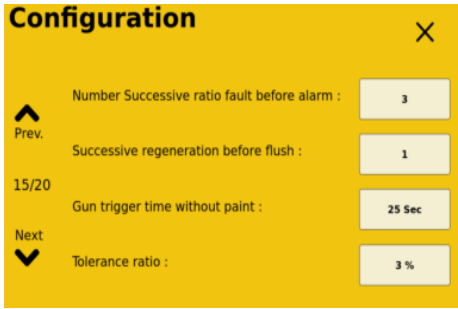
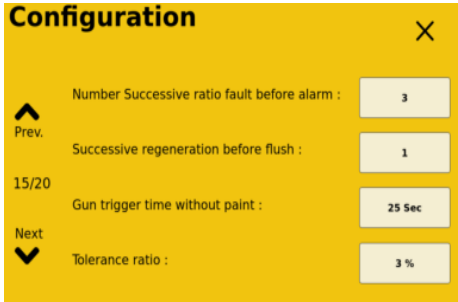
Information provided	Explanations	Example(s) of screen(s)
<p>Gun trigger time without paint</p>	<ul style="list-style-type: none"> <li>• This parameter defines a the paint flow rate while the gun is open. This prevents an error due to the flow-switch detecting a gun opening when the flowmeters are not running.</li> <li>• This time is defined in seconds.</li> <li>• The user can use his manual gun to blow a part before painting it.</li> <li>• It is therefore necessary to be able to inhibit the «flow error» fault during this time.</li> </ul>	 <p>The screenshot shows a 'Configuration' screen with a yellow background. It has a title bar with 'Configuration' and a close button 'X'. On the left, there are navigation arrows: 'Prev.' (up arrow), '15/20' (page indicator), and 'Next' (down arrow). The screen contains four settings, each with a text label and a value input field:</p> <ul style="list-style-type: none"> <li>Number Successive ratio fault before alarm : 3</li> <li>Successive regeneration before flush : 1</li> <li>Gun trigger time without paint : 25 Sec</li> <li>Tolerance ratio : 3 %</li> </ul>
<p>Tolerance ratio</p>	<ul style="list-style-type: none"> <li>• Corresponds to the allowed error on the ratio between the theoretical value and the calculated value.</li> </ul>	 <p>This screenshot is identical to the one above, showing the same 'Configuration' screen. The 'Tolerance ratio' setting is highlighted with a downward arrow next to it, indicating it is the current focus.</p>

### 2.5.3. Calibrate a product

In order to allow a good dosage of the different products, it is imperative that the volumes measured by the flowmeters are very precise.

Depending on the viscosity, the volume per pulse may vary slightly, so it is necessary to calibrate each product.

The calibration of the products is done thanks to the test valves and taps located on the mixing block.

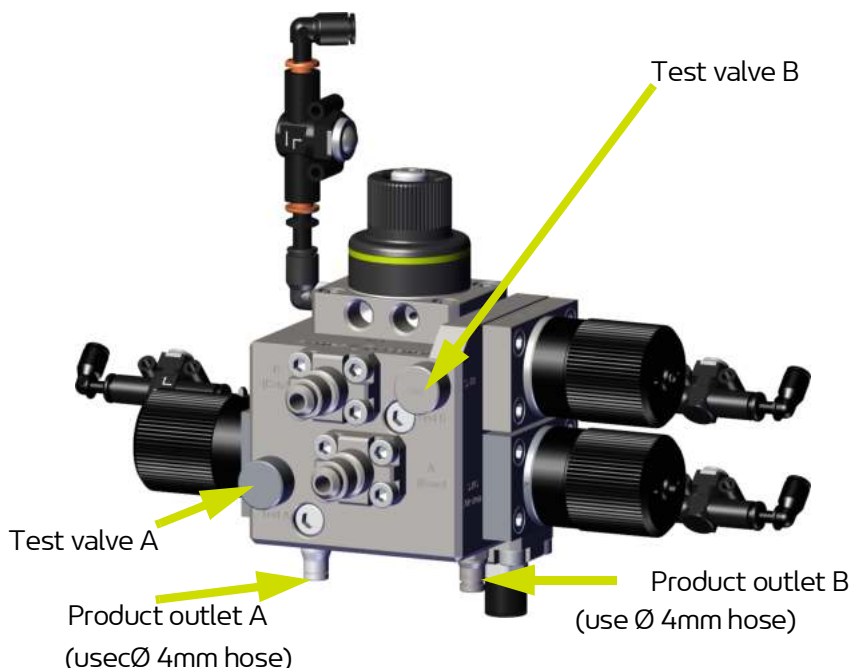

Access to the calibration of a product is done from the configuration menu in the product management pages. (See the Product Management segment)

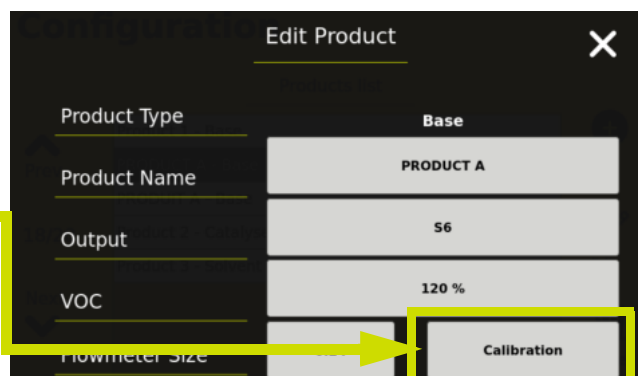
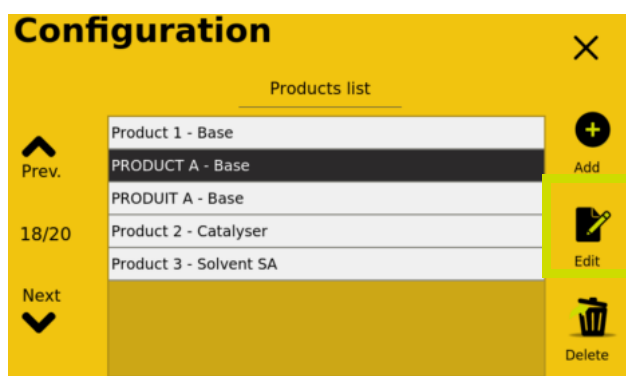

If the calibration value is already known, enter this value directly in the "Flowmeter size" box.

If not, select the calibration function to open the screen allowing to carry out the calibration of the product.

Before performing the calibration of the product, it is necessary to fill the circuit with the product.

Conversely, before leaving the calibration, it is necessary to flush the circuit.

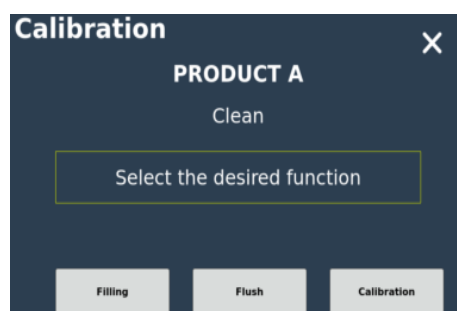

For each phase, follow the instructions on the screen:

**Priming phase**

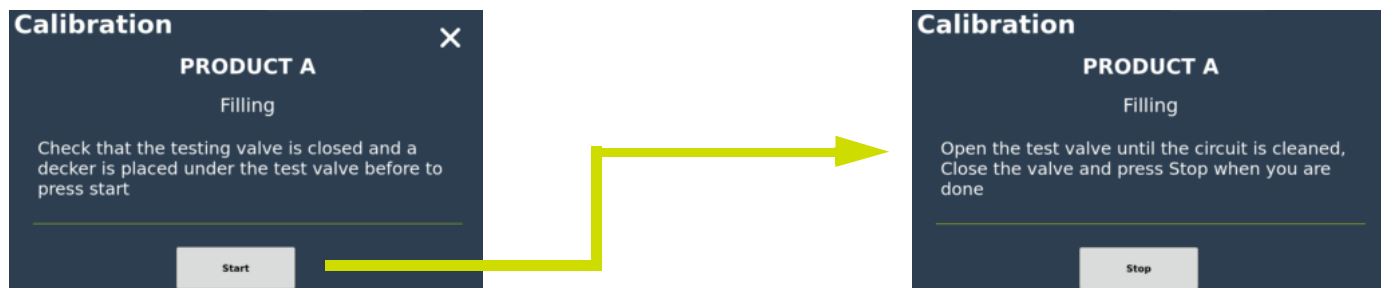

**Calibration phase**

During the calibration phase, the Cyclomix® Evo will flow approximately 1000 pulses of product.

This means, for example, that with a 0.24cc flow meter, the volume obtained will be 240cc.

This product must be delivered in a container in order to measure this volume. Then after entering the actual volume flowed then the machine will calculate the exact volume corresponding to 1 pulse.

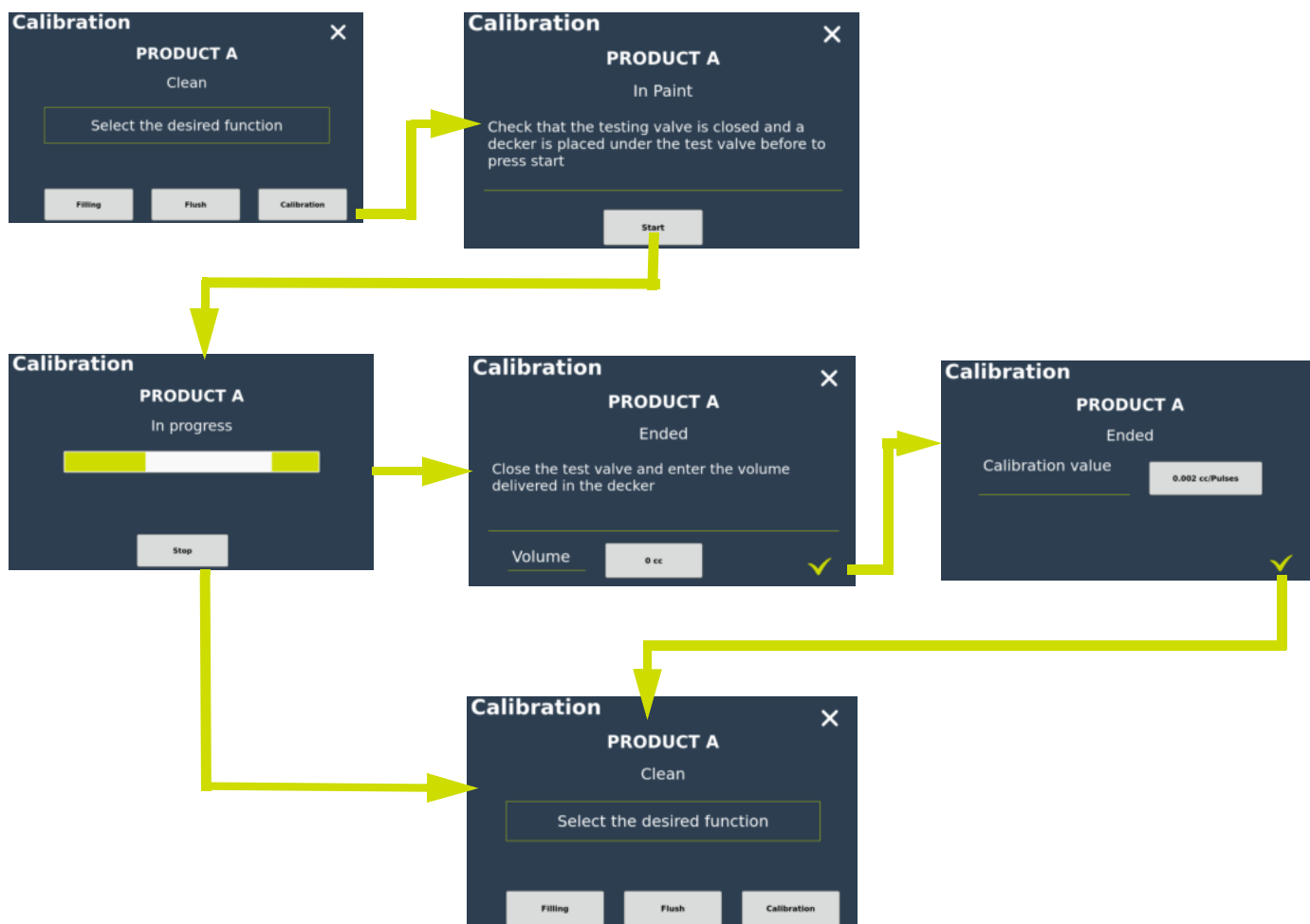



### Circuit flushing phase

The flushing phase is imperative before leaving the calibration mode.

It will not be possible to leave the calibration mode without having performed a flushing.

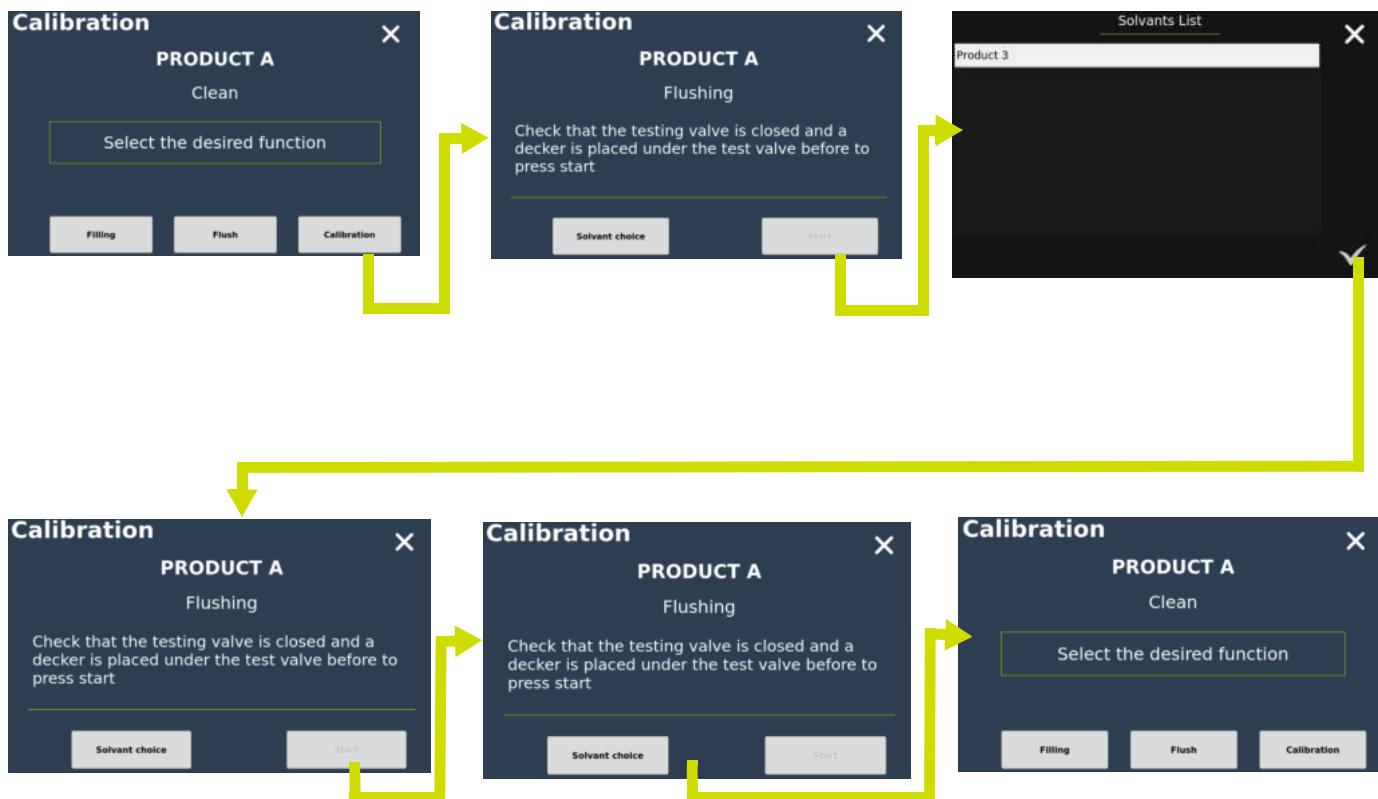

### 2.5.4. Manage recipes

A recipe includes information about the dosage and mixing of products A, B and C in the case of a 3 component mixture.

The information contained in a recipe is:

- The name of the recipe.

- Choosing a product A.

- The choice of a product B.

- The choice of a product C in the case of a 3 components mixture.

- The B/A ratio.

- The C/A ratio in the case of a 3 component mixture.

- The gain for the injection valve B (see glossary for the definition of gain).

- The gain for injection valve C.

- The flushing steps called *production flushing*.

Concerning the gain and flushing, it is possible either to let the machine define these parameters by itself by selecting the autonomous mode or to define each parameter by itself.

2.5.4.1. Edit a recipe

The access to a recipe is done from the main menu and by selecting the *Recipes* icon.

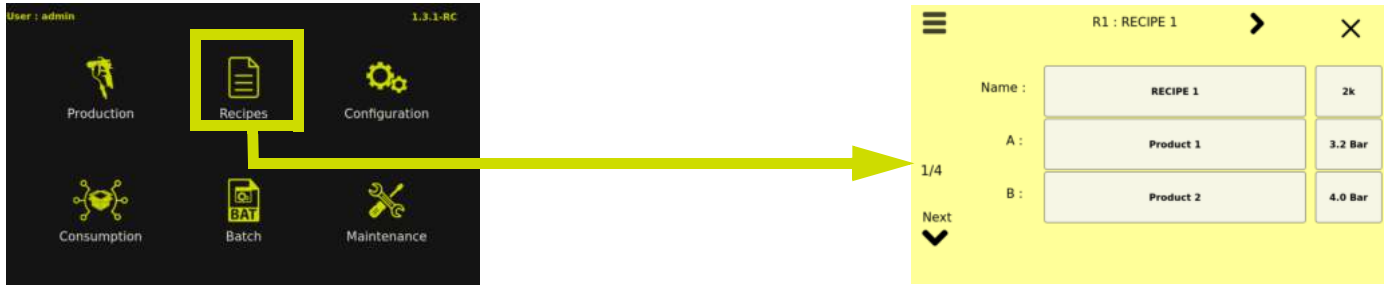

When several recipes have been declared, horizontal arrows allow you to navigate from one recipe to another.

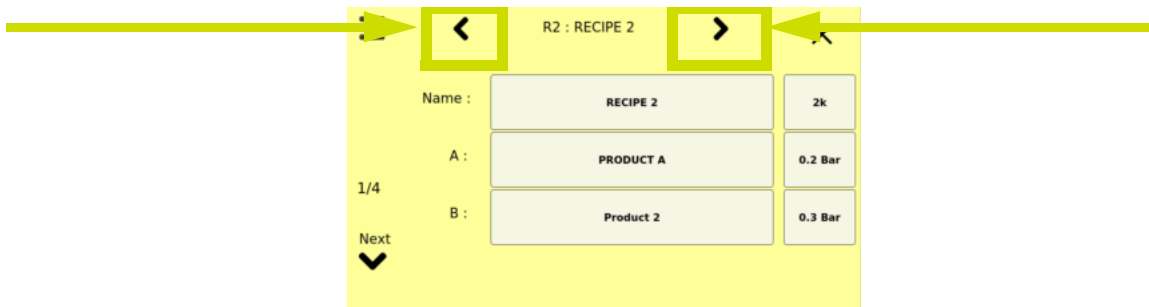

If page 2 of a recipe is displayed then pressing the horizontal arrow will also access page 2 of the new recipe. This allows you to quickly compare the information between each recipe.

- 1 Select the number of components to be mixed.
- 2 Enter the name of the recipe.
- 3 Select each product.
- 4 Enter the required pressure for each product. This value will be the pressure set point when the Cyclomix® Evo is equipped with proportional valves, otherwise it will be given as an indication.

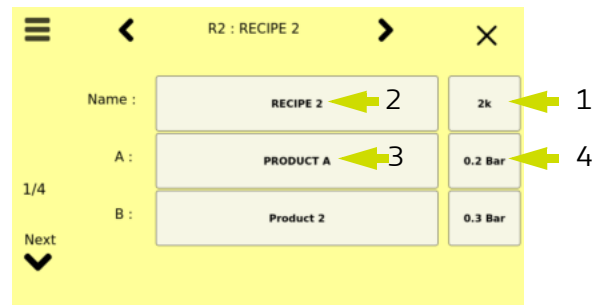

- 1 Enter the ratio of each of the mixtures B/A and C/A in the case of a 3 component product.
- 2 Enter the Potlife value of the mixed product.
- 3 Check this box to have the Cyclomix® Evo define the flushing steps.
- 4 Check this box to have Cyclomix® Evo define the injection frequency.
- 5 Check this box to have a specific flow control for this recipe.

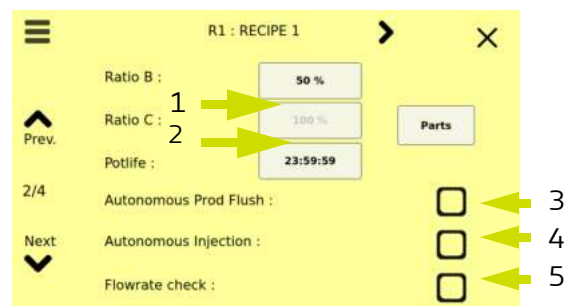

It happens that on the technical data sheets of the products the ratio is declared in parts. By pressing the button "Parts", it is possible to enter this information directly via a specific screen. To define by yourself the injection frequency, uncheck the box "Autonomous injection" to allow access to the configuration page.

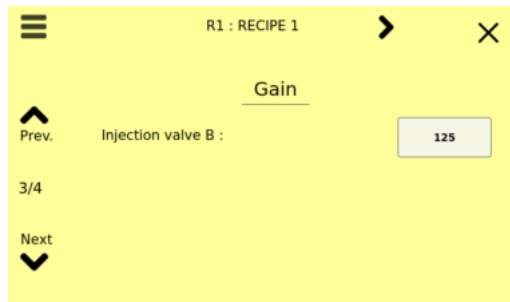

It is also possible to customize the flushing phases.

It is possible to create up to 20 flushing steps.

If the box "Autonomous flushing" is unchecked then a page with 4 flushing steps appears.

If the 4th step is created then a new page with 4 steps appears.



#### 2.5.4.2. Flushing strategy

In order to optimize the flushing process, each stage can be configured with a different flushing strategy.

- The **product** strategy allows to circulate a product during a given time or a defined volume.
- The **air chop** strategy allows to rinse with a mixture of air and solvent. This mixture produces a mechanical action that improves flushing while using a minimum amount of solvent.
- To do this, it is necessary to define the time during which the Cyclomix<sup>®</sup> Evo sends the solvent, then the air injection time and finally the number of air/solvent cycles that will be repeated. It is also possible to insert a time delay between the product and air injection periods. This delay is necessary in the case where the solvent pressure is higher than 6 bars, it allows to make sure that the product pressure inside the circuit is lower than the air pressure, generally at 6 bars.
- The **delay strategy**: during this phase all the control valves are closed to let the solvent have a chemical action on the paint. This will allow the solvent to dilute the paint on the pipe walls.

#### 2.5.4.3. Create, duplicate or delete a recipe

These 3 functions are accessible from the button located at the top left of the recipe screens.

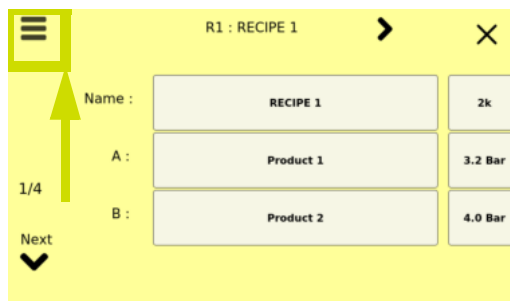

Pressing this button opens the following screen:

- The **New recipe** button allows you to create a new recipe. You will have to fill in all the parameters.
- To simplify the creation of a recipe, it is possible to duplicate an existing recipe and have only a few parameters to modify.
- The **Delete recipe** button allows you to delete the selected recipe.
- Result: regardless of the action performed, a message will appear to confirm the completion of the action.

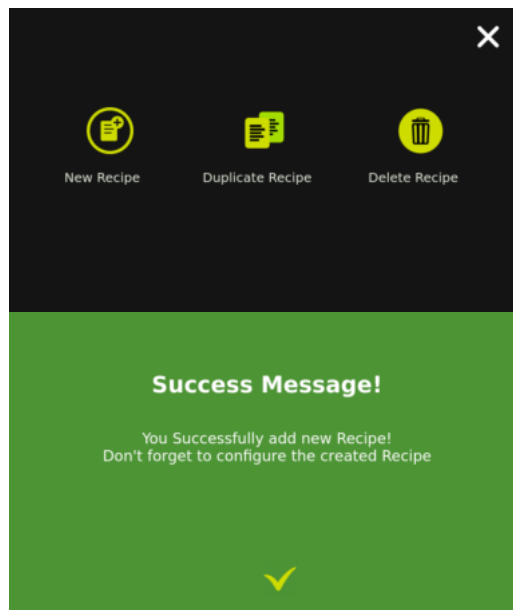

### 2.5.5. Put in product

The use of the product should only be done after the first cleaning as described in the section.

The filling of the circuits from the pump to the Cyclomix® Evo can be done using the **Calibration** function.

The use of the **Calibration** function will first fill the circuit and then calibrate the flowmeters.

The circuit is filled via the test socket using the priming function.

After ensuring that the sampling valve is closed:

- Press the priming button to open the color changer valve and the sampling valve.
- Position a container under the test sockets (using a 4mm outer hose if necessary).
- Then gradually open the tap to circulate the product until it has reached the container.

It is then possible to **calibrate** the product as indicated in the section Calibration of a product or to move on to the next product.

### 2.5.6. Priming

The priming is the phase that consists in filling the supply circuits of the sprayers with mixed paint ready to be applied.

Ready to apply means at the right ratio and the right mix.

The priming phase is managed automatically by Cyclomix<sup>®</sup> Evo.

This means that the Cyclomix<sup>®</sup> Evo will first fill the circuits between the color changers and the mixing block and then fill the mixed circuit.

Depending on the products present in the machine at the time of the recipe call, the filling of circuits A, B or C will be carried out or not.

The volume of priming is automatically calculated by Cyclomix<sup>®</sup> Evo on the basis of the pipe dimensions indicated in the configuration.

The volumes included in the different elements (filter, regulators, flow meters, mixer, etc.) are already taken into account by the machine.

To these volumes will be added the volumes corresponding to the hoses between the Cyclomix<sup>®</sup> Evo and the sprayer(s) as well as any hoses added between the mixer and the 2-gun block or between the color changers and the flow meters.

It is recommended to always perform the priming phase with the gun nozzle in place.

Without the nozzle, the flow rate could be too high and result in a non-homogenous mixture.

### 2.5.7. Production flushing

The production flushing is a flushing phase that can be configured for each recipe. This flushing phase consists of a number of configurable steps. Up to 20 flushing steps can be configured per recipe. Each flushing step will be defined by a strategy and parameters inherent to each strategy. The production flushing can be started in 2 ways:

- Automatically when a new recipe is requested while a recipe is in progress.
- Manually by pressing the **Production Flushing button** on the recipe selection page.

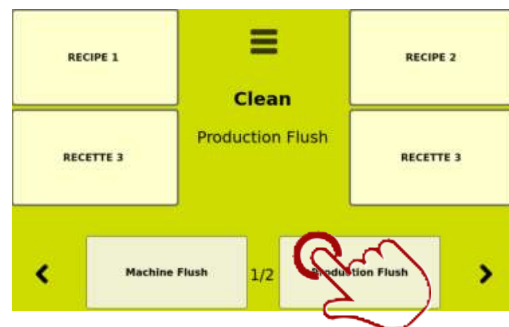
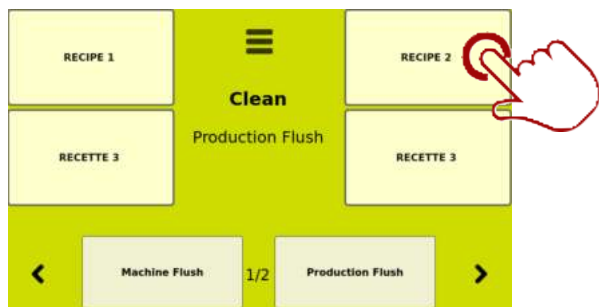

#### 2.5.7.1. Product strategy

This strategy allows to circulate product from one of the color changers. It is possible to configure this cycle to measure a volume of product or to circulate product for a defined time.

The different parameters to be filled in to define a flushing step are:

- The circuit to be cleaned..
- The product to be used.
- The expected volume or opening time of the product valve.
- The equipment through which the product is to be discharged.

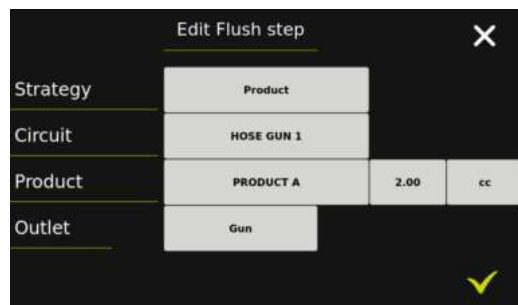

**The circuit**

2 or 3 possible choices depending on the configuration:

- Machine and mixer.
- Gun hose 1.
- Gun hose 2.

If...	Then...
If the circuit is defined as Machine and Mixer.	Therefore, this flushing step will be systematically performed regardless of the gun(s) used during the production phase.
If the circuit is defined as Gun hose 1	So, this step will be performed only if the gun 1 has been used during the production phase.
If the circuit is defined in Gun hose 2	So, this step will be performed only if the gun 2 has been used during the production phase.
If the Cyclomix <sup>®</sup> Evo is defined with 2 guns.	Therefore, it is preferable to define a flushing step with the hose gun 1 and a flushing step with the hose gun 2.
If no flushing step is set for a gun.	Then it will not be possible to start production with this gun. When selecting the gun, an error message will appear to inform the user that no flushing step is defined for this gun.

### The product

The Cyclomix<sup>®</sup> Evo allows the selection of all connected products.

It is therefore possible to choose a product connected to the A, B or C color changer, whether this product is a solvent, a color or a catalyst.

### Volume or time

It is possible to choose a volume of product to be circulated or to define a time during which the product valve will remain open.

When the product passes through the flow meter, it is best to select a volume. This allows the Cyclomix<sup>®</sup> Evo to control that the correct volume of product has passed.

When a time is selected, even if the gun is closed, the time will run out when no solvent has been circulated. There is therefore a risk that the flushing will not be done properly.

#### 2.5.7.2. AIRCHOP strategy

The AIRCHOP strategy corresponds to a cycle where solvent and air are sent in succession. This mixture of air and solvent provides a mechanical action that improves the flushing cycle while consuming a minimum of solvent.

The different parameters to be filled in to define an AIRCHOP step are:

- The circuit to be cleaned. Refer to the appropriate section..
- The product to be used. See the appropriate section.
- The fluid valve opening time.
- Air injection time.
- The number of solvent/air cycles to be performed.
- The time delay between the solvent valve closing and the air valve opening.
- The equipment where the product must be evacuated..

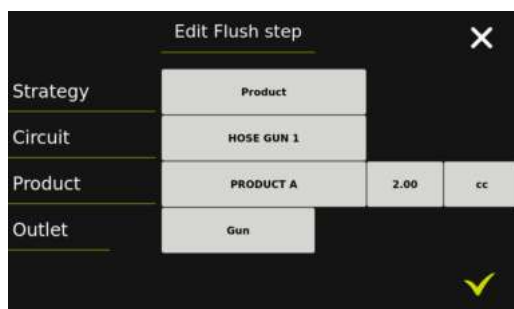

Knowing that the mixture of air and solvent will create disturbances in the circuits, all the cycles are defined by a time. It is therefore not possible to measure the volume of solvent used during this flushing stage..

The **tempo** field is useful mainly when the product pressure is higher than the air pressure. The air pressure is usually set around 6 bar.

When the product pressure is higher than 6 bar, it is then necessary to have a time delay in order to allow the pressure in the circuit to go down below 6 bar and thus allow the injection of air in the circuit.

#### 2.5.7.3. Temporization strategy

Contrary to the "Airchop" strategy which allows to bring a mechanical action to the flushing cycle, the "Temporization" strategy will allow to have a chemical action by leaving the circuit closed during the defined time.

This strategy must always be positioned after a "Product" strategy where solvent has been introduced into the circuit. This delay will allow the solvent to dilute the paint and thus facilitate the cleaning of the hoses wall.

During this delay phase, it is necessary to leave the gun closed. When the Cyclomix<sup>®</sup> Evo is equipped with a flushing box, it will not be controlled during this waiting phase.

#### 2.5.7.4. First stage of flushing

If the paint optimization function has been activated in the configuration menu, then the first step will necessarily be defined with a product strategy and it will only be possible to select a solvent.



### 2.5.8. Machine flushing

The machine flushing is a rinsing phase that can be set from the configuration menu, this flushing will be identical whatever the recipe used.

Like the production flushing, this flushing consists of a number of configurable steps.

Up to 4 flushing steps can be configured.

Each flushing step will be defined by a strategy and parameters inherent to each of these strategies.

These strategies are identical to those detailed in the Production Flushing chapter.

The machine flushing will only be started by pressing the button on the recipe selection page.

The 4 steps of the machine flushing are a complement to the production flushing. This means that the machine flushing will always follow a production flushing or another machine flushing.

- If the machine is in paint with a selected recipe, then pressing the machine flushing button will first cause a production flushing and then a machine flushing.
- If the machine is flushed (production or machine) then pressing the machine flushing button will only involve performing the steps defined in the machine flushing.

### 2.5.9. Change a color

The color change is entirely managed by the Cyclomix<sup>®</sup> Evo.

Thus, to change from a color 1 to a color 2, simply select the new recipe to use..

At the time of choosing a new recipe, the Cyclomix<sup>®</sup> Evo may be in different states. Depending on the state in which the Cyclomix<sup>®</sup> Evo is, it may or may not perform a flushing.

Below are the different cases of color change for a configuration with 2 products (A and B), the principle remains the same for a configuration with 3 products (A, B and C).

	État de la Cyclomix <sup>®</sup> Evo status	Features new recipe	Actions taken
Case n°1	The machine is completely flushed, i.e. all circuits are in solvent.		Filling of circuits A,B then filling of the mixed circuit.
Case n°2	The machine is flushed on the mixed circuit and on the base side	The machine is being painted	Filling the A circuit and then filling the mixed circuit
Case n°3	The machine is being painted	Same products but different ratio different from the previous recipe	Filling the mixed circuit
Case n°4	The machine is being painted	Products A and B different from the previous recipe	Production flushing with flushing of circuit B then filling of circuits A and B then filling of the mixed circuit.
Case n°5	The machine is being painted	Different product A and same product B as the previous recipe	Production flushing without flushing of circuit B then filling of circuit A then filling of the mixed circuit.
Case n°6	The machine is being painted	Different product B and same product A as the previous recipe	Production flushing without flushing of circuit A then filling of circuit B then filling of the mixed circuit.

### 2.5.10. Use the *Batch* function

In order to be able to carry out later touch-ups, it may also be necessary to take the different products separately in order to mix them at the time of the touch-up.  
 The Batch function is the function that enables these these 2 actions. Product sampling using the test valves and taps on the mixing block. on the mixing block.

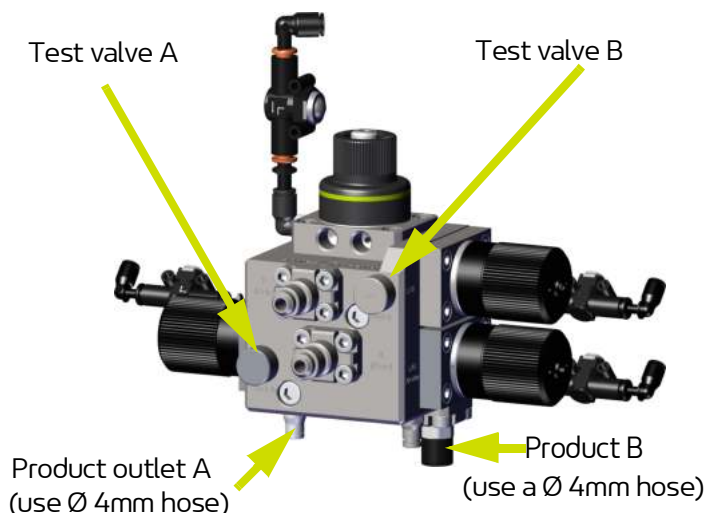

The Batch function can be accessed directly from the main menu.



After selecting the Batch mode, select the recipe from which you wish to take the products.

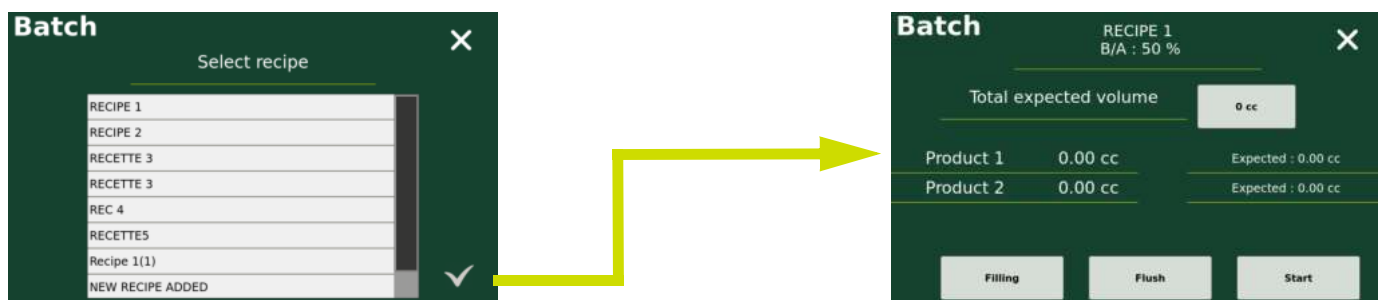

Before sampling the products, it is necessary to fill the circuits with each product.

On the other hand, before leaving the batch function, it will be necessary to flush the circuits.

For each phase, follow the instructions on the screen:

## Priming phase

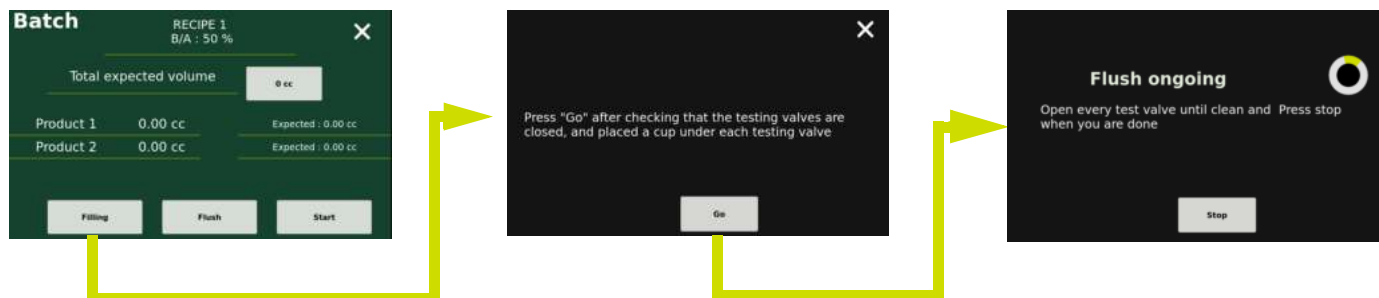

## Sampling phase

In order to start a sampling, it is necessary to have previously indicated the total volume of paint desired. If this is not the case, an alarm message appears on the screen and the function will not start.

This volume corresponds to the total volume desired, depending on the ratio of the selected recipe the expected volumes of each product are displayed.

Then press "Start" and all the information needed to perform the sampling phase will be shown on the screen. The machine will first deliver product A, then product B and finally product C in the case of a 3 component recipe.

Once the machine has finished delivering the different products, the respective volumes of each component are displayed on the screen.

Check that the volumes obtained are equivalent to the volumes displayed by the machine and if this is not the case then it is necessary to recalibrate the flow meter(s) concerned.

### 2.5.11. Manage users

The Cyclomix® Evo allows for the management of several users and it is possible to grant only the desired rights to each one. This allows, for example, to authorize only one person to perform the reset of consumption or access to maintenance functions. The name of the logged-in user is displayed in the top left-hand corner of the main menu screen.

At the delivery of the machine, there is only one user to create with an administrator profile, it is the user "admin" and the associated password is «admin».

#### 2.5.11.1. Access the user menu

Access is gained from the main menu screen by pressing directly on the name of the user currently logged in.

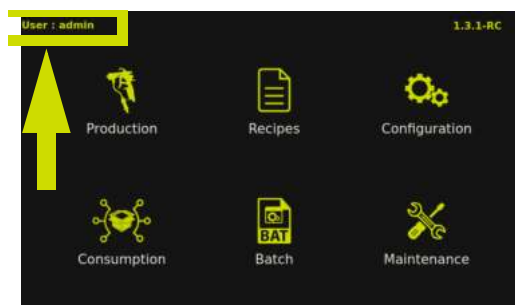
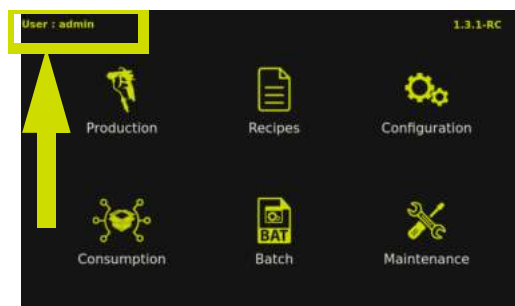

On this screen, it is possible either to disconnect the current user or to connect a new user.

To do this, enter the user name and the associated password.

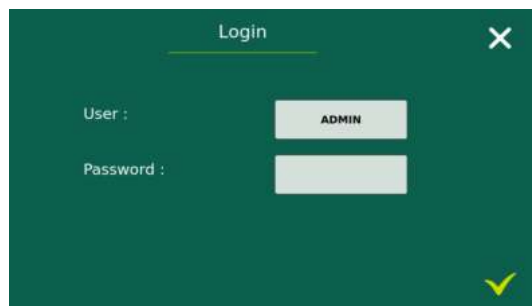

If the user has a "personalized" profile then after validation of his information the menu screen will appear and the menus where the user cannot access will be grayed out.

If the user has an "administrator" profile, then after validation of his or her information, a screen will appear where the user can either go to the user management pages or return to the main menu where he or she can access the various menus of the Cyclomix® Evo.

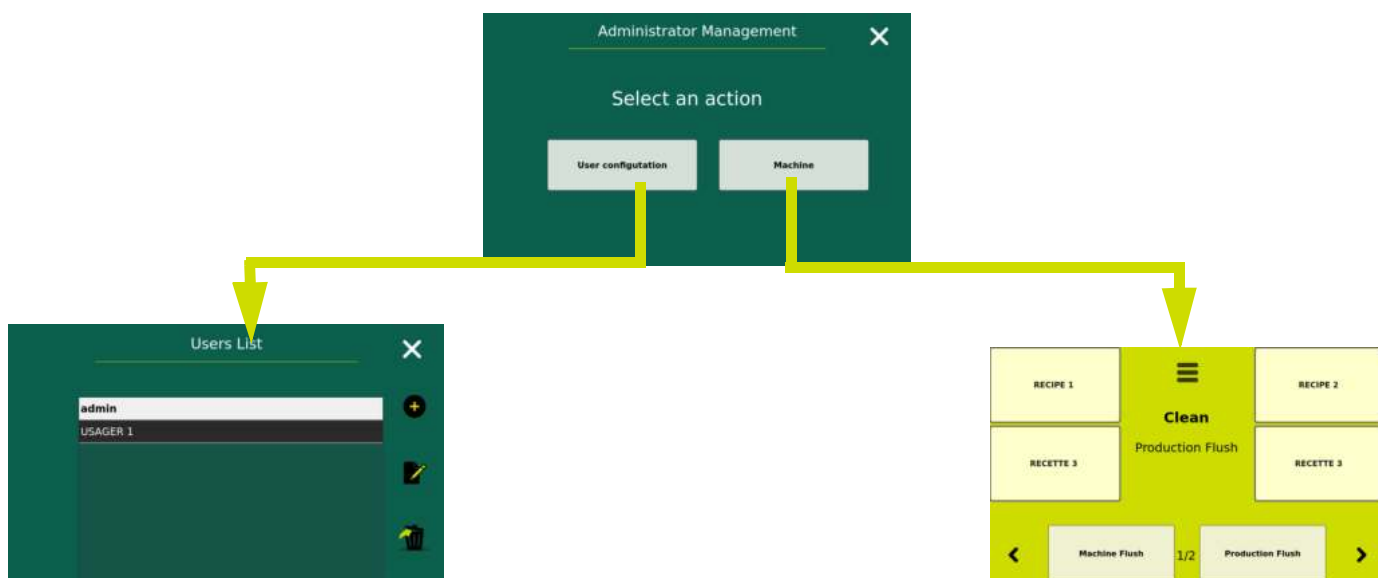

### 2.5.11.2. Create a user

Only an administrator can create a user.

A user is created using the icon  on the User List screen.

A first screen is displayed allowing you to fill in the main information such as the name of the user and the profile of the user (administrator or personalized).

Then the 2 following fields are optional, they are the email address and the password. If there is no password, it means that it will be enough to enter the name of the user on the access screen, the security of the connection of this user is thus limited.

Finally a check mark allows you to define if this user is considered as the default user.



The default user is the user who will be automatically connected when the Cyclomix<sup>®</sup> Evo is started or when another user is disconnected.

When the custom profile is defined then an Access Rights button appears at the bottom of the screen.



This Access Rights button takes you to a new screen to define specific user rights.

It is possible to define different rights for the HMI screens directly on the box and the screens of the smartphone application.

If the boxes are not checked then it means that the user will not have access to them.



In particular, it is possible to grant or not the right for a user to perform a bypass during the priming or flushing phases.

It is also possible to allow a user to visualize the consumptions but without allowing the reset of the different volumes



### 2.5.11.3. Modify or delete a user

Just like creating a user, modifying or deleting a user can only be done by an administrator.

These 2 actions are performed from the *User List* screen.

After selecting the user concerned, simply select the icon 

or to make a change to the user profile



or to delete a user.

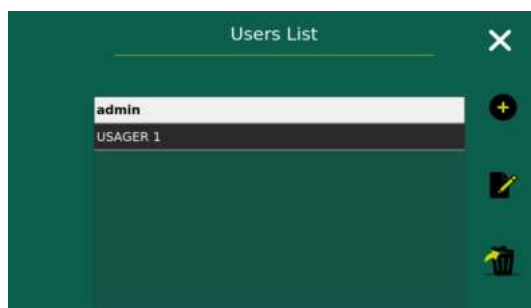

### 2.5.12. Manage consumption

The Cyclomix<sup>®</sup> Evo records the volumes of all products flowing through the flowmeters.

All volumes are divided into 3 categories: volumes by product, volumes by recipe and volumes by lot number.

The access to the consumptions is done from the main menu.

When opening this menu, the interface displays the consumption volumes by recipe.

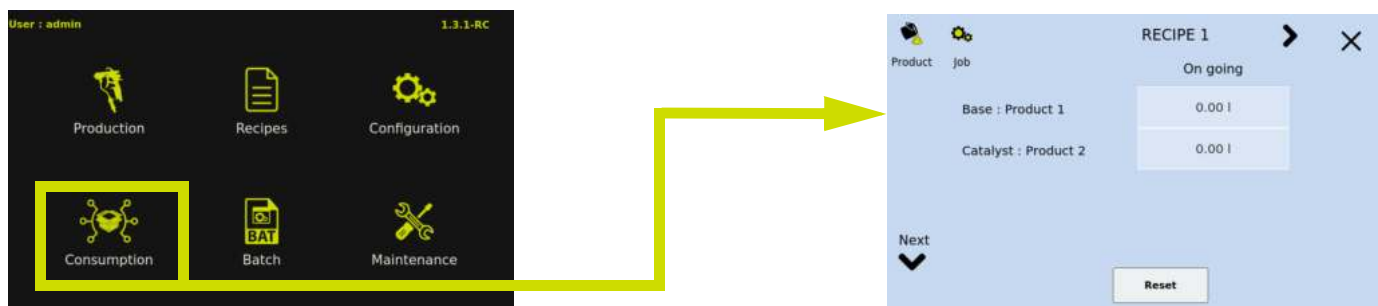



Navigation in the different records.

A system of arrows allows you to navigate through the different screens. The right and left arrows located on the top of the screen allow you to navigate between the recipes and the up and down arrows located on the left of the screen allow you to navigate between the different products.

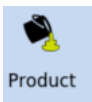

#### 2.5.12.1. Different consumption display modes

The Cyclomix<sup>®</sup> Evo allows the display of consumption by recipe, by product or by batch number (or production order). You can switch from one mode to the other using the icons located on the top left of the screen.

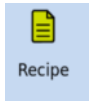
Visual	Explanation
 <p>Product</p>	<p>This icon gives access to the consumption per product. In other words, the volume passed through the machine for each product. As a product can be used in different recipes, in this menu it is possible to see the total volume of this product.</p>
 <p>Job</p>	<p>This icon gives access to the consumption by batch number. This makes it possible to know the total volume of paint applied to a batch.</p>
 <p>Recipe</p>	<p>This icon allows you to access the consumption by recipe and thus see for each recipe the volume of each product and the COV.</p>

### 2.5.13. Exploiting the Production screens

#### 2.5.13.1. Putting a recipe into production

The production of a recipe is very intuitive and is done very quickly from the touch screen.

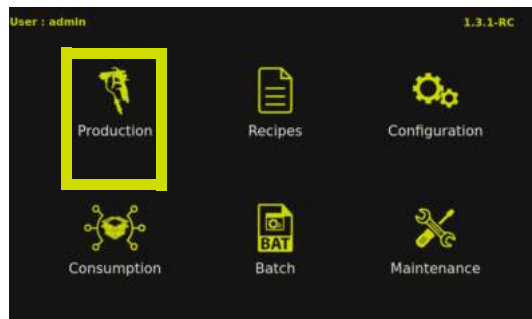

Then it is necessary to select the desired recipe by pressing the corresponding button..

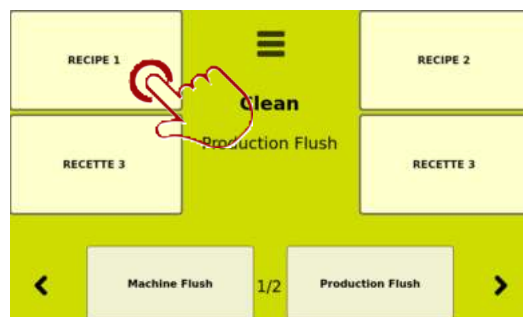

If the machine is equipped with a 2-gun module, then following the selection of the recipe it will be necessary to select the gun or guns that will be used.

If both guns are selected then the priming will be done on both circuits starting with circuit 1 and if not the priming will be done only on the selected circuit.

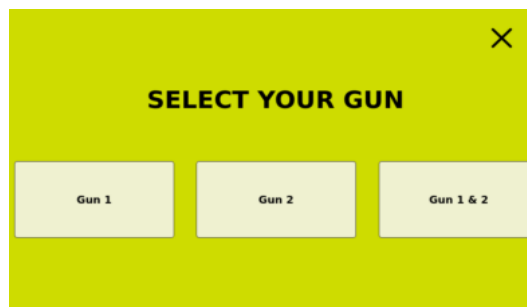

Following the selection of the recipe in the case of a configuration with only one gun or following the selection of the gun(s) in the case of a configuration with two guns, the Cyclomix<sup>®</sup> Evo automatically switches to the priming phase



The priming screen displays a certain amount of information that allows you to follow the evolution of this phase.

Reference points	Designation
1	Indicates the name of the current recipe
2	Bar graph indicating the evolution of the priming
3	Indicates the ratio requested in the recipe with the actual ratio next to it
4	Indicates the evolution of the volume starting from 0
5	Indicates temperature and pressure information
6	Indicates the gun or guns used
7	Button to go directly to production without priming
8	Button to stop the priming and return to the main screen. The machine is considered to be in paint and a flushing cycle will be carried out following the call for a new recipe.

Once the priming is completed, the Cyclomix<sup>®</sup> Evo goes directly to the production phase



### 2.5.13.2. Production screen

The production screen contains a number of production-related information.



Reference points	Designation
1	Indicates the name of the current recipe
2	Bar graph indicating the evolution of the Potlife per gun
3	Indicates the ratio requested in the recipe
4	Indicates the actual ratio during production
5	Indicates the total flow delivered by the machine
6	Indicates the Potlife count per gun
7	Indicates pressure and temperature information - value mentioned in the recipe on the left and actual value on the right (if sensor present)
8	Indicator showing the gun(s) used in the recipe.
9	Button to stop the current production to return to the recipe selection screen.

### 2.5.14. Zoom function on ratio and flow rate

The Cyclomix® Evo allows you to zoom in on the actual ratio or the current flow rate while being a few meters away from the cabinet.

To do this, simply press the value you wish to display.

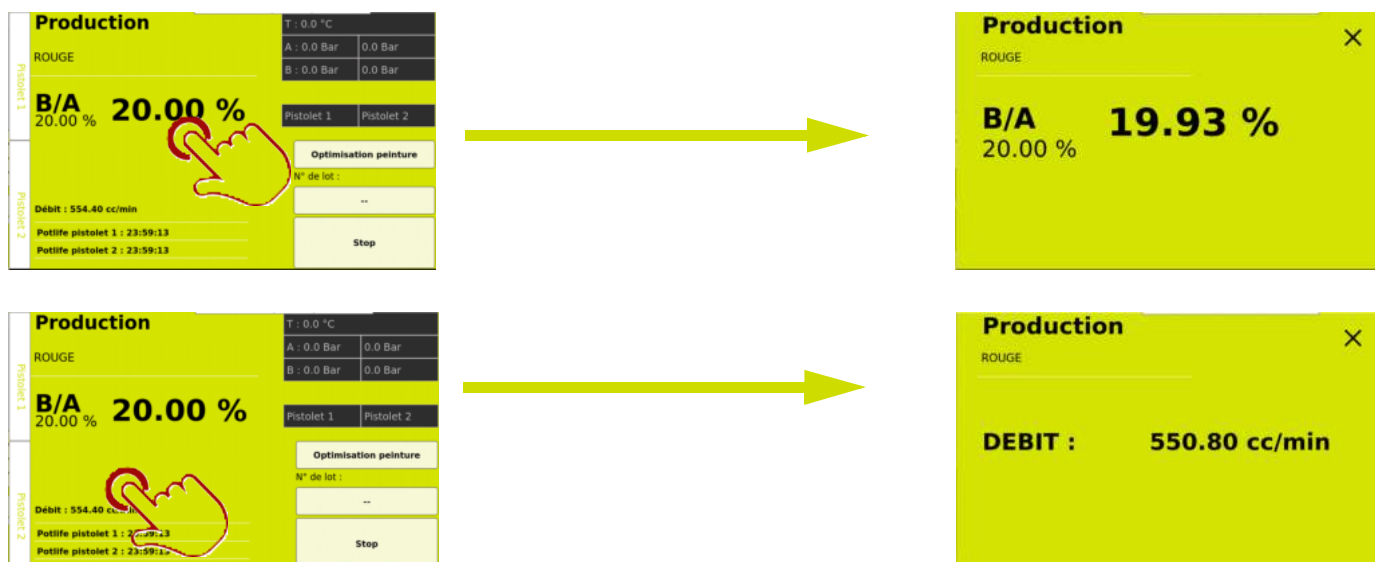

### 2.5.15. Adjusting the ratio in production

It may happen that during production, for example in order to adjust the gloss level of the paint, that it is necessary to slightly correct the mixing ratio.

To do this, simply press the ratio for 2 seconds to enter a new screen allowing you to adjust the percentage of catalyst.

For security reasons, it is not possible to change this percentage by more than 10%.

This new target ratio will only be taken into account during the current production phase. This target ratio will take on the value stored in the recipe parameters as soon as a flushing cycle is performed or a new recipe called.

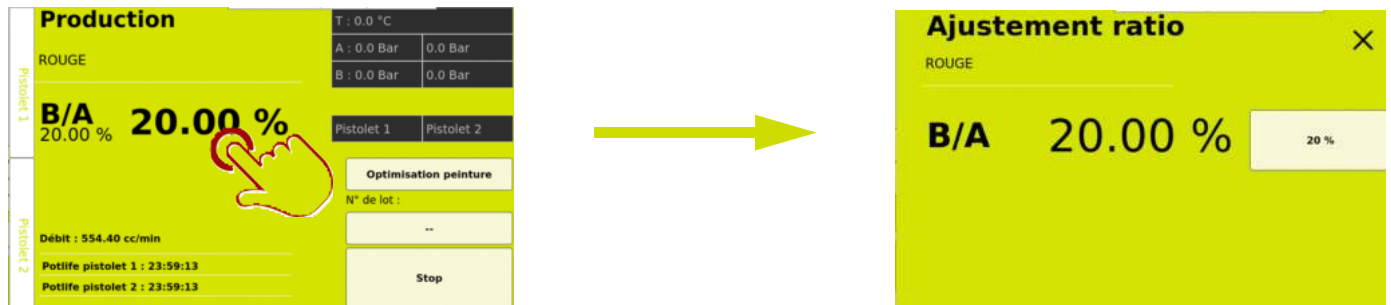

By selecting the box on the right, a keyboard appears allowing you to enter the new desired ratio.

When a ratio correction is requested then the target ratio displayed on the production page is in orange.

### 2.5.16. Register a batch number

In order to have a traceability on the painted parts:

- It is possible to indicate a batch number or production order which will then be recorded in the Excel file of production follow-up.
- It is thus possible to know the volume of paint applied on this batch number, if an alarm has occurred during the application.

To enter a lot number:

- Select the Lot No. button and a keyboard will appear allowing you to write the lot number which can be a mixture of letters and numbers.

Result: The batch number also appears on the display of the device.



### 2.5.17. Paint optimization function

In order to avoid throwing away the volume of paint contained in the hoses at the end of production, the Cyclomix® Evo is equipped with the Paint Optimization function which allows the paint to be pushed with solvent while maintaining the atomization air and high voltage activated.

#### 2.5.17.1. Set the usable volume

The Paint Optimization function is activated from screen 3 of the configuration menu by selecting the corresponding check mark.

Once the check mark is selected, it is possible to enter the percentage of the hose volume that can be used by the Paint Optimization function.

This volume corresponds to the volume of the hose between the mixer and the gun in the case of a 1-gun configuration and to the volume of the hose between the 2-gun management block and the gun in the case of a 2-gun configuration.

By selecting the key next to the volume box, you can then choose how to activate the function.

This can be done either from the HMI, or via a box connected to a digital input or via the remote box if this one is present.

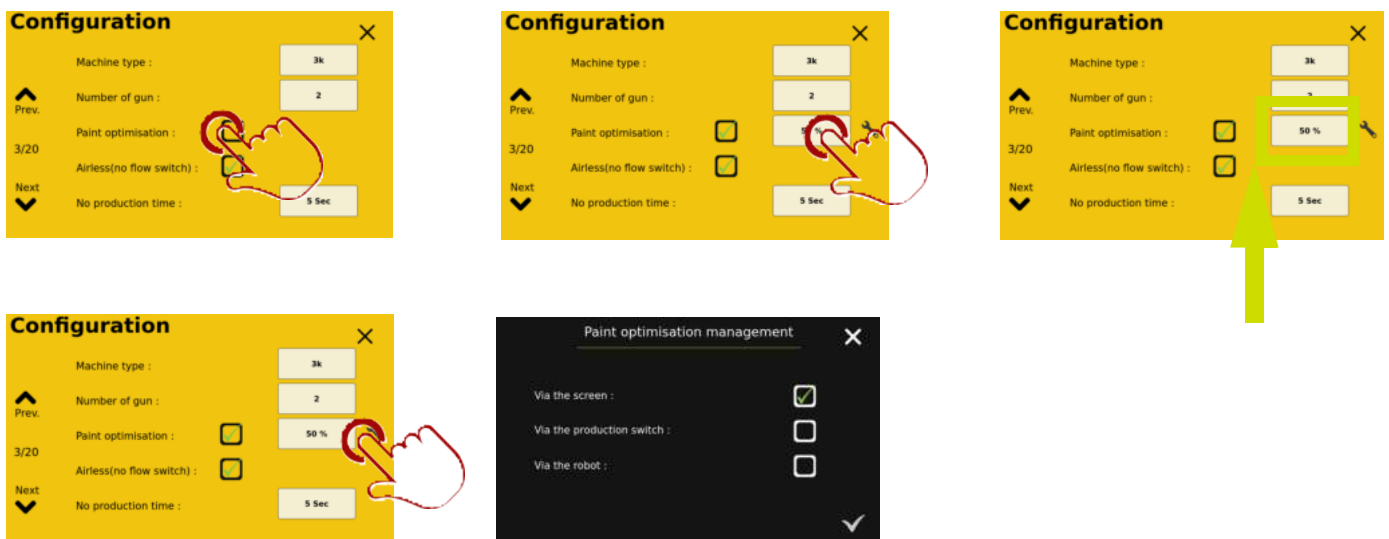

### 2.5.17.2. Enable paint optimization during production

When production of a recipe is almost complete and the volume to be applied is less than the volume available in the hose, the Paint Optimization function can be activated.

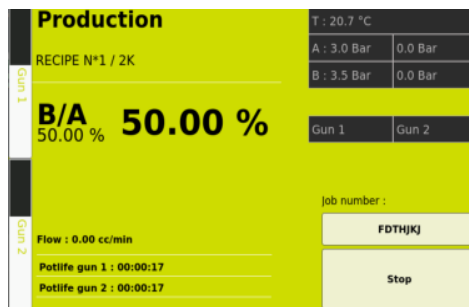

Activation is either via the button on the main or remote display, or via a 24V signal connected to input N°6 for gun 1 and N°7 for gun 2 on the DIOB 1 board in the main cabinet.

Once the function has been activated, the production screen displays the available volumes. There's the volume contained in the machine (volume between injection block and mixer outlet or 2-gun management block, depending on configuration) and the volume contained on each of the circuits.



As the application progresses, the volume of the machine first decreases, regardless of the gun used. Once this volume has been fully used, it changes to 0cc and is written in red.



Then the volume of each circuit will decrease according to the use of the gun (gun open information thanks to the air atomization flow control).

If the Cyclomix Evo is configured in Airless mode, then the volume of the machine that decrements and then the smallest of the volumes of each circuit is taken into account, and only this volume can be consumed, whatever gun is used.

Then 2 cases can occur: All available paint is consumed, or the application is finished before the entire available volume has been used.



As soon as one of the volumes on a circuit is empty, the circuit supply valve closes, the volume displays 0cc and is written in red.

When all available volumes have been used, a screen appears indicating that no more paint is available. Once the message has been validated, the recipe selection screen appears, where you can perform a flushing operation or request the loading of a new recipe.

If the application is finished and paint is still available, simply select the end of production button.

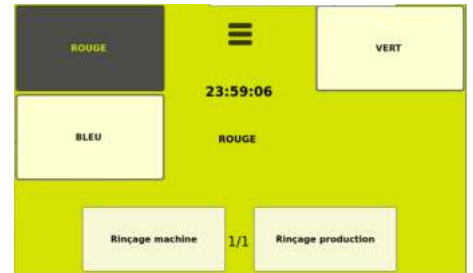
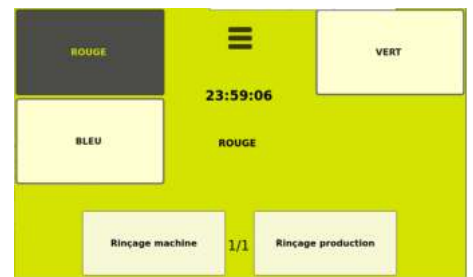
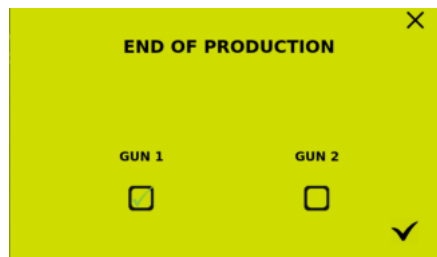

If the configuration is defined with 1 gun, then the recipe selection screen appears and it is possible to select a flushing or a new recipe.

If the configuration is defined with 2 guns, a screen appears with the option of selecting which circuit has finished. If only 1 of the circuits is selected, the screen returns to the production screen and only the volume remaining on the circuit in use is displayed. The valve of the circuit no longer in use is then closed.

Once the 2 circuits have been validated, the recipe selection screen reappears.

## 2.6. Mobile application

The H.M.I. system is also deployed in mobile application mode.

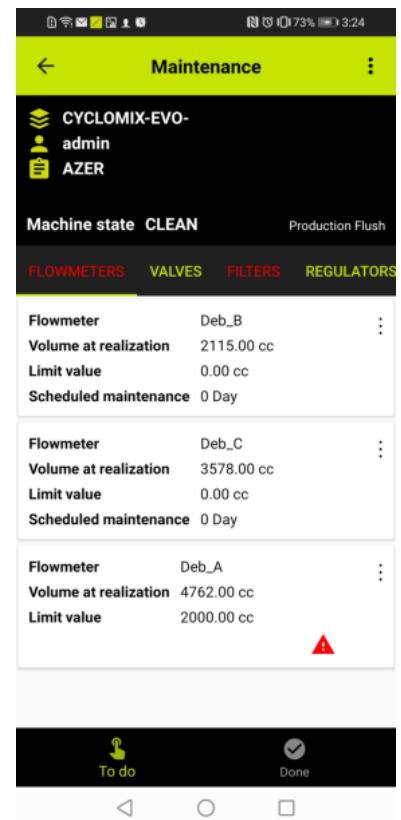
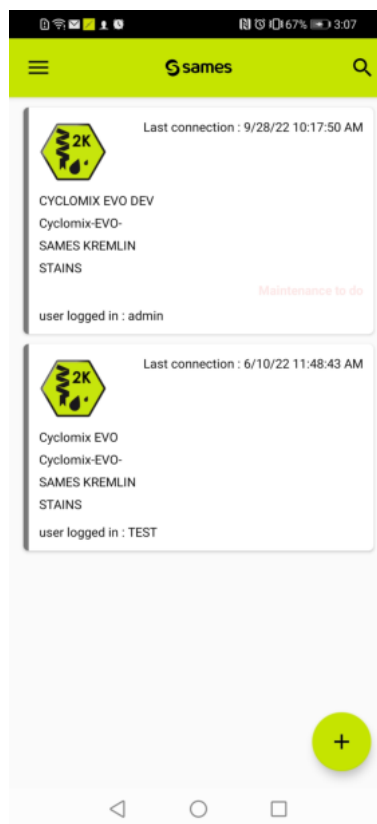
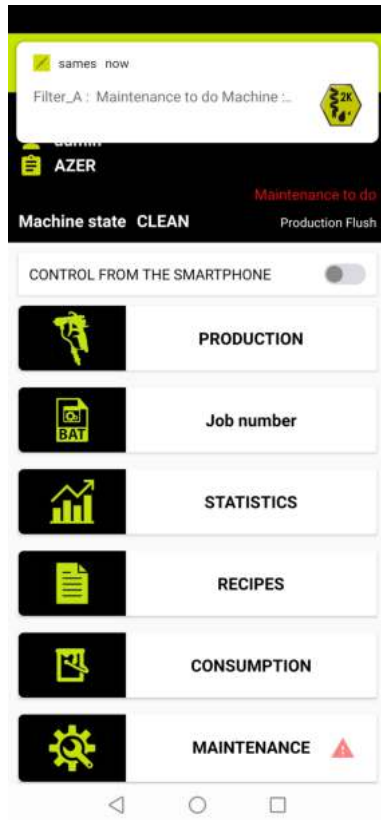

### 3. Technical features

#### 3.1. Technical features of the Cyclomix® Evo

<b>Type of machine</b>	2K, 3K & (1K)
<b>Type of paint</b>	Water or solvent based, acid catalyst, PU, Epoxy
<b>Number of product A</b>	99
<b>Number of product B</b>	99
<b>Number of product C</b>	99
<b>Number of recipes</b>	250
<b>Ratio</b>	100:1 to 1:2 (1% to 200%)
<b>Flow rate</b>	30cc to 7000cc
<b>Maximum pressure</b>	240b
<b>Viscosity</b>	20 - 3,000 mPas, (depending on flow meter)
<b>Number of circuit</b>	Up to 2
<b>Number of quick-drain valves</b>	Up to 2
<b>Smartphone application</b>	Android, IOS
<b>Communication 4.0</b>	OPCua
<b>Commande déportée</b>	Touch screen or magnetic control
<b>Remote control</b>	Ethernet, Modbus, Profinet, CC-link
<b>Management of users</b>	Operator / maintenance / distributor
<b>Manufacturing order number</b>	12 digits
<b>Management of data</b>	Excel file, OPCua

3.2. Dimensions (cm)

3.2.1. Dimensions Cyclomix® Evo

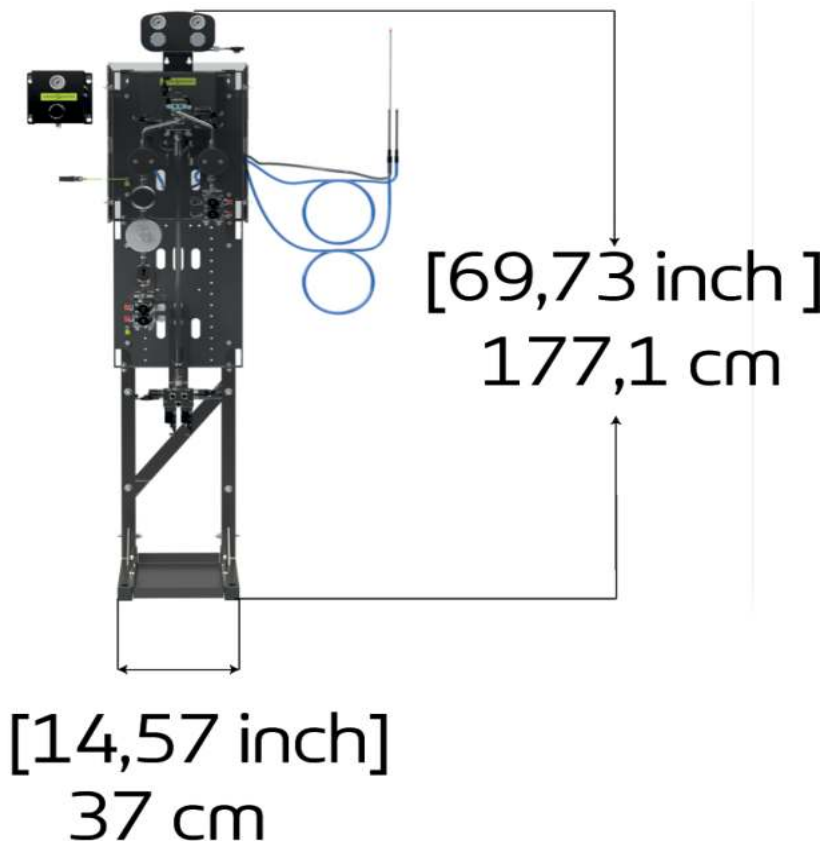



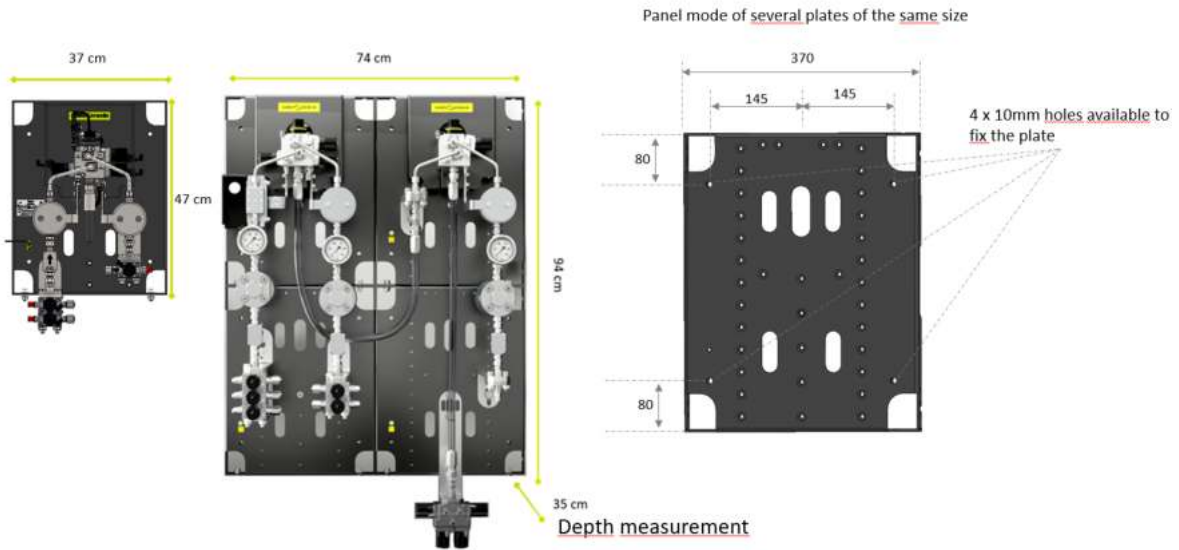

3.2.2. Main box dimensions

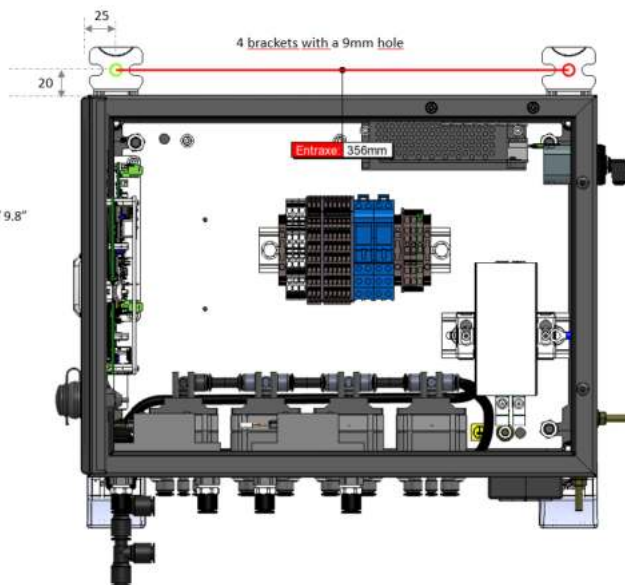
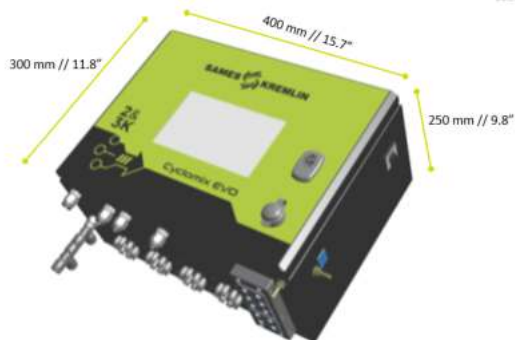
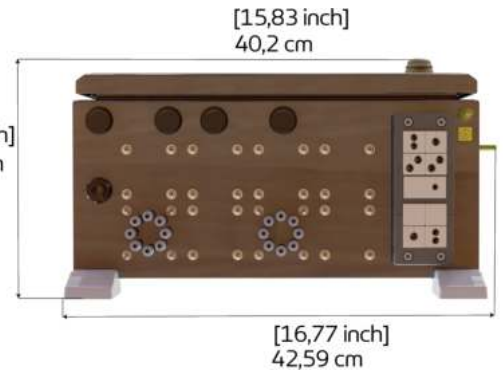
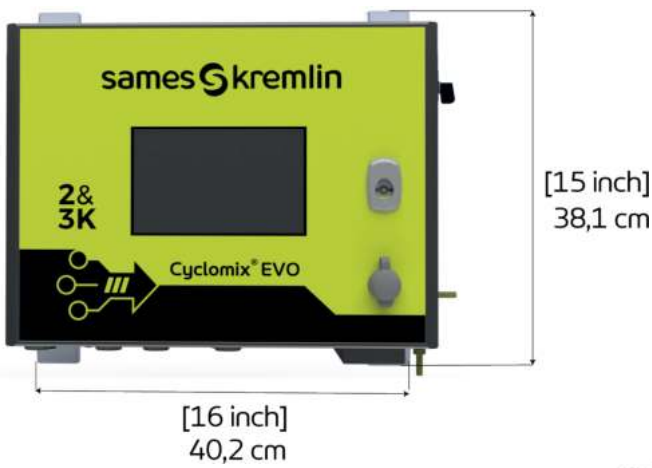

3.2.3. Additional box Evo+ dimensions

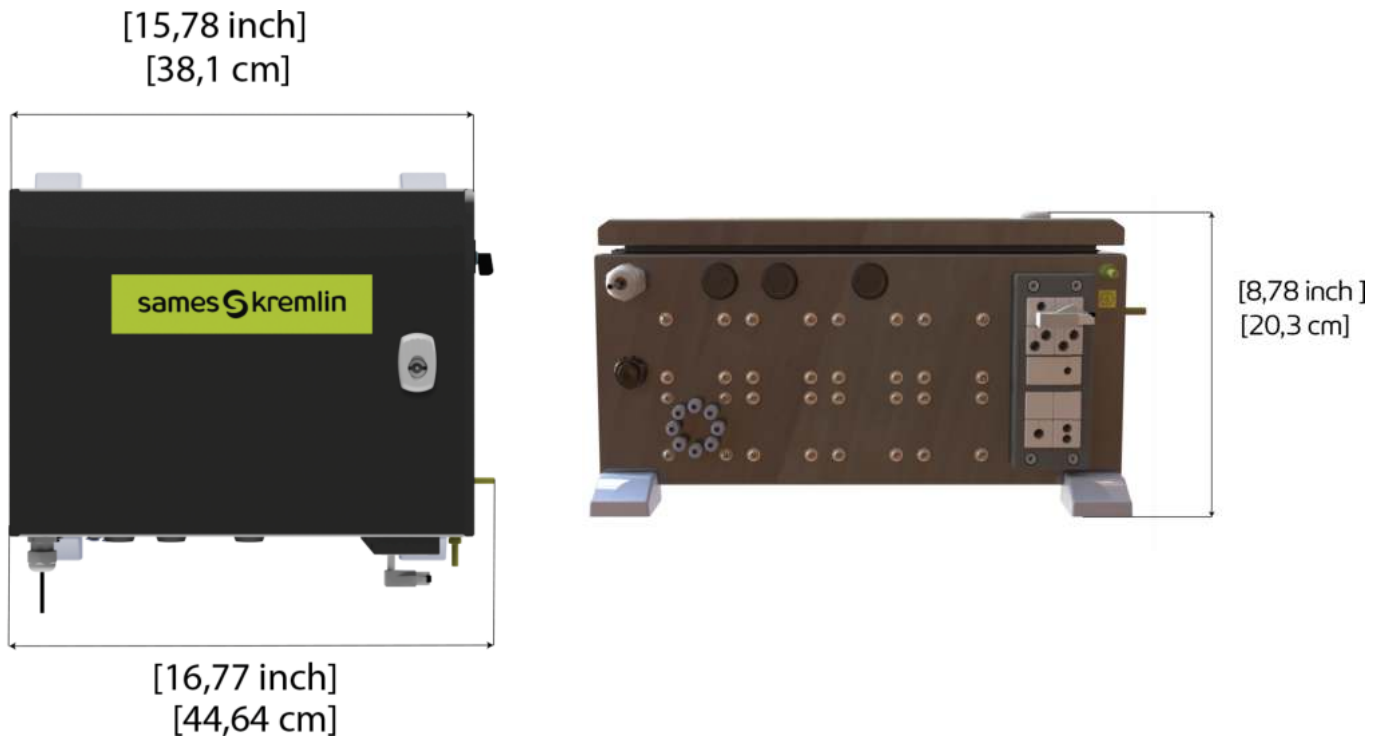

3.2.4. Remote box dimensions

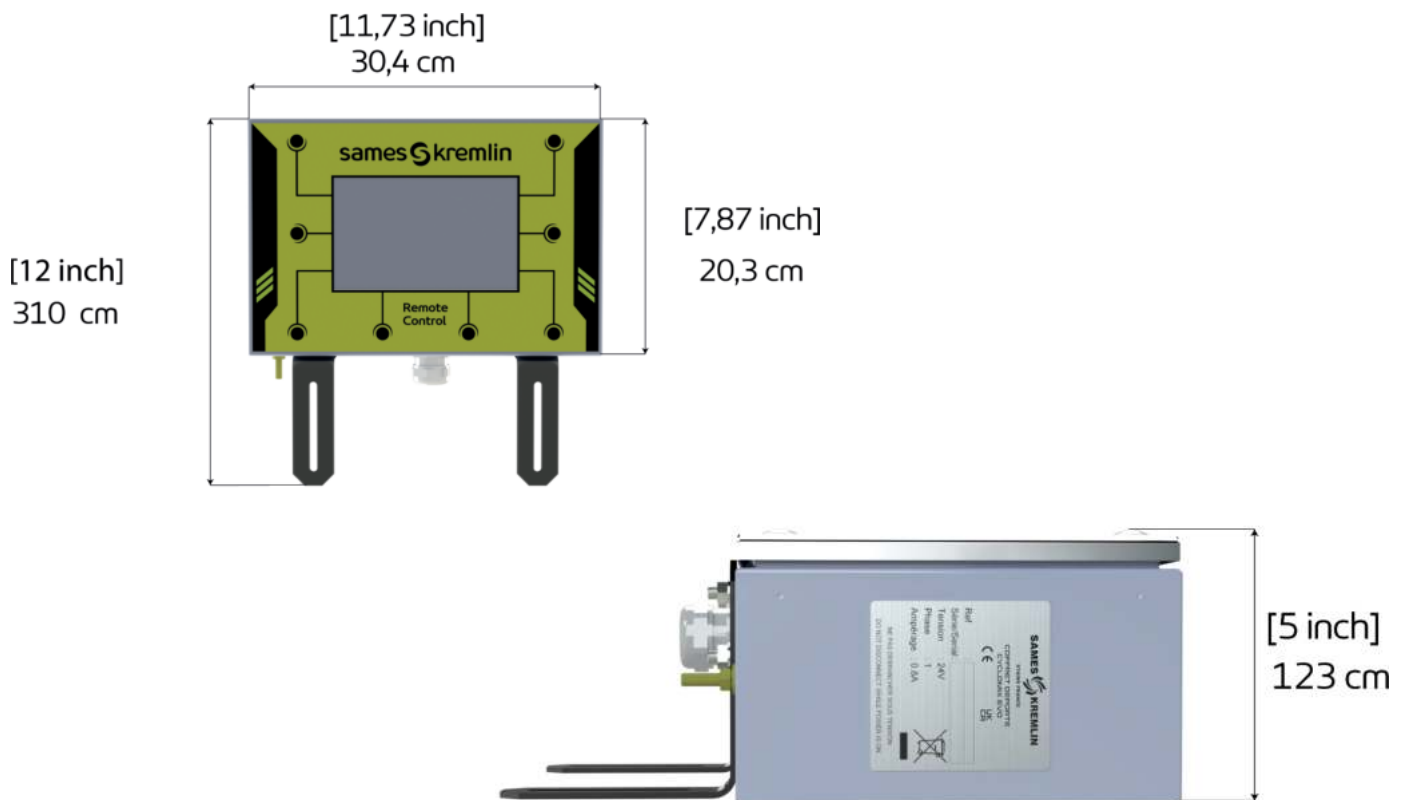

3.2.5. Cutout for the cabin assembly: Cyclomix<sup>®</sup> Evo remote box

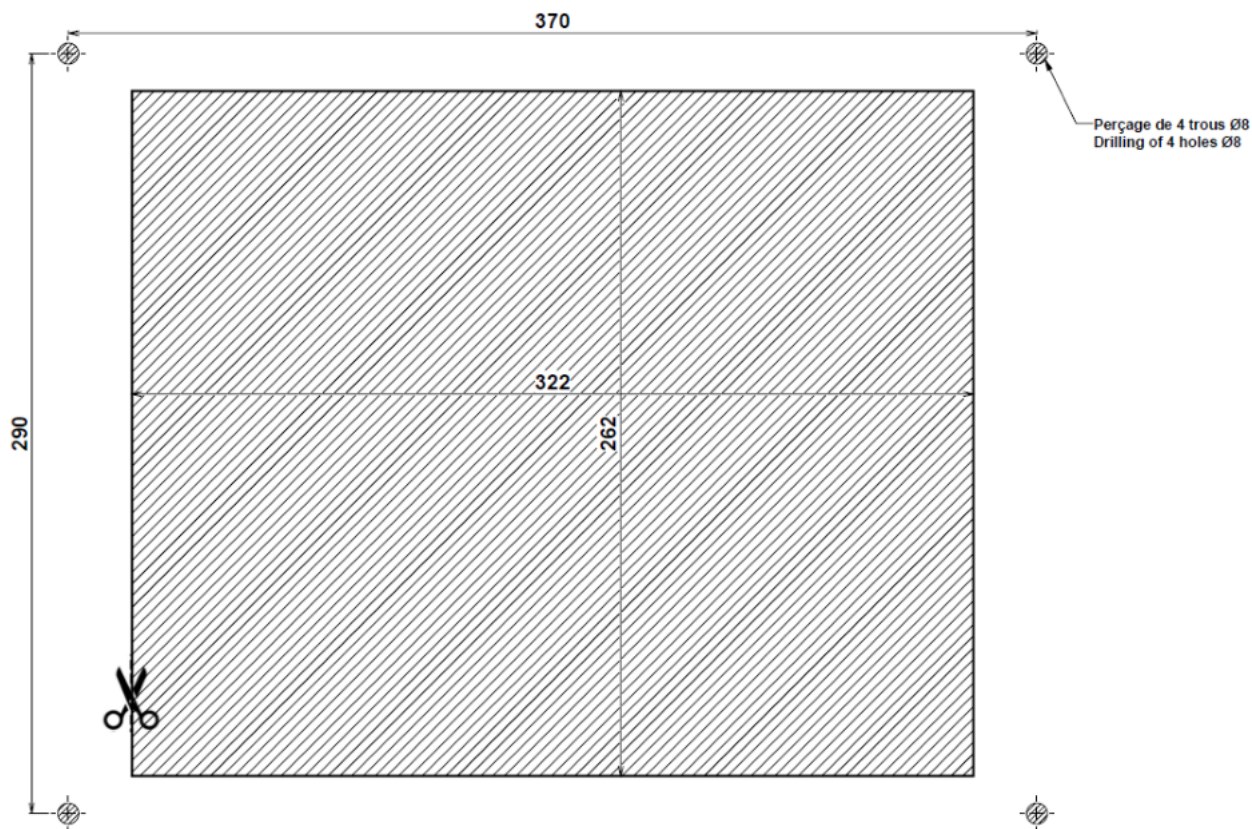

Découpe pour l'ensemble cabine => coffret déporté CYCLO EVO  
Cutout for the cabin assembly => CYCLO EVO remote box

Echelle 1:1  
Scale 1:1

### 3.3. Operating principle

#### 3.3.1. File and communicate in network mode

##### Introduction

This section contains the information necessary to easily use the optional communication module to display and control the Cyclomix<sup>®</sup> Evo via a network link.

##### Description

In auto mode (network), a PLC manages the display of data and/or the control of data from the Cyclomix<sup>®</sup> Evo. It communicates with the Cyclomix<sup>®</sup> Evo using the network communication module added on the CPU (CCB).

This **SAMES** specific communication module exists in different protocols: Ethernet IP, Profinet, Modbus, CC-Link.

##### Installation

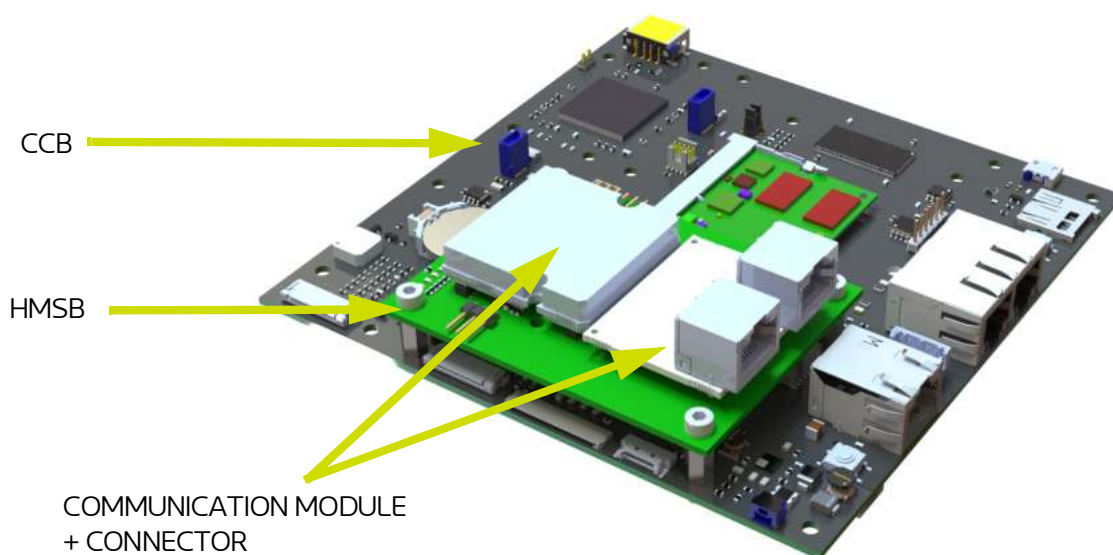

**Installation of the DIOB TOR**

This board should be installed on last position on the EtherCAT network of the machine.

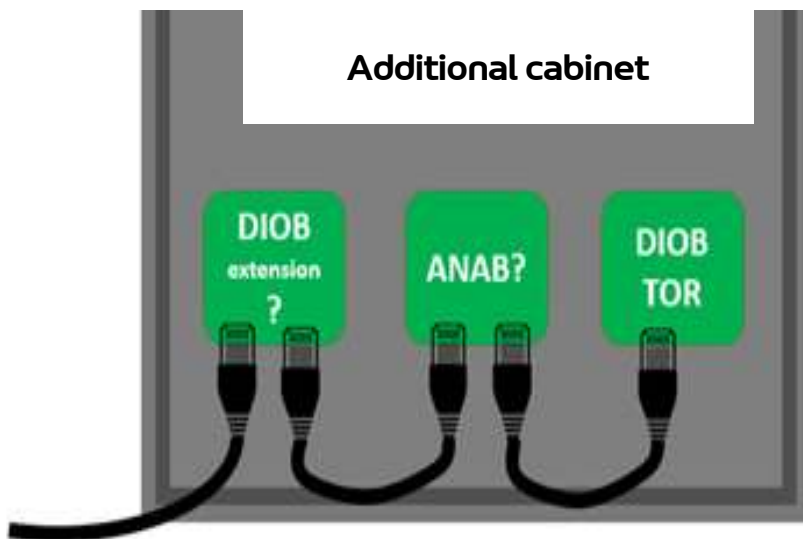

To use the DIOB as a communication board make sure that the switches of the board are set to the right value : with only switch 2 set to ON.

Scan the bus on page 14 of the maintenance menu. You should see the board as "ROBOT Dig. I/O". If so, you can now download this new configuration and start the bus.

**Synoptic**

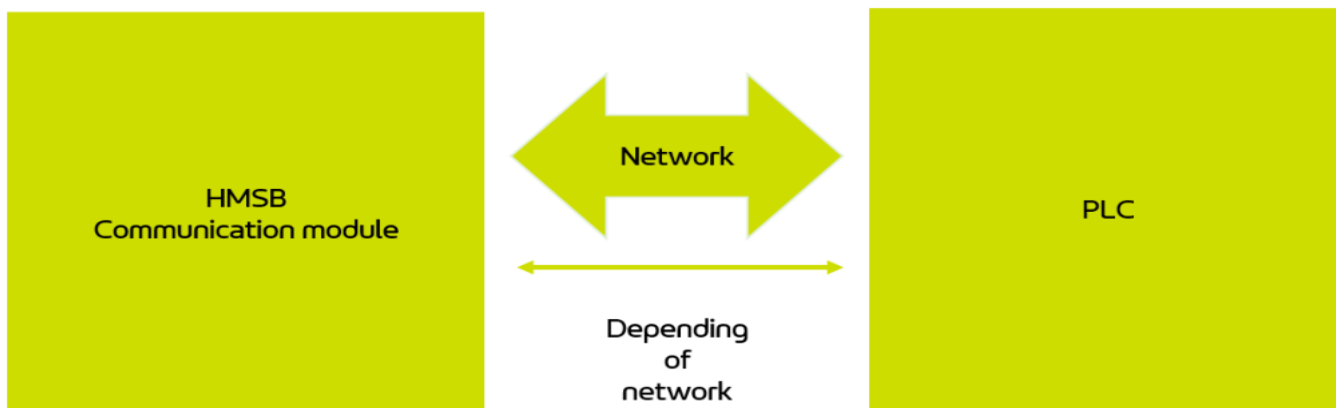

Features

IP Ethernet Module

Front view of the RJ45 module

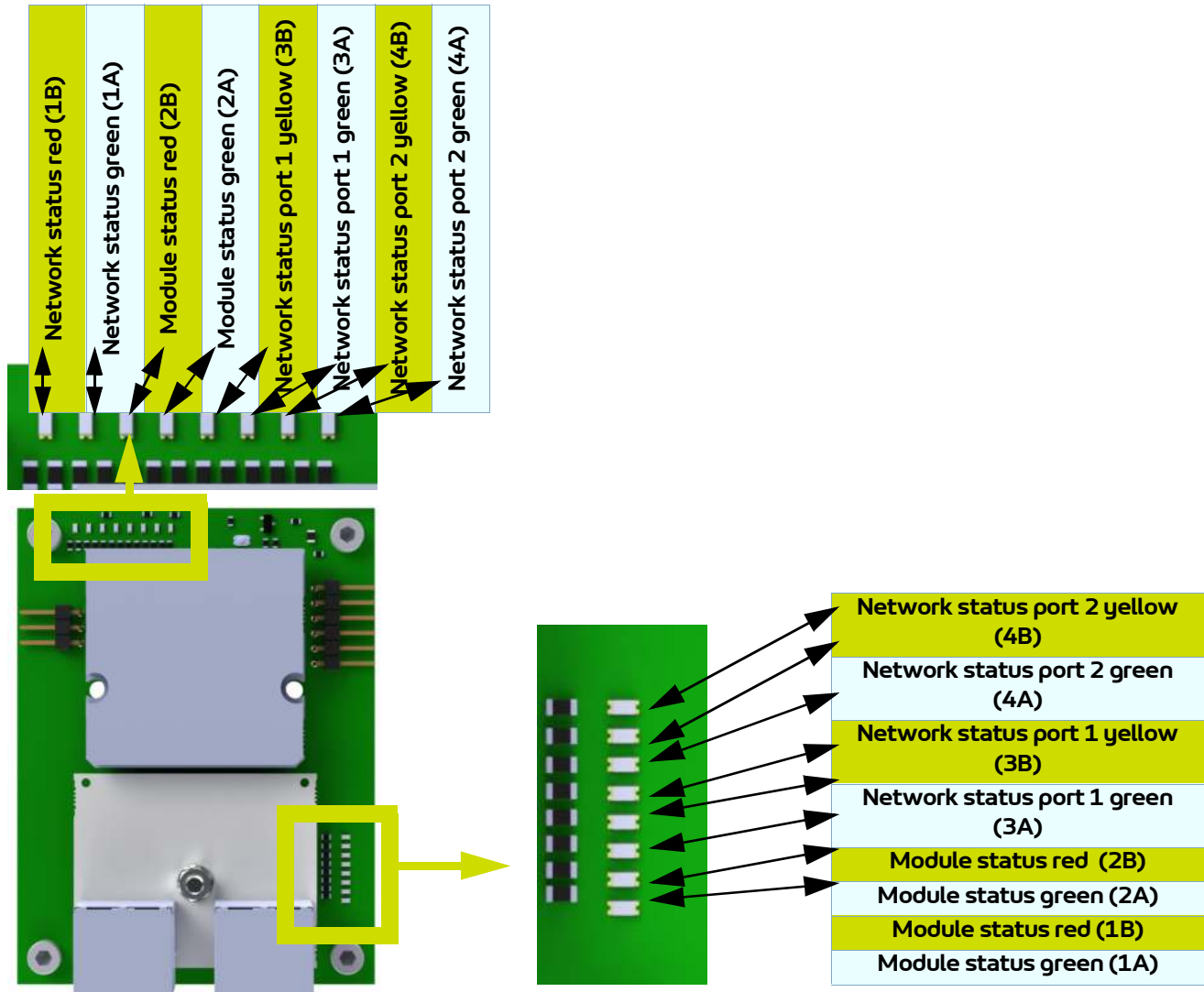

The Ethernet cable can be connected to both ports.

Ethernet IP LED

Network status LED

LED status	Description
Off	No power or no IP address
Green	Online, one or more connections established (CIP Class 1 or 3)
Green, flashing	Online, no connections established.
Red	Duplicate IP address, fatal error.
Red, flashing	One or more connections timed out (CIP class 1 or 3).



### LINK/Activity LED 3/4

LED status	Description
Off	No link, no activity
Green	Link (100 Mbit/s) established
Green, flickering	Activity (100 Mbit/s)
Yellow	Link (10 Mbit/s) established
Yellow, flickering	Activity (10 Mbit/s)

### Module status LED

LED status	Description
Off	No power
Green	Controlled by a Scanner in Run state and, if CIP Sync is enabled, time is synchronized with a Grandmaster clock.
Green, flashing	Not configured, Scanner in Idle state, or, if CIP Sync is enabled, time is synchronized with the Grandmaster clock.
Red	Major fault (EXCEPTION-state, FATAL error, etc.)
Red, flashing	Recoverable Fault(s). The module is configured, but stored parameters differ from currently used parameters.

### Ethernet IP setting

For Ethernet IP, it is necessary to set an IP address and a subnet mask.

The IP address must be in the same range as the IP address of the PLC system.

Those parameters can be set through page 17 of the Configuration menu on the Cyclomix<sup>®</sup> Evo screen.

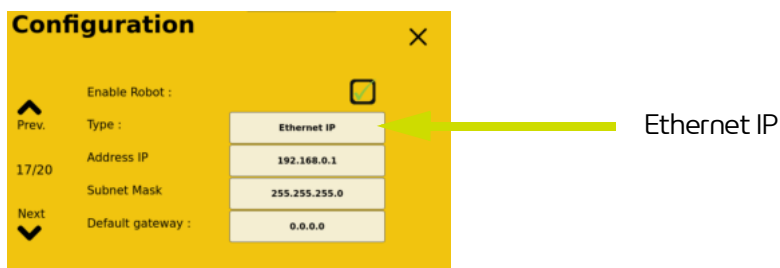

For EtherNet IP, the characteristics of a device are stored in an ASCII data file with the suffix EDS. This file is used by the PLC configuration tools when setting up the network configuration, (with instance ID for PLC input =100, and instance ID for PLC output =150).



This configuration file can be downloaded from [www.sames.com](http://www.sames.com)

Profinet module  
**Front view of the RJ45 module**

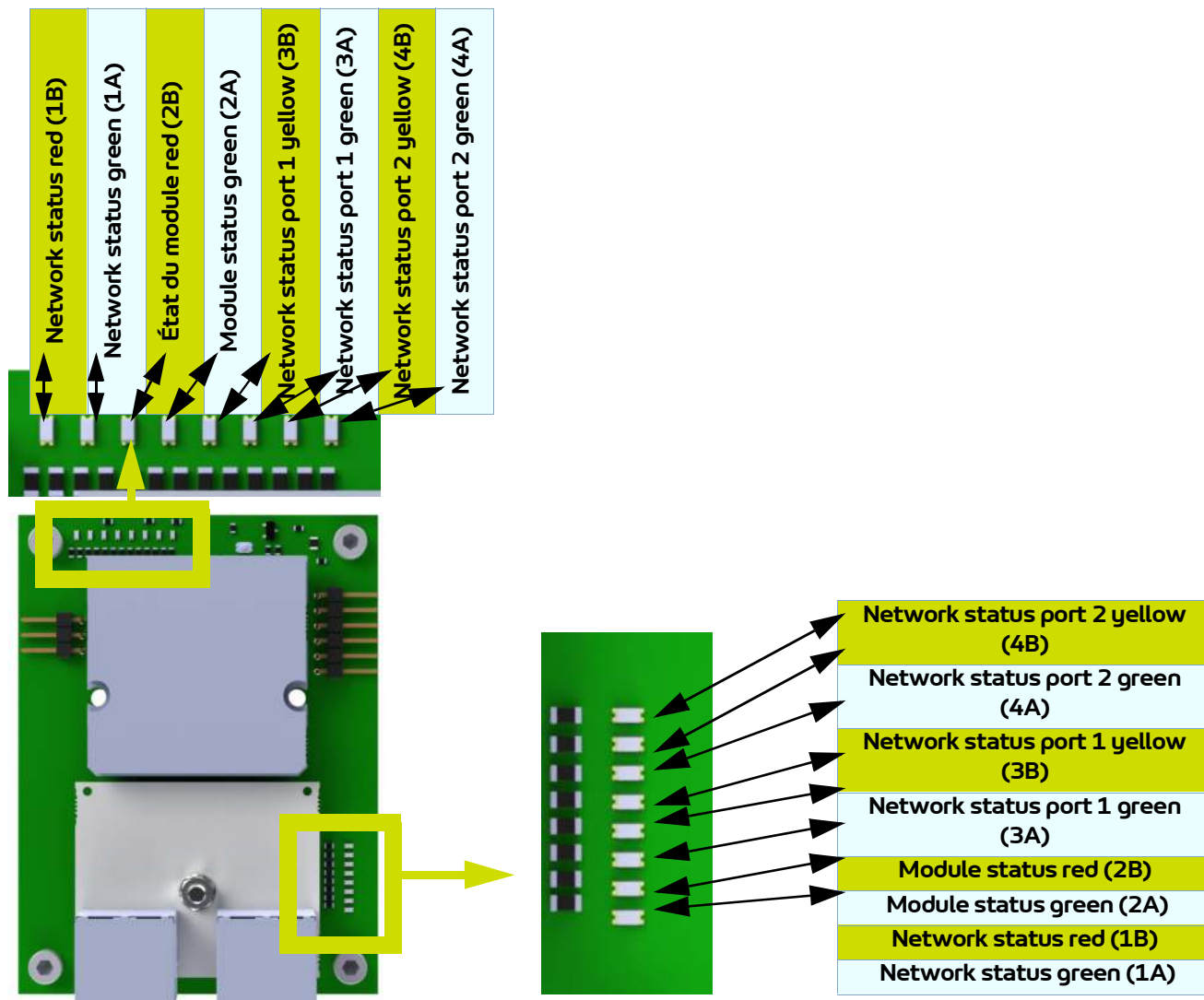

The Ethernet cable can be connected to both ports.



### LED network status

LED status	Description	Comments
Off	Offline	<ul style="list-style-type: none"> <li>No power</li> <li>No connection to the I/O controller</li> </ul>
Green	Online (RUN)	<ul style="list-style-type: none"> <li>Connection with the I/O controller established</li> <li>Input/Output controller in RUN state</li> </ul>
Green, 1 flash	Online (STOP)	<ul style="list-style-type: none"> <li>Connection with the I/O controller established</li> <li>The I/O controller in STOP state or I/O data bad.</li> <li>IRT* synchronization not finished.</li> </ul> *Isochronous Real Time / Temps Réel Isochrone
Green, blinking	Blink	Used by engineering tools to identify the node on the network.
Red	Fatal event	Major internal error (this indication is combined with a red module status LED)
Red, 1 flash	Station name error	Station name not set
Red, 2 flashes	IP address error	IP address not set
Red, 3 flashes	Configuration error	Expected identification differs from Real identification

### Module Status LED

LED status	Description	Comments
Off	Not initialized	No power supply OR Module in SETUP or NW_INIT state
Green	Normal operation	Module has shifted from the NW_INIT state.
Green, 1 flash	Diagnostic event(s)	Diagnostic event(s) present
Red	Exceptional error	Device in state EXCEPTION
	Fatal event	Major internal error (this indication is combined with a red network status LED)
Alternating red/grey	Firmware update	Do NOT power off the module. Turning down the module off during this phase could cause permanent damage.

### Link/activity LED

État LED	Description	Comments
Off	No link	No link, no communication present
Green	Link	Ethernet link established, no communication present.
Green, flickering	Activity	Ethernet link established, communication present.

### Profinet parameters

The module needs to be assigned a station name and an IP address in order to participate on PROFINET. These parameters can be set through page 17 of the Configuration menu on the Cyclomix<sup>®</sup> Evo screen.

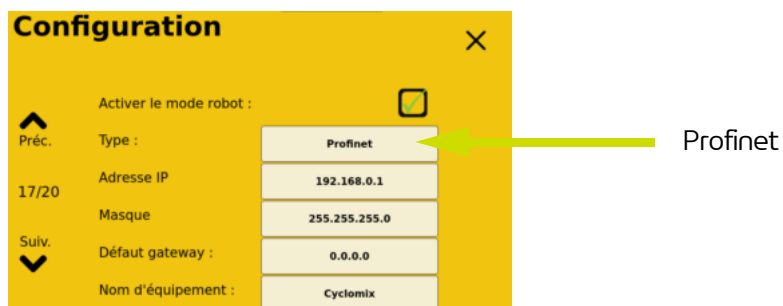

On PROFINET, the characteristics of a device are stored in an XML data file.

This file, referred to as the "GSD", is used by the PROFINET engineering tools when setting up the network configuration.



This configuration file can be downloaded from [www.sames.com](http://www.sames.com)

CC-link Module

Front view of the CC-link module

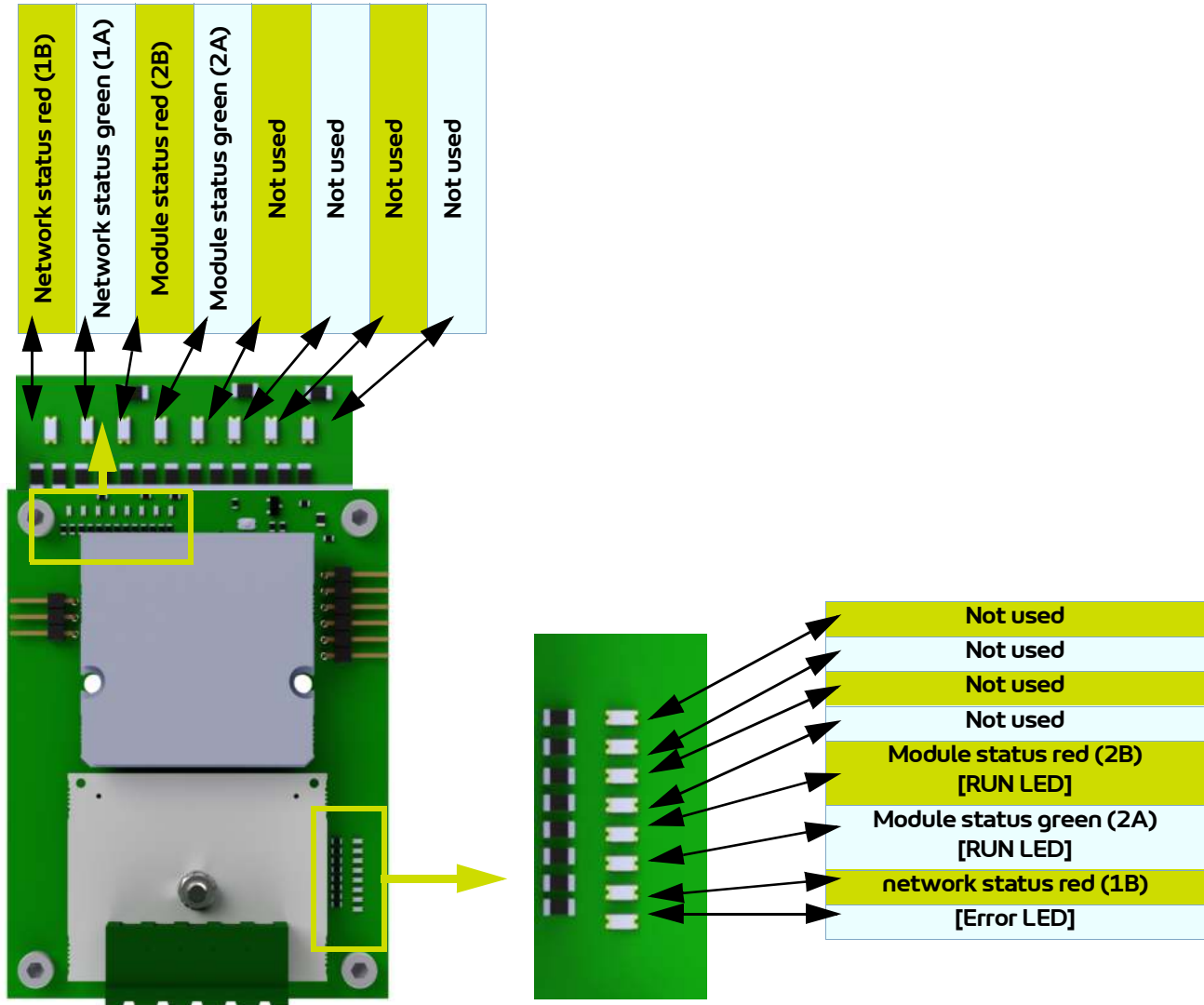

## LED CC-link

### Operating LED

LED status	Indication / Description
Off	No network participation, timeout status (no power)
Green	Participating, normal operation
Red	Major fault (FATAL error)

### Error LED

LED status	Description
Off	No error detected (no power)
Red	Major fault (Exception or FATAL event)
Red, flickering	CRC error (temporary flickering)
Red, flashing	Station number or baud rate has changed since startup (flashing)

### CC-Link connector

LED status	Description	Comments
1	DA	Positive RS485 RxD/TxD
2	DB	Negative RS485 RxD/TxD
3	DG	Signal Ground
4	SLD	Cable Shield
5	FG	Functional earth

### CC-Link setting

On CC-Link, each device on the network must be assigned a unique Station Number.

The highest possible Station Number depends on the number of occupied stations.

Three stations are occupied by the communication module.

CC-Link Version 2 is used with 4 extension cycles to have larger data size (320 bits and 48 words).

Only words are used for process data, but the last 16 bits of the bits area are used for exchanging flags (§ 4.1) in order to start the network.

- 156 kbps
- 625 kbps
- 2,5 Mbps
- 5 Mbps
- 10 Mbps

The baud rate and station number can be defined through page 17 of the Configuration menu of Cyclomix<sup>®</sup> Evo screen.



Each CC-Link device is associated with a CC-Link family system profile (CSP+ file), which contains a description of the device and its functions.



This configuration file can be downloaded from [www.sames.com](http://www.sames.com)

Modbus module

Front view of the RJ45 module

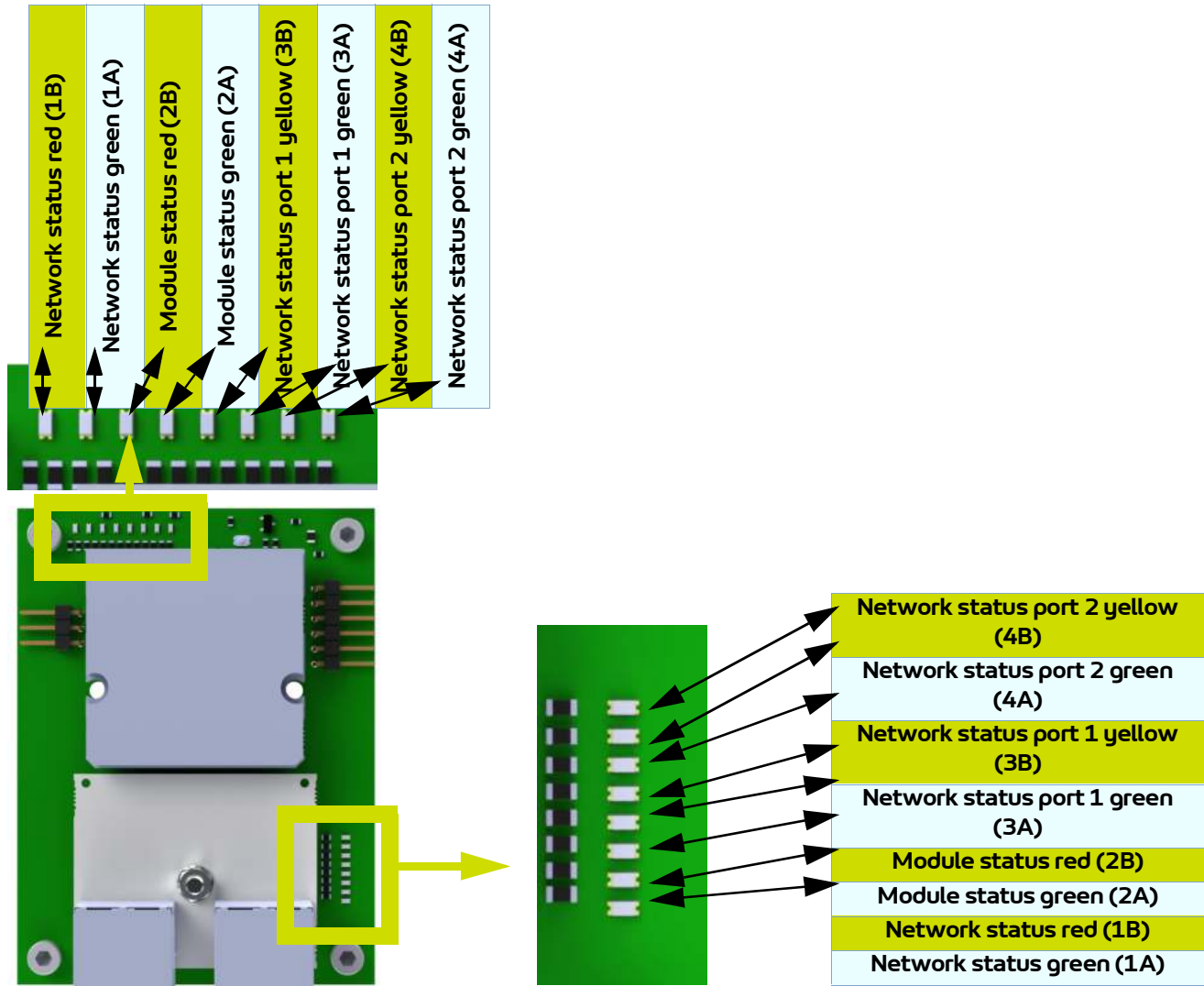

The Ethernet cable can be connected to both ports.

Modbus LED

Network status LED

LED status	Description
Off	No IP address or in state EXCEPTION
Green	At least one MODBUS message received
Green, flashing	Waiting for first Modbus message
Red	IP address conflict detected, FATAL ERROR
Red, flashing	Connection timeout. No Modbus has been received within the configured «Process active timeout» time.

**Module status LED**

LED status	Description
Off	No power
Green	Normal operation
Red	Major fault (including Anybus exception), FATAL
Red, flashing	Minor fault
Alternating red/green	Firmware update from the current file system in progress.

**LINK/Activity LED 3/4**

LED status	Description
Off	No link, no activity
Green	Link (100 Mbit/s) established
Green, flickering	Activity (100 Mbit/s)
Yellow	Link (10 Mbit/s) established
Yellow, flickering	Activity (10 Mbit/s)

**Modbus settings**

For Ethernet IP, it is necessary to fix an IP address and a subnet mask. The IP address should be in the same range as the IP address for the PLC system.

Those parameters can be set through page 17 of the Configuration menu of the Cyclomix® Evo screen.

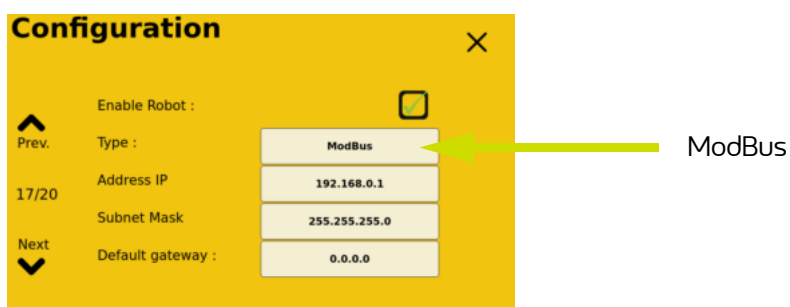

**ROBOT Digital IO with DIOB\***

When ticking the box, if no error message appears your machine is then ready to communicate with a robot/PLC through the DIOB TOR board and the main DIOB (in the main cabinet).

\* only from version 1.8.0-RC



**Data exchange**

**Exchanging data flags for CC-Link only.**

The location of the system area is at the very end of the bit area. 16 bits are reserved for this use.

Bit	Description	Description	Bit	
15	(Reserved)		15	(Reserved)
14			14	
13			13	
12			12	
11	Remote ready	Normal operation if high (for initial setting, at the rising edge of the PLC «Initial Data Processing complete» Flag, in runtime if there is no «Error Status» nor 'Error reset request» nor «Initial Data Setting Request»).	11	(Reserved)
10	Error Status	Diagnostic event exist - this flag stays high until the PLC has acknowledged the event through the «Error Reset Request».	10	Error Reset Request
9	Initial Data Setting Complete	The master PLC asks for an «Initial Data Setting Request».	9	Initial Data Setting Request
8	Initial Data Processing Request	Le Cyclomix® Evo asks for an «Initial Data Processing Request».	8	Initial Data Processing Complete
7	(Reserved)		7	(Reserved)
6			6	
5			5	
4			4	
3			3	
2			2	
1			1	
0			0	



**Before exchanging process data (at each communication start), the PLC must answer to the "Initial Data Processing Request" by setting the "Initial Data Processing Complete" to 1 in order the communication module of the Cyclomix® Evo switches in Remote READY state.**

**The Cyclomix® Evo module takes then into account the process data from the PLC. The Cyclomix® Evo module takes then into account the process data from the PLC.**



### From the PLC to the Cyclomix® Evo module

2 words are exchanged from PLC to the Cyclomix® Evo.

	Label	Parameter description
0	PLC_Command_1	Commands requested by the PLC (see description hereafter)
1	PLC_Command_2	Commands requested by the PLC (see description hereafter)

	PLC_Command_1	Détail de la commande PLC mot 0 en bit
15		
12		
13		
11		
10		
9		
8		
7		
6		
5	Push color gun 2	Set the bit to "1" to start paint optimization on gun 2 (hold).
4	Push color gun 1	Set the bit to "1" to start paint optimization on gun 1 (hold).
3	Gun 2 open	Set the bit to "1" to indicate that gun 1 is open (hold).
2	Gun 1 open	Set the bit to "1" to indicate that gun 1 is open (hold)..
1	Gun 2 in use	Set the bit to "1" to use the gun in production.
0	Gun 1 in use	Set the bit to "1" to use the gun in production.

	PLC_Command_2	Detail of PLC command word 1 in bit
15	Reset consumption	Set the bit to "1" to clear the consumption of the active recipe.
14	Reset alarm	Set the bit to "1" to clear the active errors.
13		
12		
11	Machine flush	Set the bit to "1" to do a machine flush (hold).
10		
9		
8	Production flush	Set the bit to "1" to do a production flush (hold).
7	Start production	Set the bit to "1" to start a production (hold).
6	Change color	Set the bit to "1" to start a change of color (hold).
5	Recipe number	Number of the recipe * (recipe index) to launch in production.
4		
3		
2		
1		
0		



**\*\*Recipe number: when editing recipe, check your recipe number as it can change when adding or deleting recipes.**

## From the Cyclomix® Evo module to the PLC

25 words are exchanged from Cyclomix® Evo to PLC.

	Label	Parameter description	Unit
0	Flag_1	Status information 1 (see description hereafter)	-
1	Flag_2	Status information 2 (see description hereafter)	-
2	Machine state	11 = Stop production, 12 = Prime ongoing, 13 = Production, 14 = Production flush ongoing, 15 = Machine flush ongoing, 16 = Regeneration ongoing, 17 = Production flush, 18 = Machine flush, 10 = Unknown state	-
3	Production flow	Current production flow	cc* 10/min
4	Ratio A/B	Current A/B ratio	ratio* 100
5	Ratio A/C	Current A/C ratio	ratio* 100
6	Current recipe	Actual recipe number on machine	-
7	Potlife gunt 1	Potlife of the mix on gun 1	sec
8			
9	Potlife gun 2	Potlife of the mix on gun 2	sec
10			
11	A consumption	Current A consumption.	cc
12			
13	B consumption	Current B consumption.	cc
14			
15	C consumption	Current C consumption.	cc
16			
17	Faults_1	Fault_1 information (see description hereafter)	-
18	Faults_2	Fault_2 information (see description hereafter)	-
19	A consumption saved	Last saved A consumption of the current recipe	
20			
21	B consumption saved	Last saved B consumption of the current recipe	
22			
23	C consumption saved	Last saved C consumption of the current recipe	
24			

0	Flag_1	Detail of status 1 information word 0 in bit
15	Machine flush ongoing	The Cyclomix® Evo is in machine flush
14	Potlife alarm gun 2	The Potlife time has been reached on gun 2
13	Potlife alarm gun 1	The Potlife time has been reached on gun 1
12	Error	Presence of a fault
11	Idle Potlife	The machine is in idle Potlife
10	Machine clean	The machine is clean
9		
8		
7		
6		
5		
4	Maintenance to do	Maintenance need to be done on a least one element.
3	In prime	the machine is in prime.
2	In auto mode	The machine is in auto mode, it is possible to control the machine via the network module.
1	In production	The machine is in production.
0	Color change	The machine is changing color.

1	Flag_2	Detail of status 2 information word 1 in bit
15		
14		
13		
12		
11		
10	No more paint available gun 2	
9	No more paint available gun 1	
8	Dump gun 2 in use *	
7	Dump gun 1 in use *V	
6	Paint Optimisation ongoing	
5	Flush production ongoing	
4	Warning Potlife gun 2	
3	Warning Potlife gun 1	
2	Gun 2 in use *	
1	Gun 1 in use *	
0	Regeneration ongoing	



\* During the prime when the robot should open its dump the bit Dump gun x in use and Gun x in use will be

set, when the robot should open its gun only the Gun x in use will be set.

15	Faults_1	Detail of fault 1 information word 17 in bit
15		
14		
13	Low flow alarm	The minimum flow rate has been reached
12	High flow alarm	The maximum flow rate has been reached
11		
10		
9		
8		
7		
6		
5		
4		
3		
2	Ratio deviation	The average ratio has been outside the limits.
1	Potlife alarm	To notify that Potlife time has expired on a gun
0	Communication error	There is an error in the protocole.

16	Faults_2	Detail of fault 2 information word 18 in bit
15	EtherCAT error	Error on the main network (EtherCAT)
14	Injection C leaking	The injection valve C is leaking : flow rate is not null while injection valve is closed.
13	Injection B leaking	The injection valve B is leaking : flow rate is not null while injection valve is closed.
12	Solvent C path not coherent	Flow rate sensor SC state is not coherent with gun's flow switch.
11	Path C leaking	Flow rate is not null while all the machine is in IDLE.
10	C path not coherent	Flow rate sensor C state is not coherent with gun's flow switch.
9	Flush step error	Flush step not correctly defined.
8	Flush step undefined for gun	There are no flush step defined for the requested gun.
7	Recipe error	Recipe is not complete in database : production components.
6	Solvent B path not coherent	The path SB is not coherent: flow rate sensor B state is not coherent with gun's flow switch.
5	Solvent A path not coherent	The path SA is not coherent: flow rate sensor A state is not coherent with gun's flow switch
4	Path B leaking	Flow rate is not null while all the machine is in IDLE.
3	Path A leaking	Flow rate is not null while all the machine is in IDLE.
2	Catalyser under pressure	Catalyser under pressure : when pressure of B is less than pressure of A.
1	B path not coherent	The path B is not coherent: flow rate sensor B state is not coherent with gun's flow switch.
0	A path not coherent	The path A is not coherent: flow rate sensor A state is not coherent with gun's flow switch.

Data mapping for Modbus only

Write/Read	Address	Description	Type	Size	Unité
R	30002	Machine state	unsigned word	16 bits	-
R	30003	Production flow	unsigned word	16 bits	cc * 10/min
R	30004	Ratio A/B	unsigned word	16 bits	ratio * 100
R	30005	Current recipe	unsigned word	16 bits	-
R	30006	Potlife 1	unsigned double word	32 bits	sec
R	30008	Potlife 2	unsigned double word	32 bits	sec
R	30010	Faults_1	unsigned word	16 bits	-
R	30012	Faults_2	unsigned word	16 bits	-
R	30013	Ratio A/C	unsigned word	16 bits	ratio * 100
R	30014	A consumption	unsigned double word	32 bits	cc
R	30016	B consumption	unsigned double word	32 bits	cc
R	30018	C consumption	unsigned double word	32 bits	cc
R	30020	A consumption saved	unsigned double word	32 bits	cc
R	30022	B consumption saved	unsigned double word	32 bits	cc
R	30024	C consumption saved	unsigned double word	32 bits	cc
W	40039	PLC_Command_1	unsigned word	16 bits	-
W	40040	PLC_Command_2	unsigned word	16 bits	-
R	30041	Flag_1	unsigned word	16 bits	-
R	30042	Flag_2	unsigned word	16 bits	-

Data mapping for TOR communication (through DIOB)  
**Inputs**

Board	IN	Name	Description
DIOB TOR	1	Program Code bit 0	The chosen recipe number (from 1 to 31).
	2	Program Code bit 1	
	2	Program Code bit 2	
	4	Program Code bit 3	
	5	Program Code bit 4	
	6	Prog validation	Setting this input (after setting the recipe and the gun(s) used) will launch the new recipe.
	7	Production flush	Setting this input will start a production flush.
	8	Machine flush	Setting this input will start a machine flush.
	9	Gun 1 use	Setting this input signals that gun 1 will be used in production.
	10	Gun 2 use	Setting this input signals that gun 2 will be used in production.
1 <sup>st</sup> DIOB	4	Gun 1 opened	Setting this input signals that the gun open.
	5	Gun 2 opened	This information can be send by a flow switch.
	6	Paint optimization gun 1	Setting this input starts paint optimization on a gun (needs to be configured beforehand).
	7	Paint optimization gun 2	
	8	Start production	Setting this input start the production.
	9	Reset alarm	Setting this input resets the current alarm.

## Outputs

Board	OUT	Name	Description
	1	Gun 1 in use	This output signals if the gun 1 is used by the current recipe.
	2	Gun 2 in use	This output signals if the gun 2 is used by the current recipe.
	2	Dump 1 in use	This output signals that the dump 1 is/should be opened.
	4	Dump 2 in use	This output signals that the dump 1 is/should be opened.
	5	No more paint gun 1	This output signals the end of paint optimization on gun 1.
	6	No more paint gun 2	This output signals the end of paint optimization on gun 2.
	7	Potlife gun 1	This output signals warning Potlife on gun 1.
	8	Potlife gun 2	This output signals warning Potlife on gun 2.
	9	Not use	
	10	Not use	
	11	Ongoing Program Code bit 0	Those outputs send the current recipe program code.
	12	Ongoing Program Code bit 1	
	13	Ongoing Program Code bit 2	
	14	Ongoing Program Code bit 3	
	15	Ongoing Program Code bit 4	
	16	Not use	
	17	Not use	
	18	Alarm	This output signals an alarm/error on the machine.
	19	Machine clean	This output signals that the machine is clean.
	20	Robot mode activated	This output signals that the machine is ready to communicate with a robot or PLC.
	21	Maintenance to do	This output signals that maintenance needs to be done.
	22	Not use	



Board	OUT	Name	Description
	23	Not use	
	24	Not use	
	25	Color change ongoing	This output signals that the machine is loading a new recipe.
	26	Prime ongoing	This output signals that the machine is priming a recipe.
	27	Production flush ongoing	This output signals that the machine is in production flush.
	28	Machine flush ongoing	This output signals that the machine is in machine flush.
	29	Regeneration ongoing	This output signals that the machine is regenerating the current recipe.
	30	Production ongoing	This output signals that production is ongoing.
	31	Paint optimization ongoing	This output signals that the paint optimization is ongoing.
	32	Idle Potlife	The machine is in idle, ready to produce.

## 4. Schematics

### 4.1. Fluid schematics

Not applicable.

### 4.2. Electrical schematic

#### 4.2.1. Main box

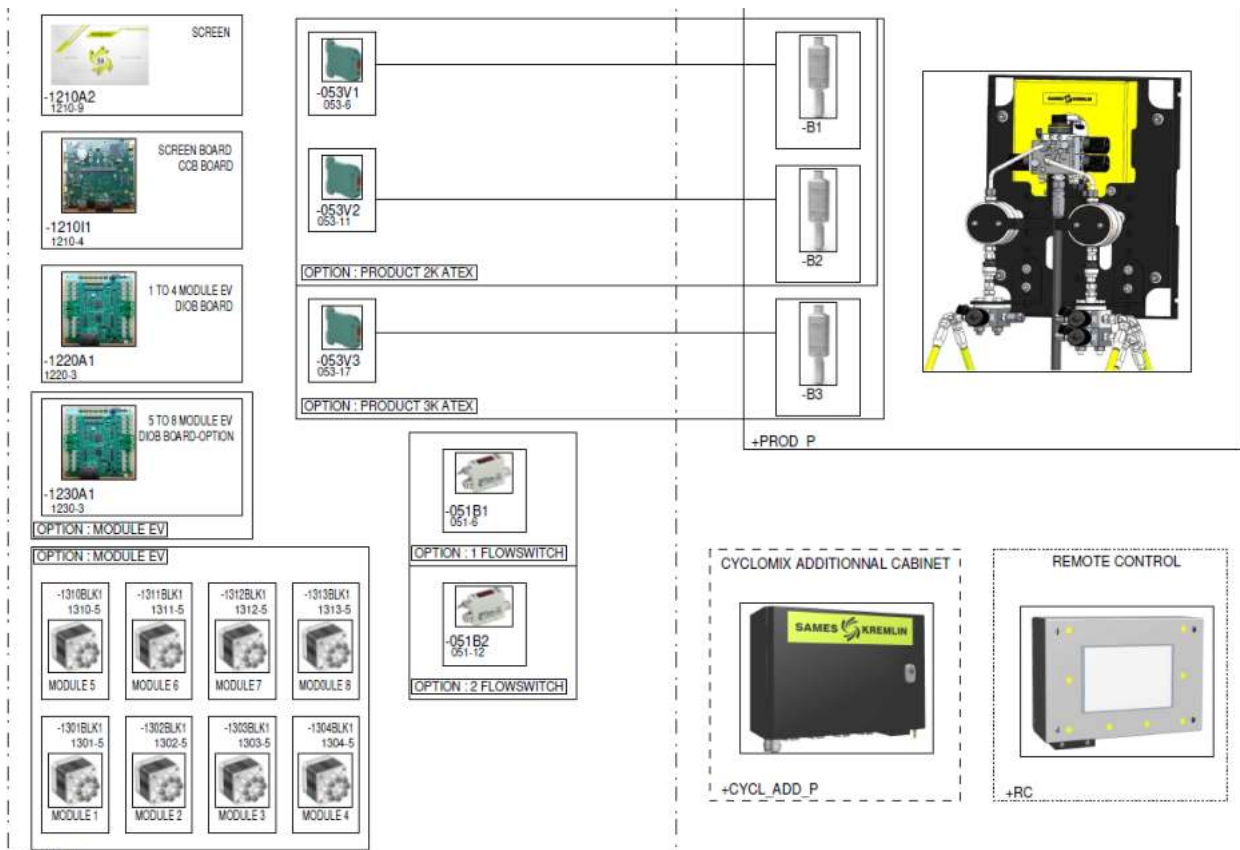
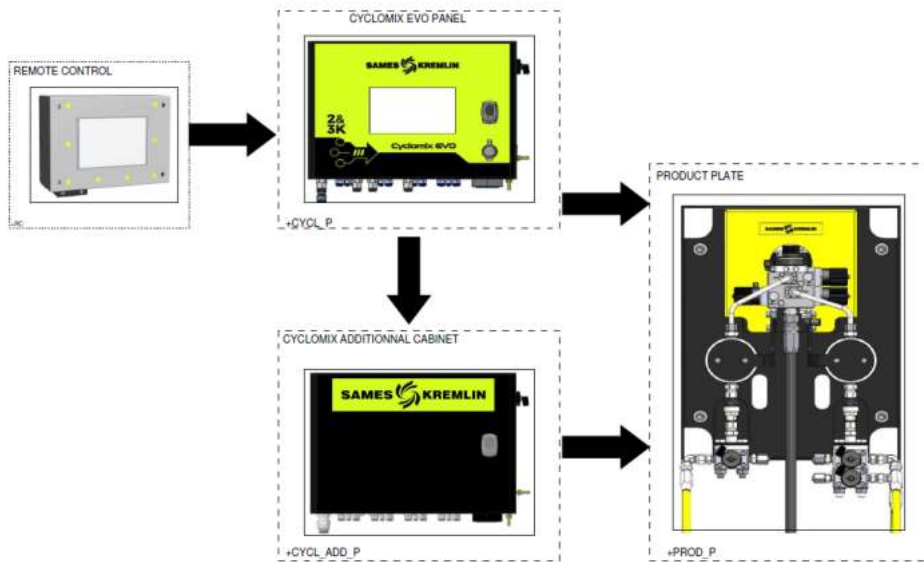



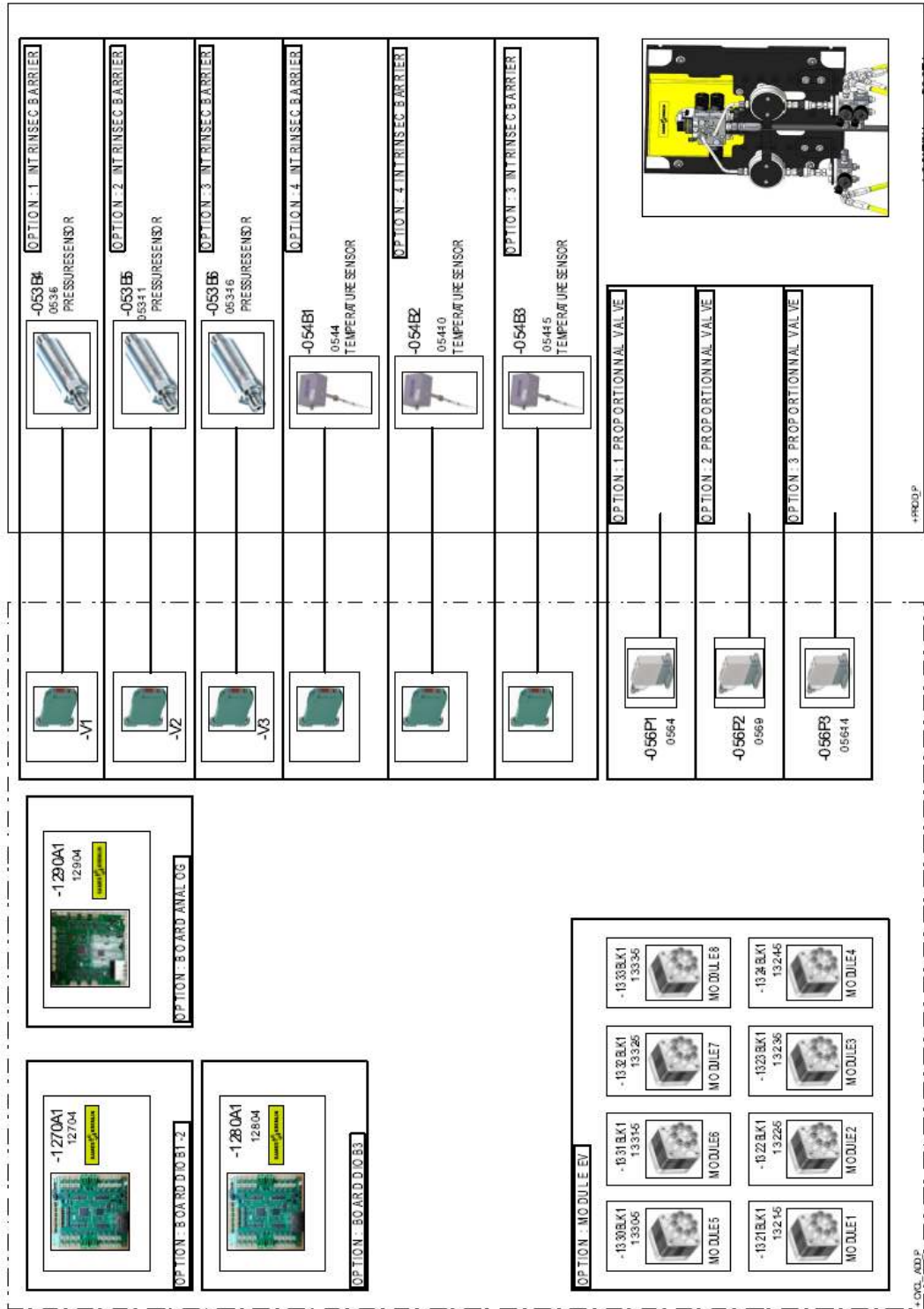

4.3.2. Network overview

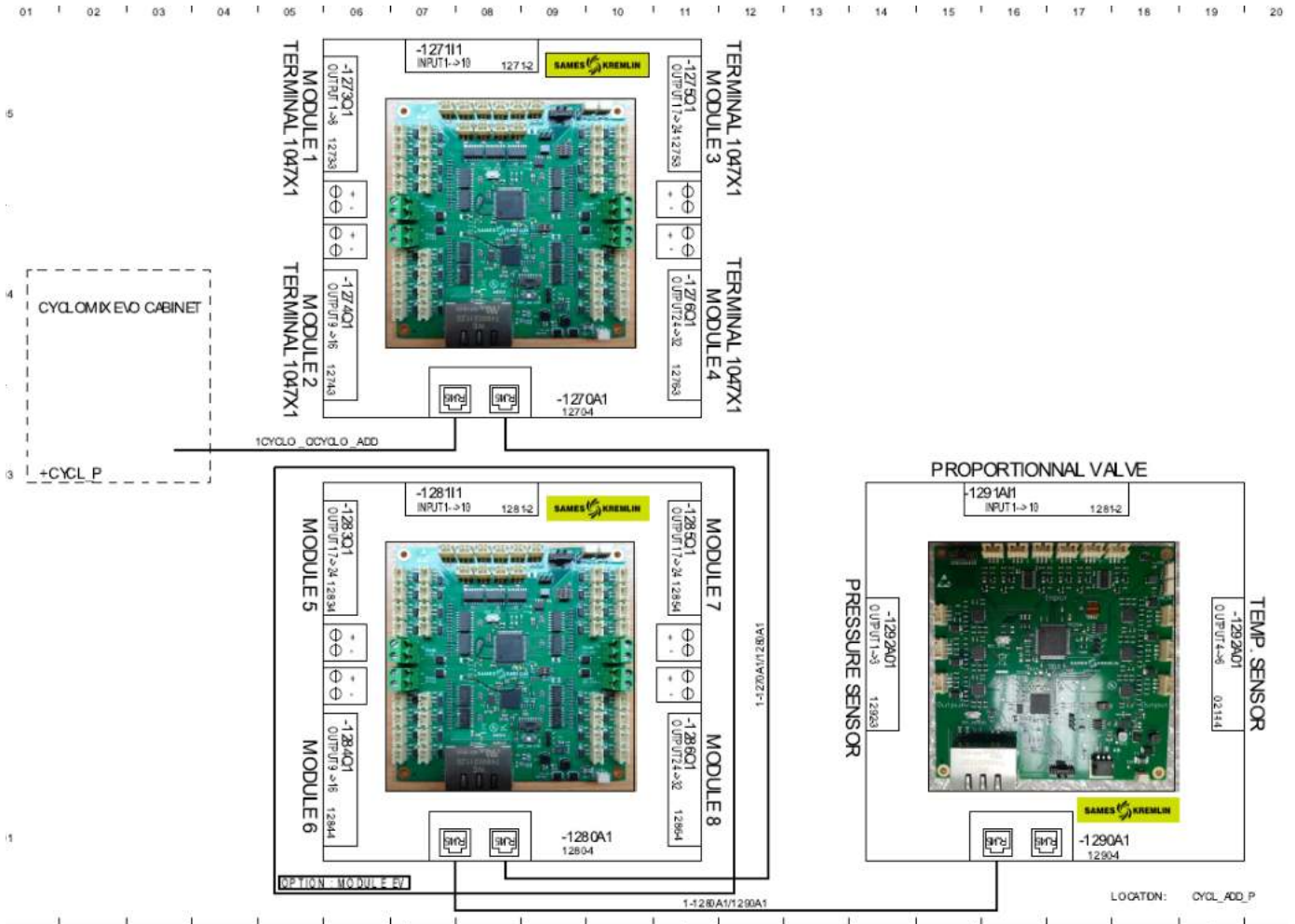



4.4. Remote box

4.4.1. Implantation

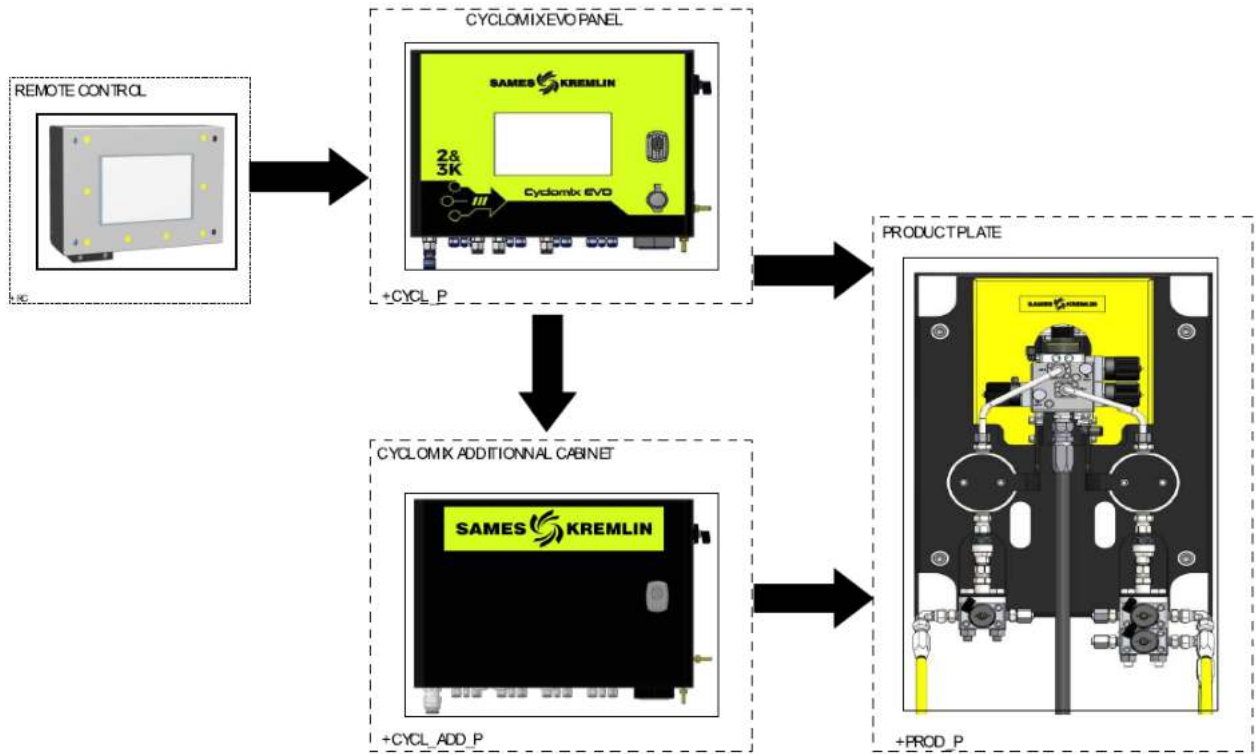

4.4.2. Network overview

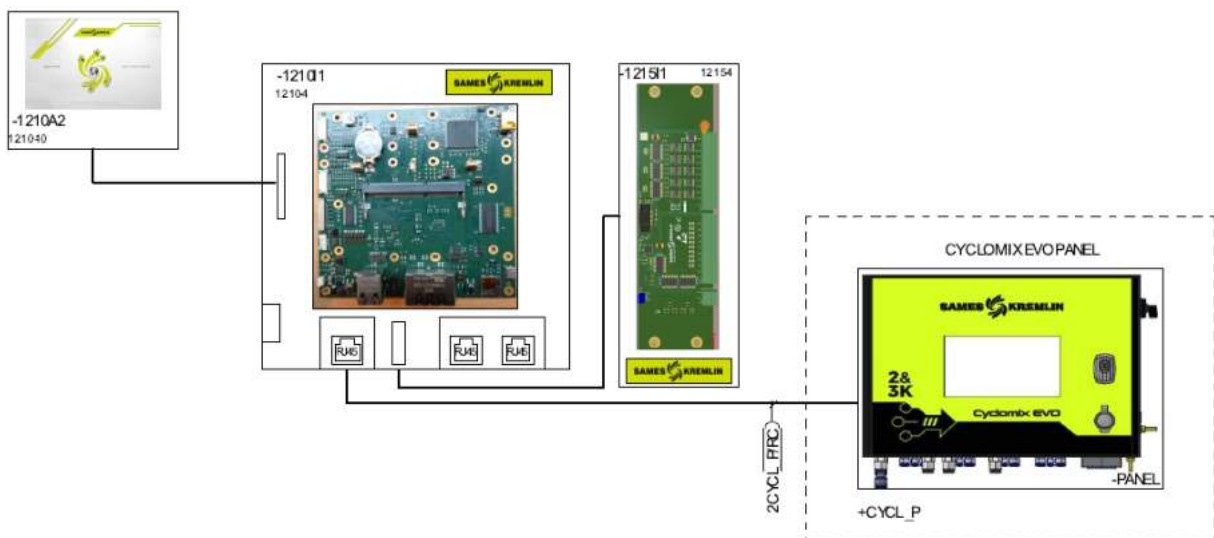

### 4.4.3. Installation of boxes

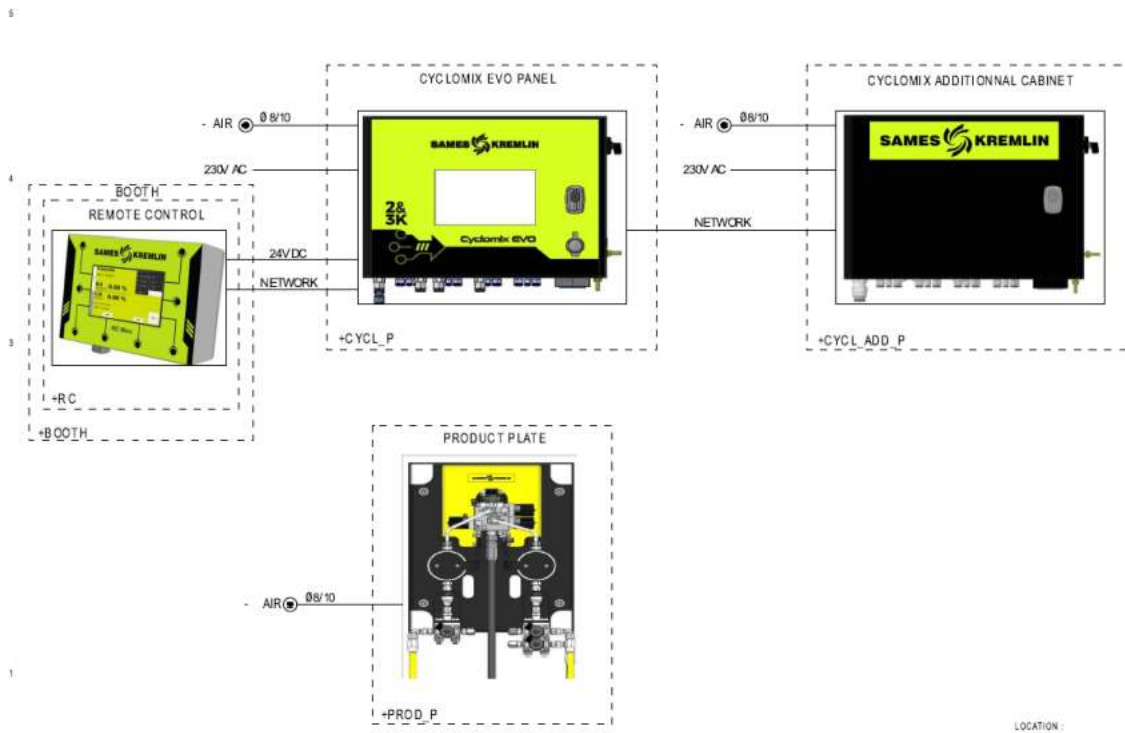

## 5. Start-up

### 5.1. Tools

Tools and accessories required:

The tools listed below are recommended for installation and maintenance of the equipment.

- A cross-headed screwdriver.
- A flat screwdriver (small, medium, large).
- A 17 mm flat wrench.
- An Allen key (2,5 mm; 4 mm; 5 mm; 10 mm).
- An O-ring hook.



## 5.2. Installation

Note: The equipments are tested in air and water to check the correct operation and the tightness of all components.

For installation rules: [see § 1.5.1 page 20](#)

### 5.2.1. Configuration of the product part in and out of the cabin

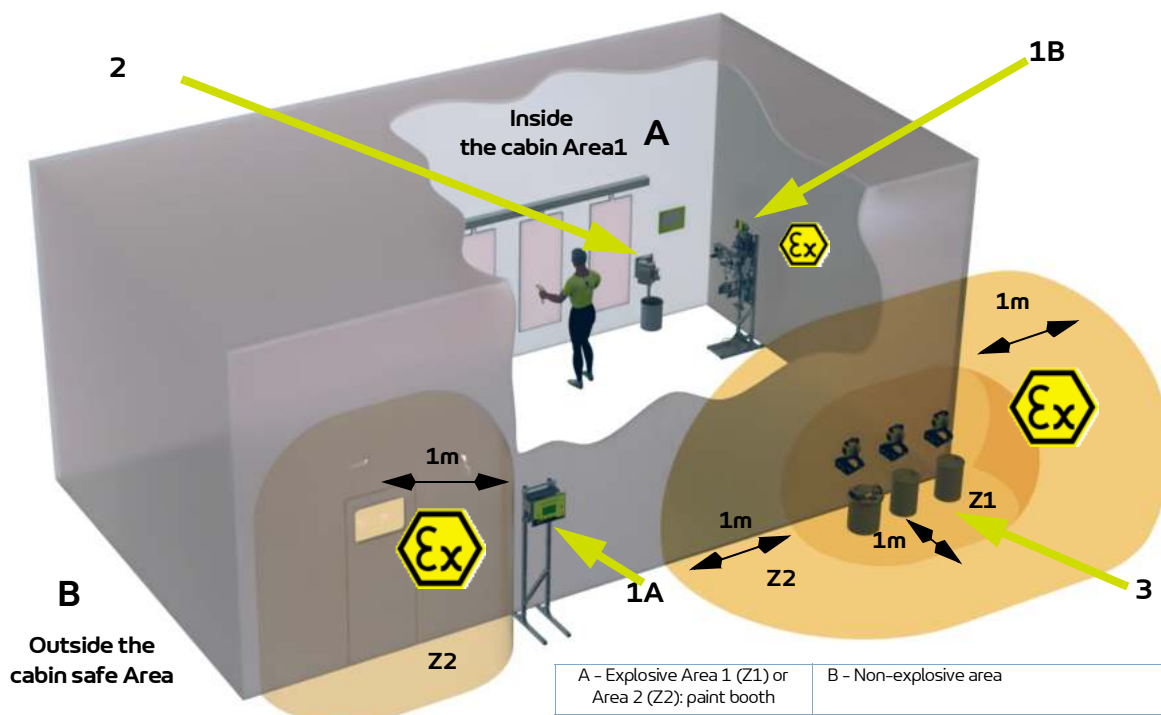

Item	Description
1A	Control panel
1B	Product plate
2	Flush box
3	Pumps + Accessories



The 1 m / 39.37" distance indicated in this diagram is given as for information purposes only and hold harmless to **Sames**.

The exact delimitation of the zones is the express responsibility of the user, depending on the materials used, the environment and the conditions of use.

The 1 m / 39.37" distance can be modified if the analysis conducted by the user requires it. (refer to standard EN 60079-10).

5.2.2. Install the feet when unpacking the Cyclomix<sup>®</sup> Evo with frame.



Refer to the foot mounting sheet provided with the equipment or the procedure below.

• **Step 1:**

In the received packing box:

- Identify the box (A) containing the Cyclomix<sup>®</sup> Evo frame.

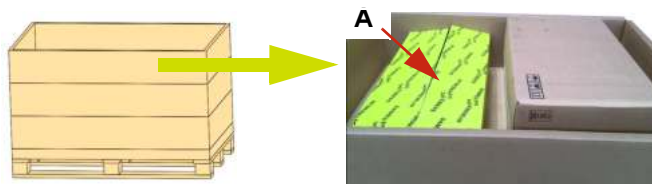

2 possible positions for the box containing the frame according to the Cyclomix<sup>®</sup> Evo configuration.

Position 1 = High extension.

Position 2 = Low extension.

Note: As the box is heavy, it is recommended that two people carry it.

It is advisable to empty it of its contents and to assemble the components gradually.



2 types of content depending on the cardboard containing the frame, with or without tray.



- **Step 2:**  
On the Cyclomix® Evo (horizontal position), visual A opposite, insert and slide to the stop the components of the foot as shown in visual B opposite.

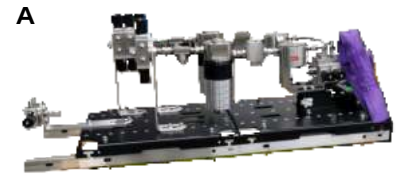

- **Step 3:**  
Take from the bag: screws and nuts. Fix by screwing and tightening the interlocking elements of the foot.

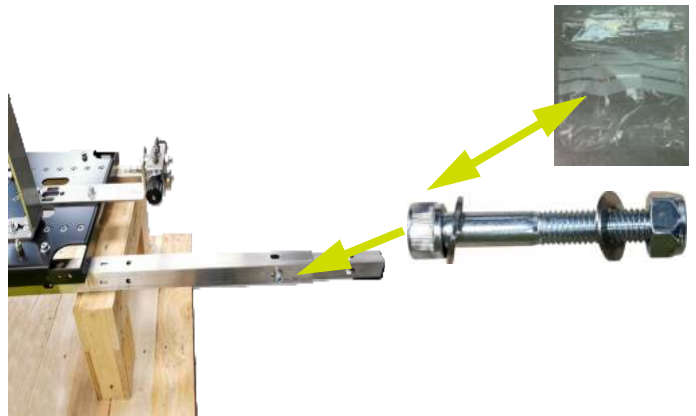

- **Step 4:**  
Repeat this action for each leg attachment point of the frame.

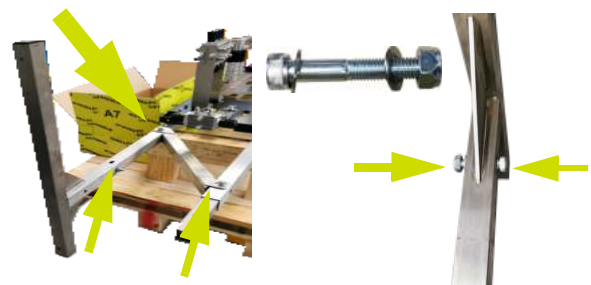
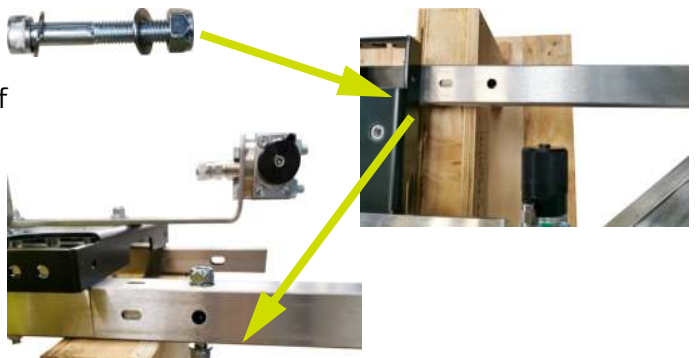

- **Step 5:**  
Once the elements have been tightened, 2 participants are tilted into a vertical position on a flat Cyclomix<sup>®</sup> Evo floor.

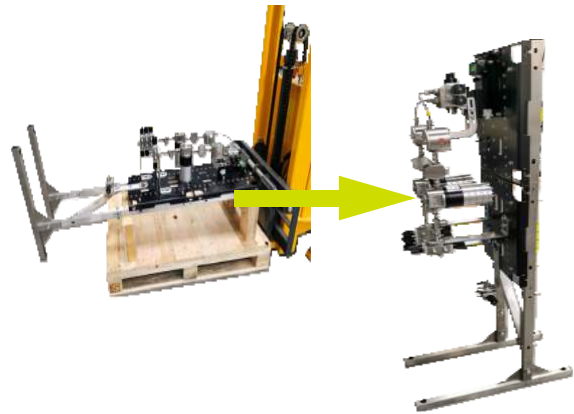

### 5.2.3. Principle of slinging the Cyclomix<sup>®</sup> Evo

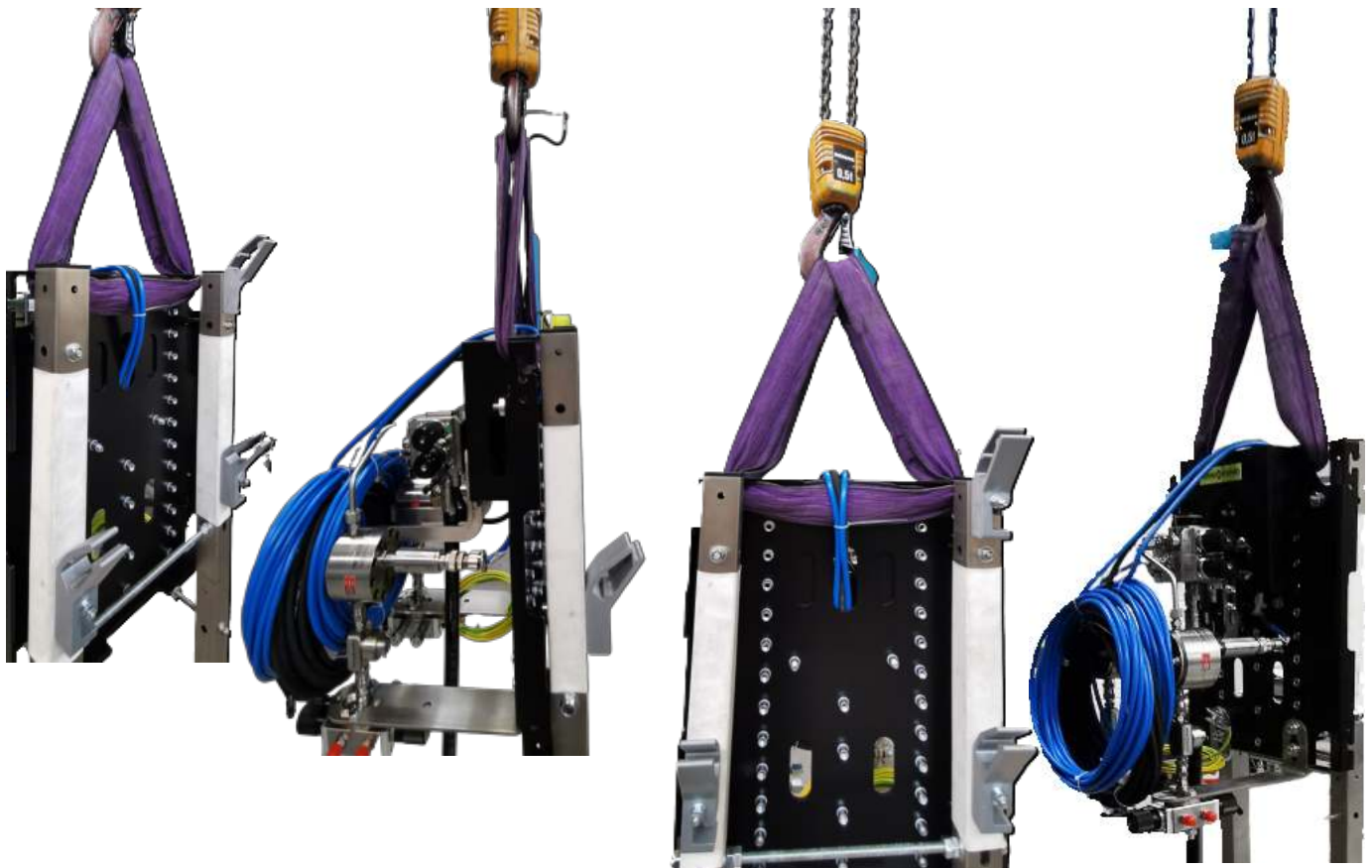

#### 5.2.4. Electrical connection

The Cyclomix<sup>®</sup> Evo can be powered by 220V or 110V..

The electrical connection of the Cyclomix<sup>®</sup> Evo must be made according to the wiring diagram on the N and L terminal blocks located inside the cabinet and provided for this purpose.

A 3-wire cable (2 phases + ground) of 1.5mm<sup>2</sup> must be used.

Check beforehand that it is not damaged.

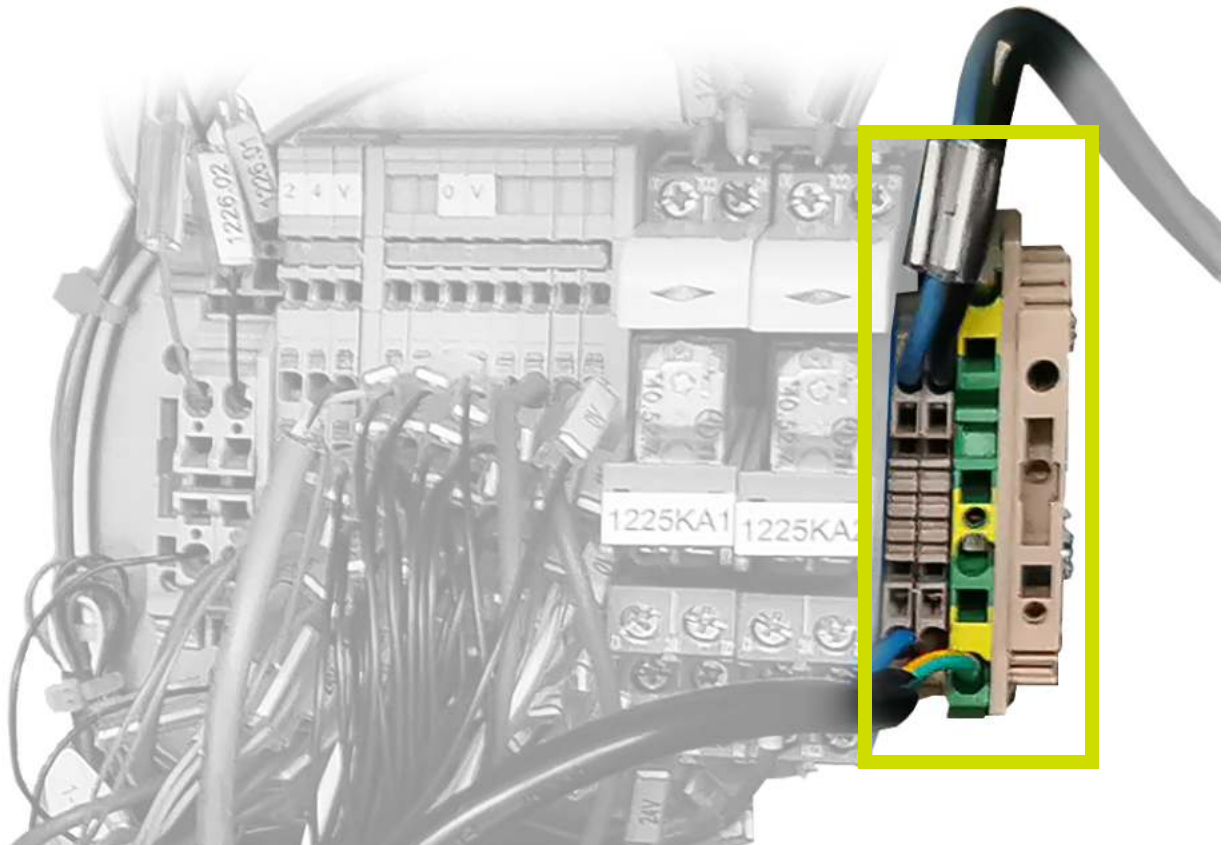

#### 5.2.5. Pneumatic connection

The compressed air supply must be between 5.5 and 7 bar.

Higher supply pressure may result in faster deterioration of some components such as electrovalves.

The compressed air must be free of water, oil and impurities in accordance with ISO 8573.1, 2010 Class 7.5.4.

The pneumatic power supply must be connected to the control panel and to the product plate.

### 5.2.6. Air supply to the box

The air supply of the box is done with a hose of diameter 8x10 at the level of the snap-in connection located under the box.

If the box is not equipped with debistats (AIRLESS or automatic mode) then the supply will be made directly at item 3 of the picture below.

If the box is equipped with one or two debistats, then the power supply is made directly on the connection TE 4 or 5.

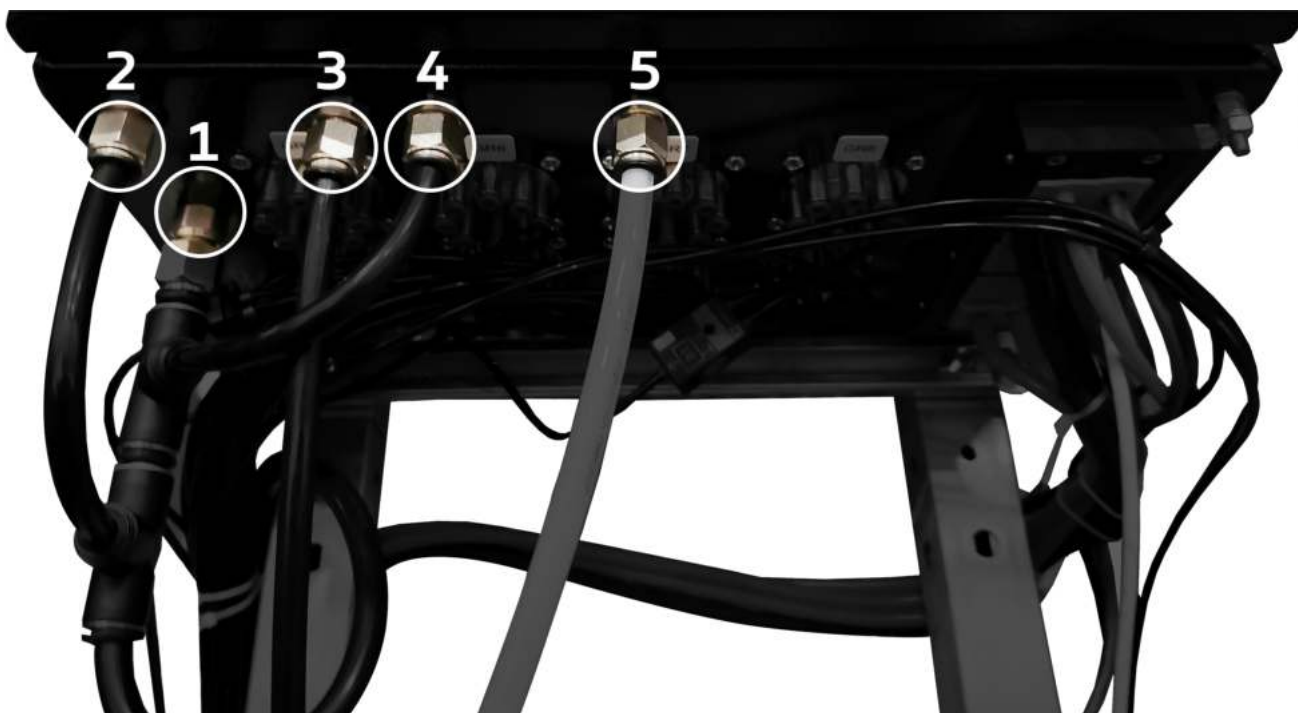

Item	Description
1	Power supply of the box
2	Power supply to debistats 1
3	Air outlet from debistat 1 to gun 1
4	Power supply to debistats 2
5	Air outlet from debistat 2 to gun 2



5.2.7. Location of cable outlets in the main box

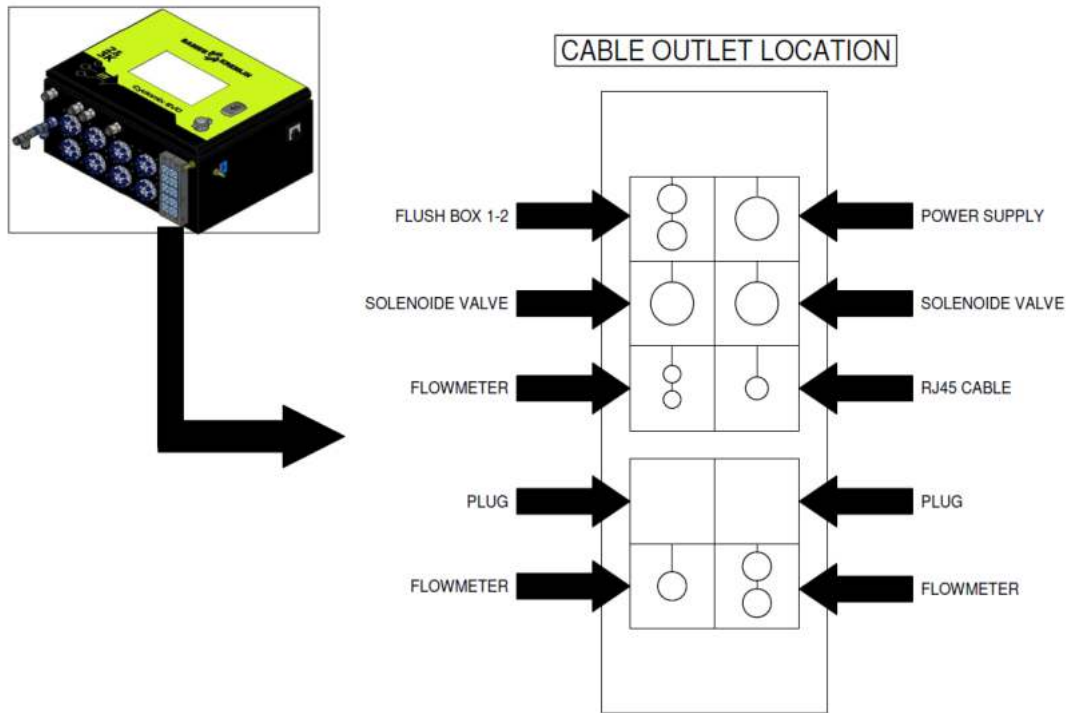

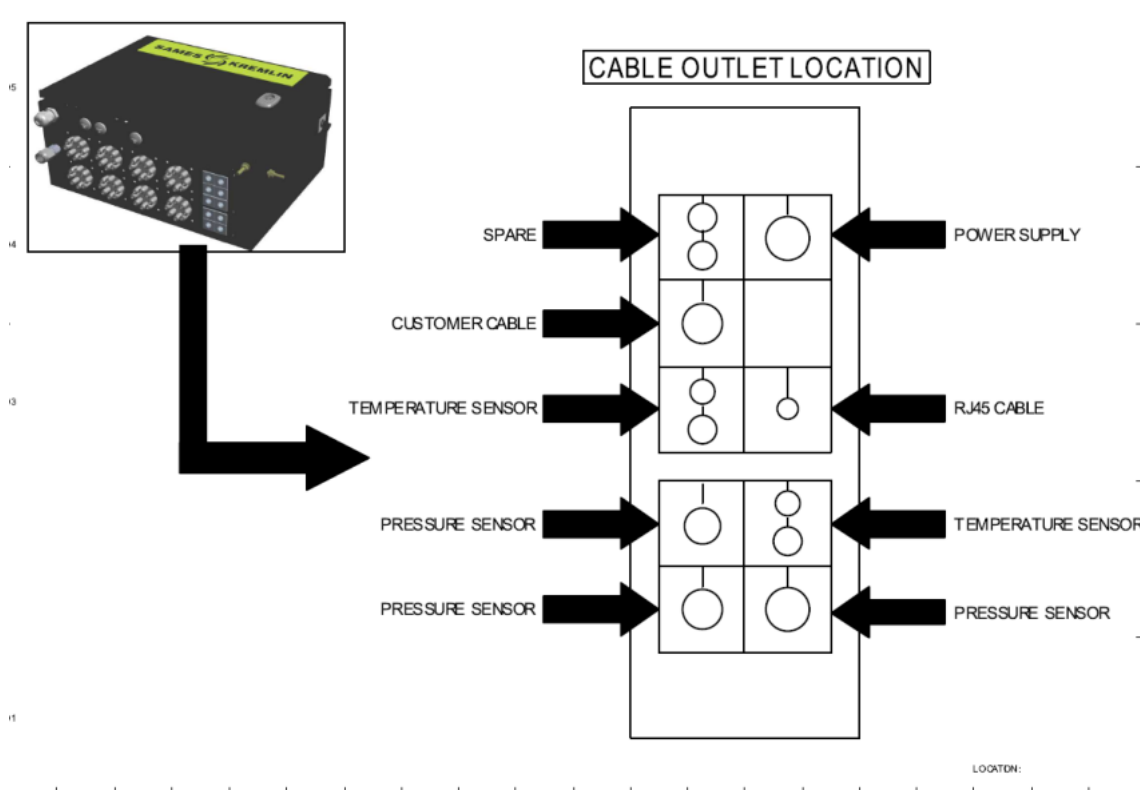

5.2.8. Location of the additional box cable outlets

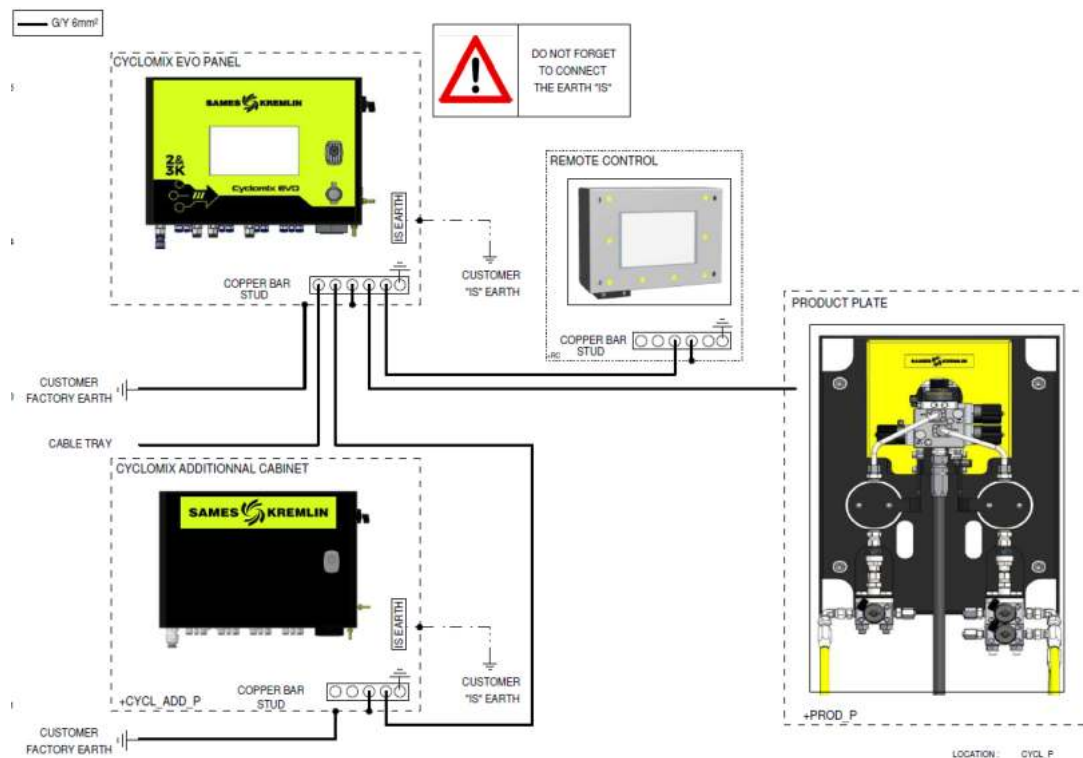

5.2.9. Equipotential bonding of the main box



5.2.10. Equipotential bonding of the main box

Pistolet 1	<b>Production</b>		T : 0.0 °C	
	ROUGE		A : 0.0 Bar	0.0 Bar
			B : 0.0 Bar	0.0 Bar
				
	156.28cc	112.2cc	122.2cc	
Pistolet 2	<b>Débit : 550.80 cc/min</b>		Pistolet 1	
	<b>Potlife pistolet 1 : 23:59:59</b>		Pistolet 2	
	<b>Potlife pistolet 2 : 23:59:52</b>		<p><b>Fin de production</b></p> <p>N° de lot :</p> <p>...</p> <p><b>Stop</b></p>	



### 5.2.11. Equipotential bonding of the remote box

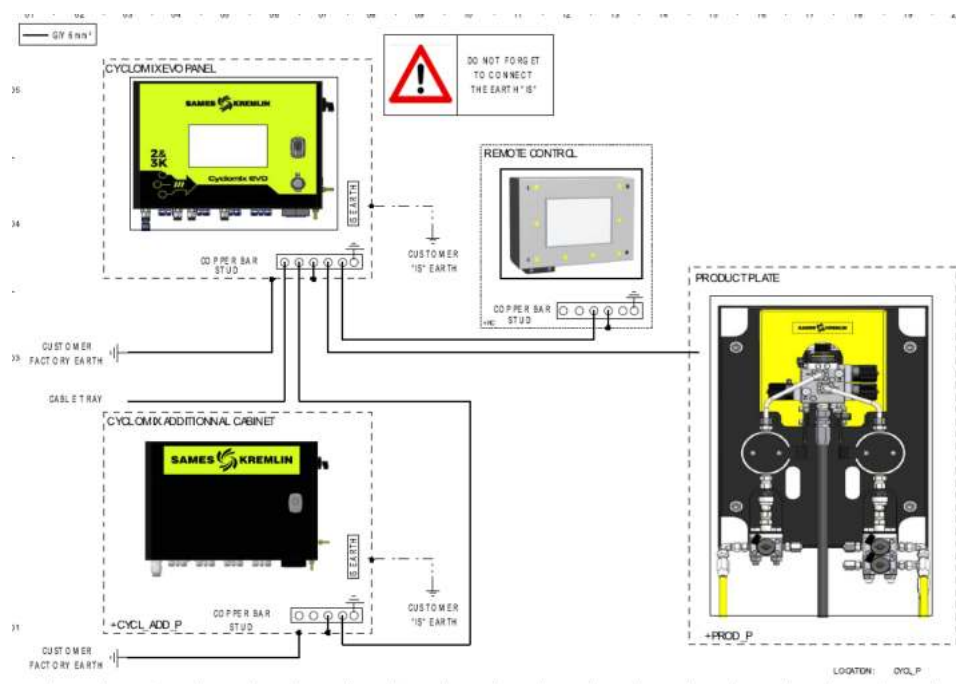

### 5.2.12. Air supply to the product plate

The air connection of the product plate is necessary to supply the electrovalve of the injection valve as well as the AIRCHOP valve.

The air connection must therefore be made at the Y connection located on the side of the support plate as shown in the image below.

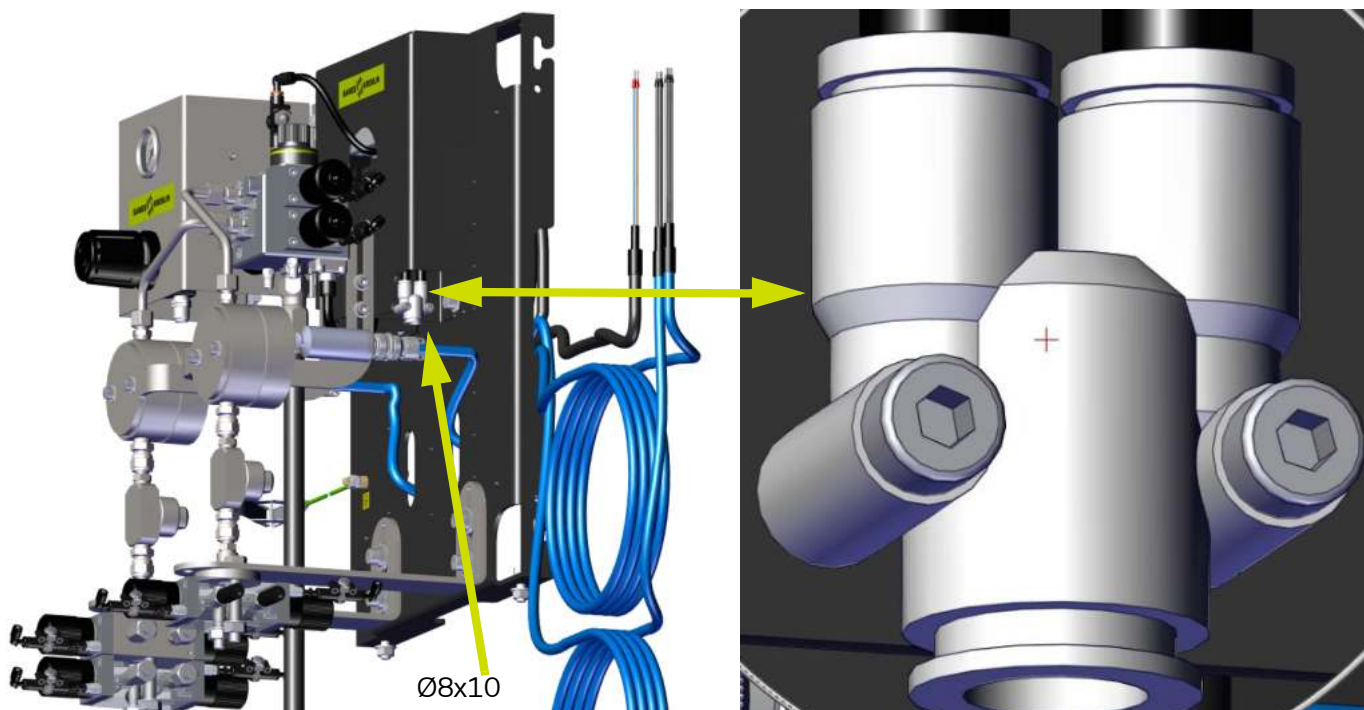

### 5.2.13. Air supply to the spray box

The spray box is used to supply or cut off the spray air that reaches the gun. The air consumption also allows the machine to know if the gun is open or closed thanks to the debistats located in the box. This means that this box must be fed from the outlet of the debistats on the box and then the air supply to the gun will be from this box.

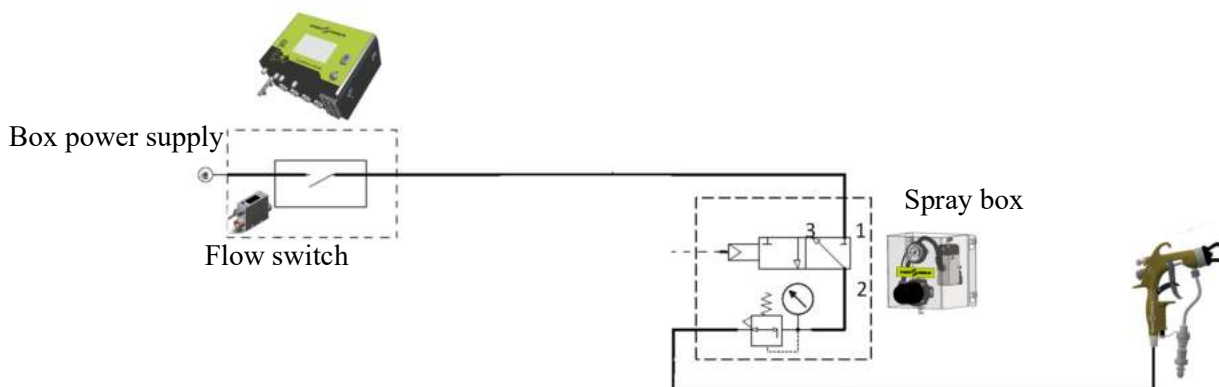
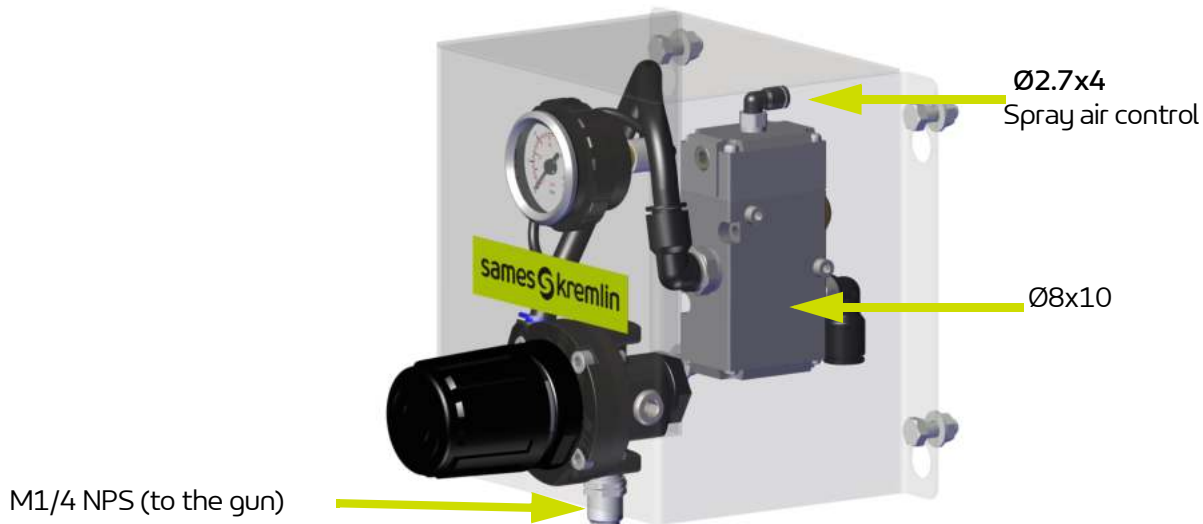

5.2.14. Connection of the flowmeters  
Gear flowmeters – Non ATEX version



Note: only tighten the sensor with your fingers. Using a wrench will damage the flowmeter.  
On the flowmeter side, the sensors are screwed in and locked with the locknut. The sensor must be screwed in order to be in contact with the flowmeter and then it is necessary to lock the locknut in order to avoid that the sensor unscrews in time.

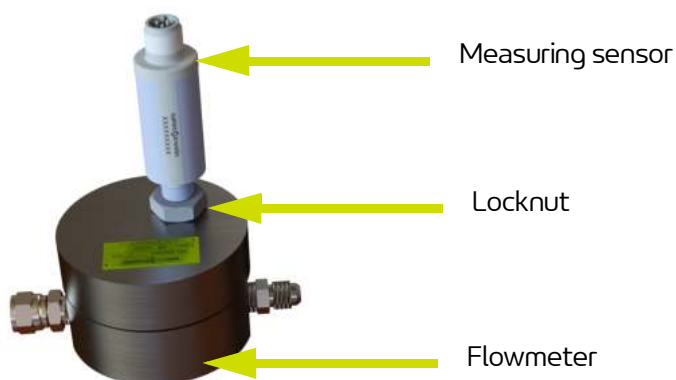

The cables are marked to facilitate the connection of each flowmeter. The connector is screwed on the sensor on one side and on the other side the cable is connected to the terminal blocks located inside the box

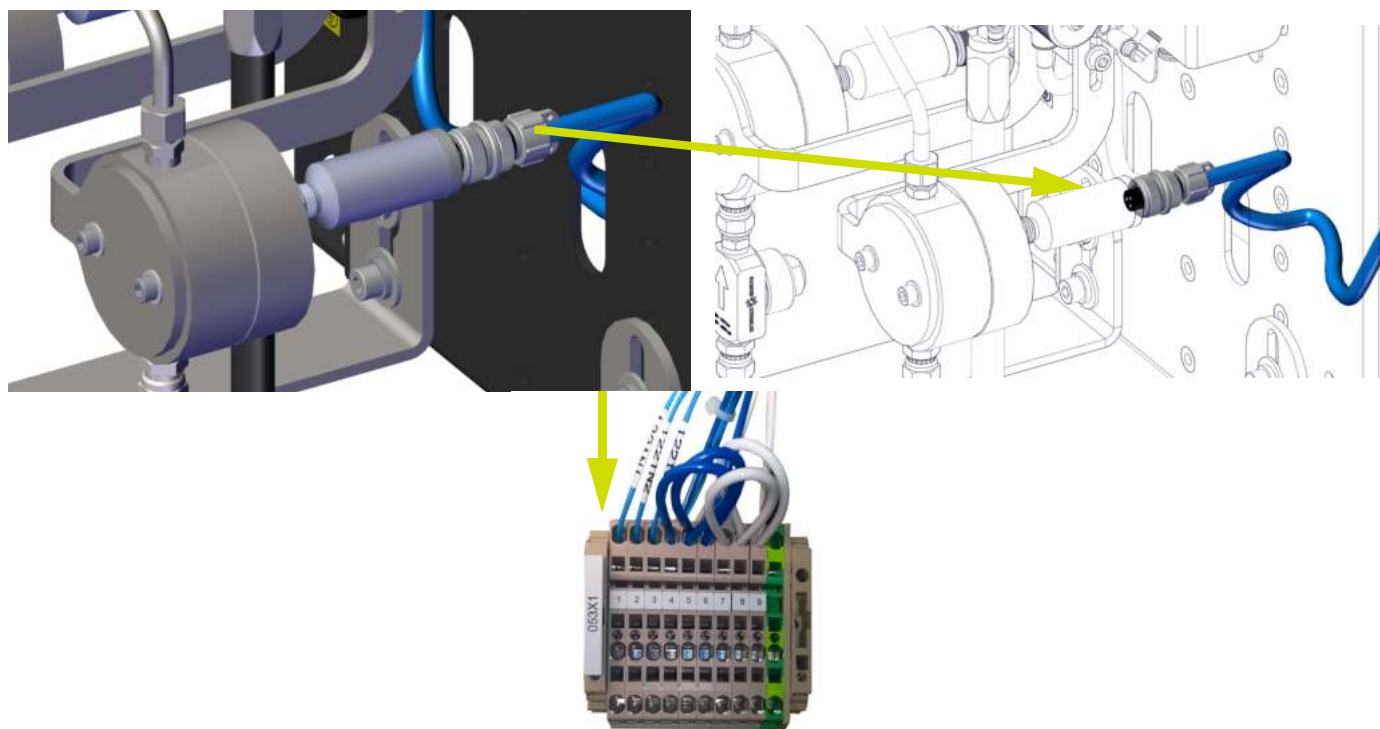

The flowmeter cables are connected to the 053X1 terminal block assembly.

For the flowmeter of component A (base):

- Wire 1 is connected to terminal block 4
- Wire 2 is connected to terminal block 7
- Wire 3 is connected to terminal block 4

For the flowmeter of component B (catalyst):

- Wire 1 is connected to terminal block 5
- Wire 2 is connected to terminal block 8
- Wire 3 is connected to terminal block 2

For the flowmeter of component C (diluent):

- Wire 1 is connected to terminal block 6
- Wire 2 is connected to terminal block 9
- Wire 3 is connected to terminal block 3

**ATEX version**

On the flowmeter side, the sensors are screwed on and locked with the locknut. The sensor must be screwed in so as to make contact with the flowmeter, and then the locknut must be locked to prevent the sensor from unscrewing over time.

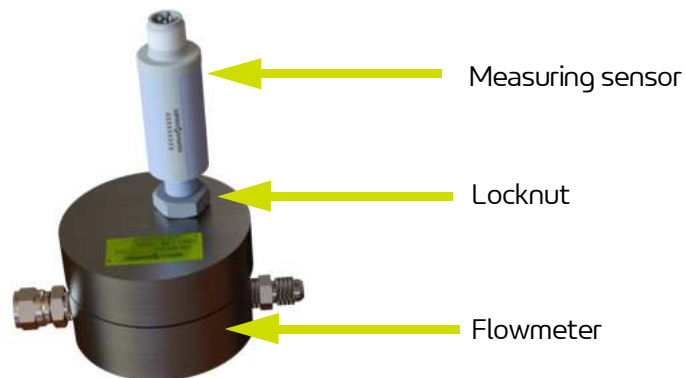

The cables are marked to facilitate the connection of each flowmeter. The connector is screwed on the sensor on one side and on the other side the cable is connected to the intrinsic barriers located inside the box.

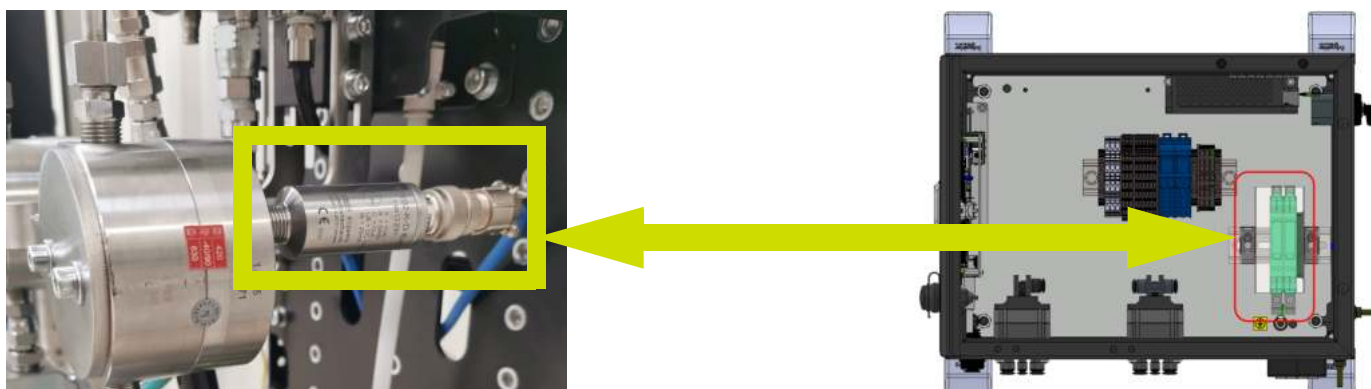

- The cable of the flowmeter A (base) is connected to the intrinsic barrier 053V1.
- The cable of the flowmeter B (catalyst) is connected to the intrinsic barrier 053V2.
- The cable of the flowmeter C (diluent) is connected to the intrinsic barrier 053V3.

For each cable, wire 1 of the cable connects to terminal 1 of the barrier, wire 2 connects to terminal 3 and wire 3 connects to terminal 4.

**Optical fiber version**

These flowmeters are used in the case of an electrostatic application with a water-soluble product. Indeed, during these applications, the whole plate must be electrostatically charged, it is necessary to isolate completely this plate.

The flowmeter used is the same as for the ATEX and NON ATEX versions but the sensor will be different, in this case it is a sensor where the information is transmitted via an optical fiber. The sensor is screwed in the same way as the other sensors

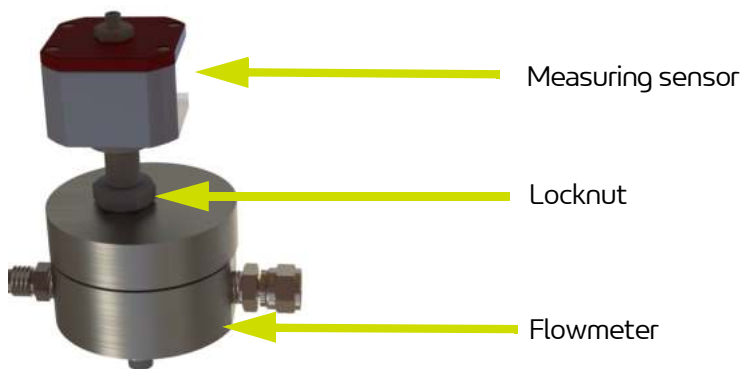

The cables are marked to facilitate the connection of each flow meter. The connector is screwed on the sensor on one side and on the other side the cable is connected to the intrinsic barriers located inside the box.

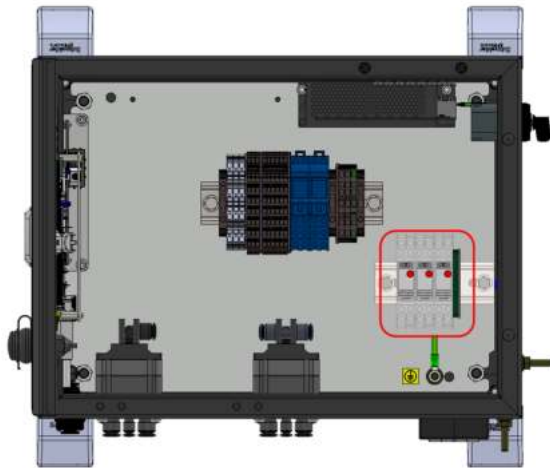

The cable of the flowmeter A (base) is connected by screwing on the one hand to the FOP sensor and on the other hand to the fiber optic receiver RFO1.

The cable of the flowmeter B (catalyst) is connected by screwing on the one hand to the FOP sensor and on the other hand to the fiber optic receiver RFO2.

The cable of the flowmeter C (diluent) is connected by screwing on the one hand to the FOP sensor and on the other hand to the fiber optic receiver RFO3.



5.2.15. 2K gun overview complete option

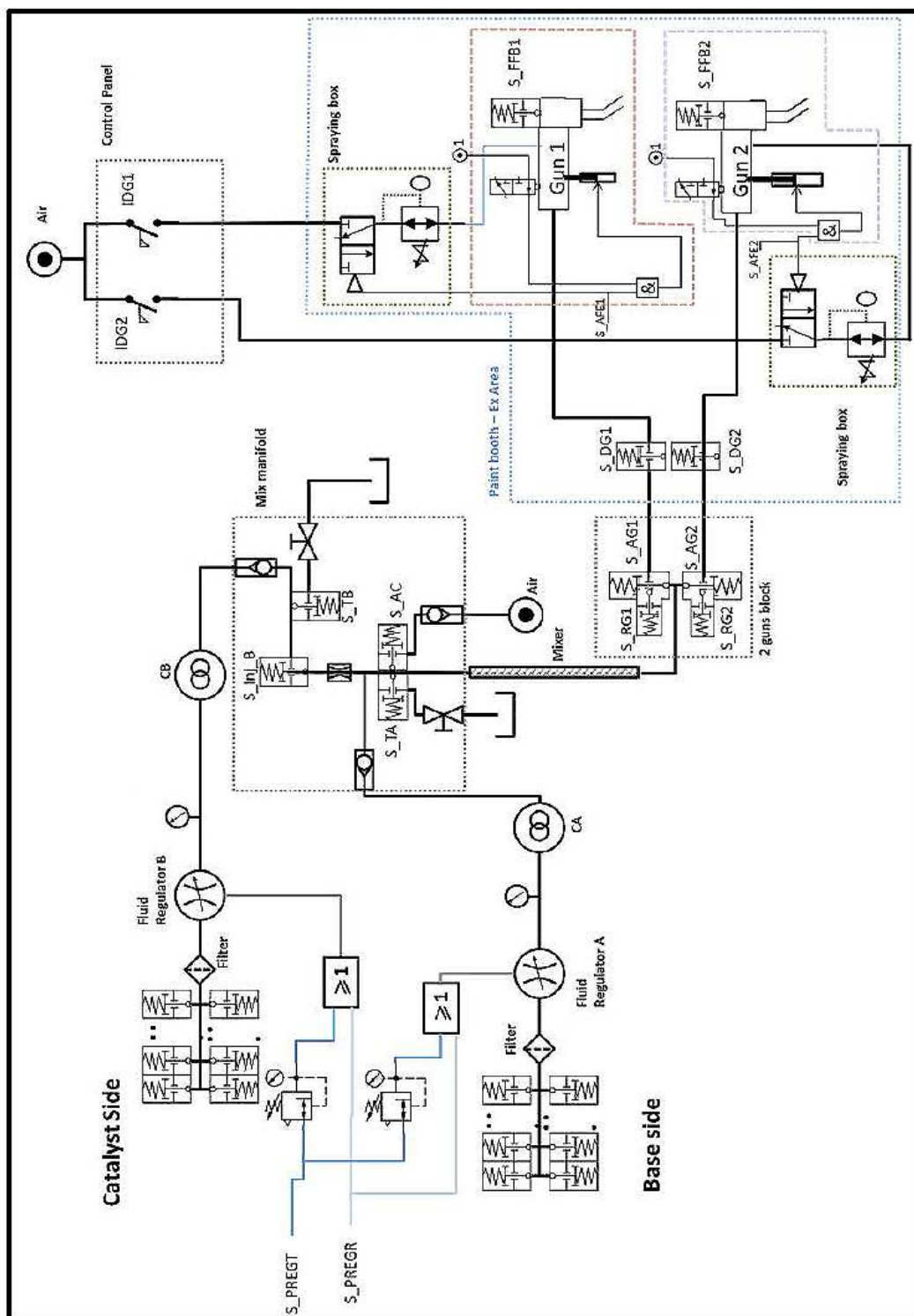

5.2.16. 3K gun overview complete option

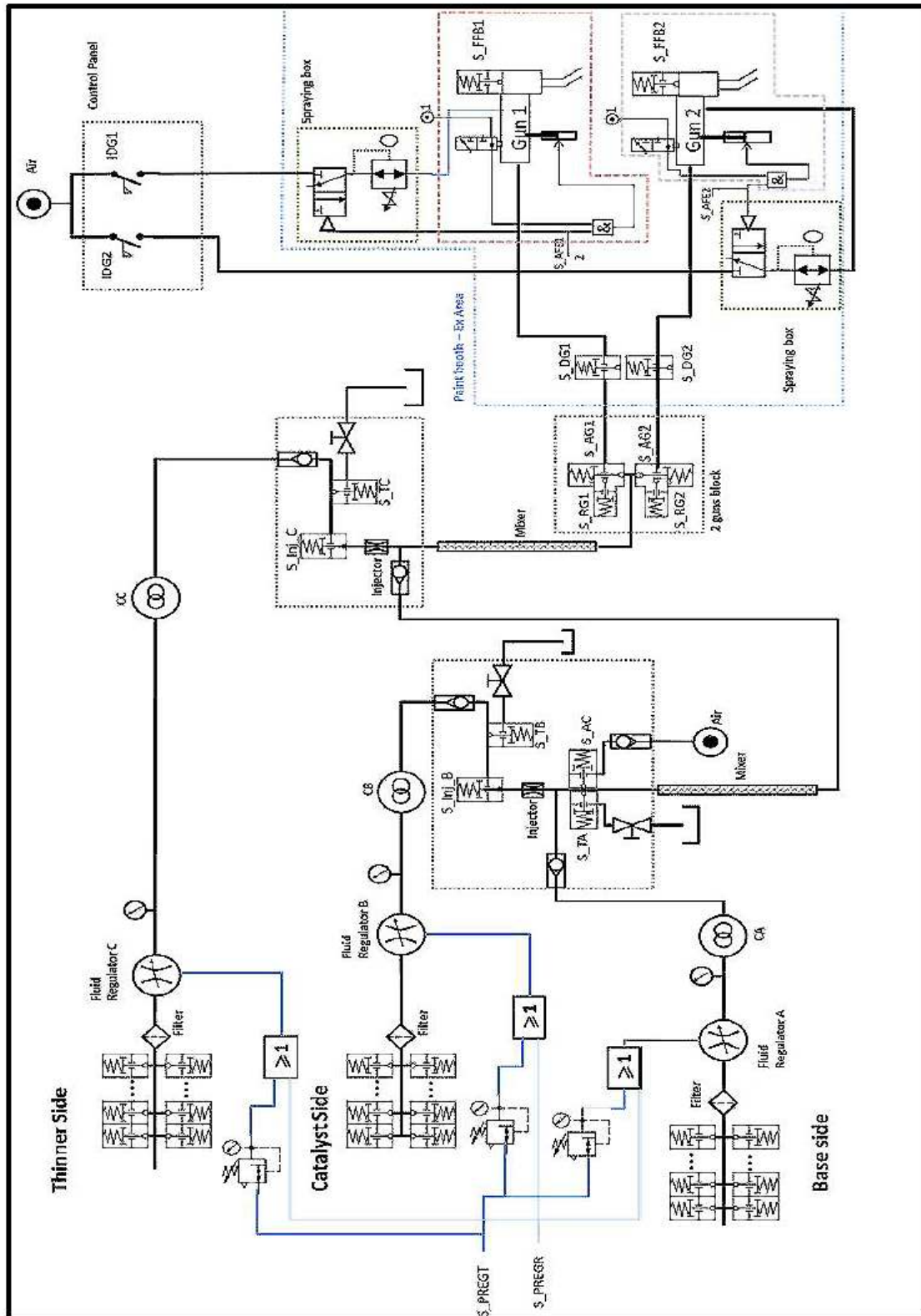



### 5.2.17. Connection of the mixing block

The 2K mixing block consists of 4 valves which are controlled from the main control panel.

The 4 valves are:

- The injection valve,
- The sampling valve on the catalyst side,
- The AIRCHOP valve,
- The sampling valve on the base side.

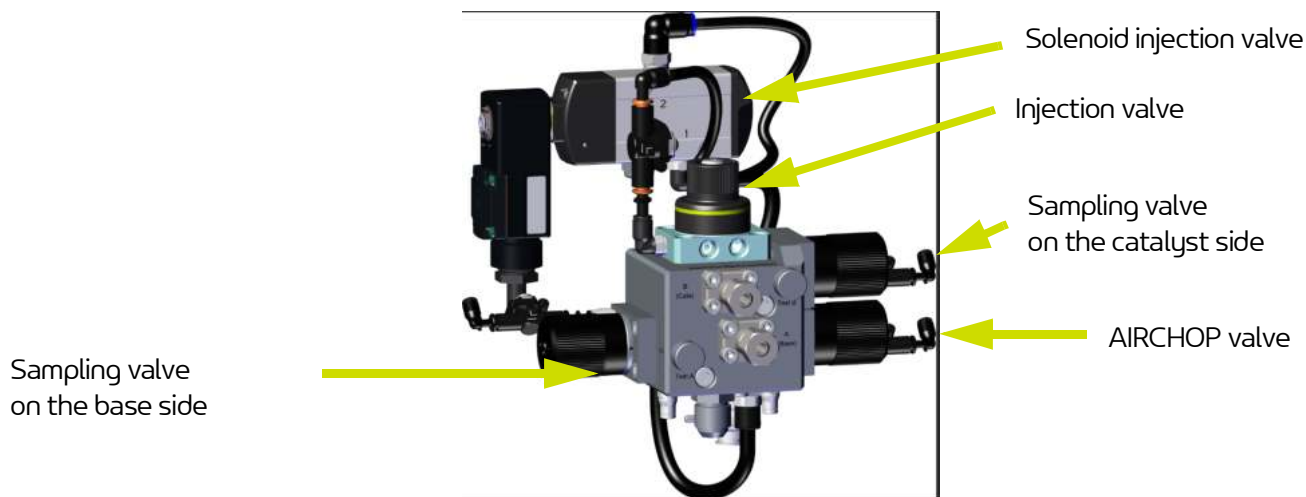

### 5.2.18. Injection valve connections

The injection valve is controlled via output 31 on the DIOB 1 card.

The injection valve is a pneumatic valve controlled by the solenoid valve located behind the protective cover.

It is therefore necessary to connect the solenoid valve electrically.

The cable is already connected on the solenoid side but it is necessary to connect it on the control panel side.

Connect the brown wire on the cable to terminal 1 (low terminal) of the 1226X1 terminal block.

Connect the blue wire to the 0V distribution terminal block at position 6 of the 6th terminal.

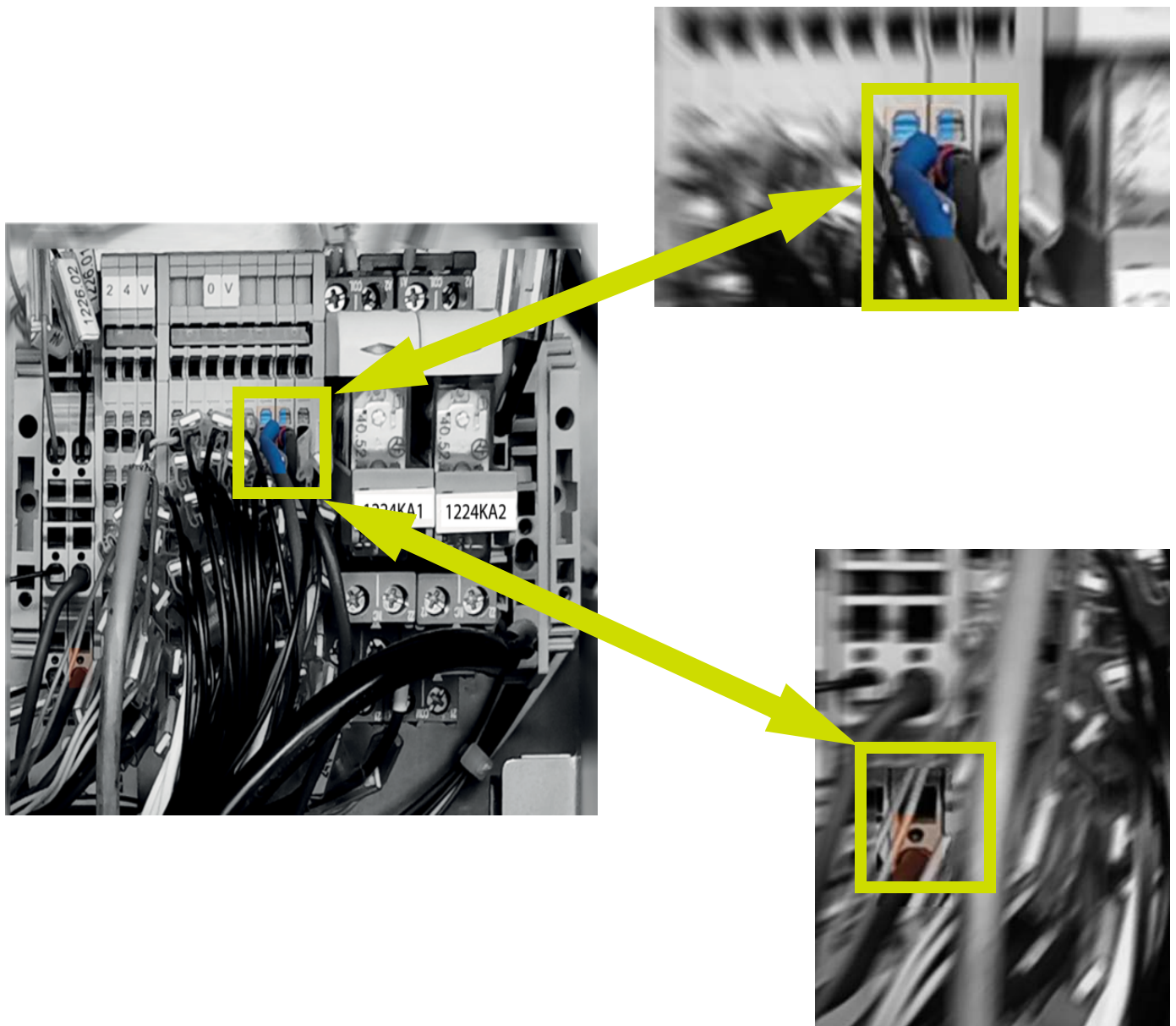

### 5.2.19. Test valves and AIRCHOP connections

The test valves A and B are controlled via the outputs n° 17 and n°18 on the DIOB 1 card and then the solenoid valves 3 and 4 of block n°3.

The AIRCHOP valve is controlled via output 22 on the DIOB 1 card and then the solenoid valve 7 of block n°1.

The connection between the valves and the solenoid control valves is made with a 4mm diameter pneumatic hose.

Connection on the mixing block side

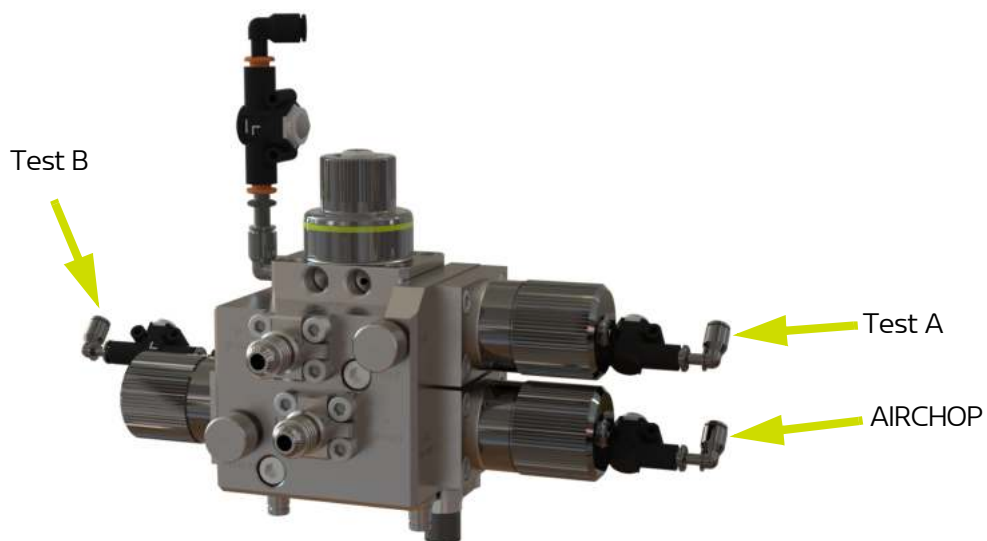

Connection on the cabinet side

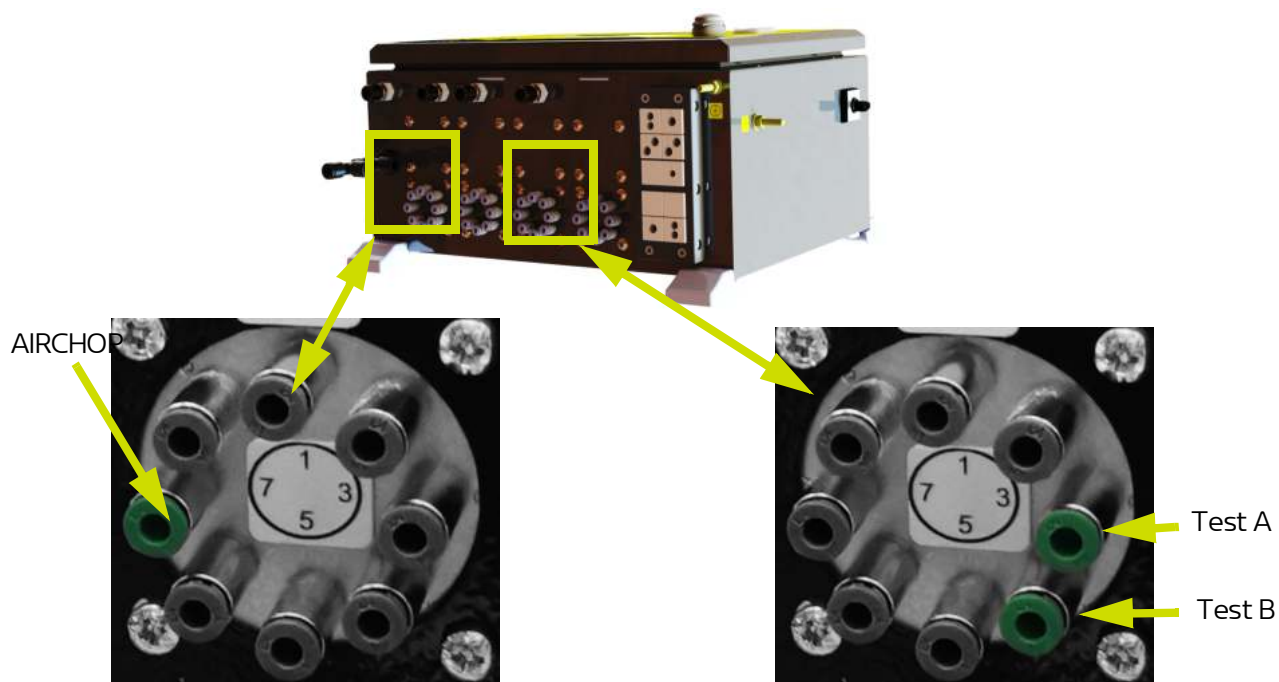

### 5.2.20. Connection of the product valves

As with the mixing block valves, the connection of the product valves is made with a 4 mm diameter hose.

As the distribution of the products is configurable, the connection of the control hoses can only be carried out once the configuration of the products has been completed.

The main cabinet can handle up to 35 products, the addition of an additional EVO+ cabinet will be necessary to handle more than 35 products.

Below is a table showing the correspondence between the output numbers declared in the configuration and the solenoid valves to which the pilot hoses are connected.

Control via I/O DIOB 1 card

Number of product output	1	2	3	4	5	6	7	8	9	10	11
EV block number	Block 1						Block 2				
Position of the solenoid valve	1	2	3	4	5	6	1	2	3	4	5

Control via I/O DIOB 2 card

Number of product output	12	13	14	15	16	17	18	19	20	21	22	23	24	25	26	27	28	29	30	31	32	33	34	35
EV block number	Block 6								Block 7								Block 8							
Position of the solenoid valve	1	2	3	4	5	6	7	8	1	2	3	4	5	6	7	8	1	2	3	4	5	6	7	8

Position of the EV blocks

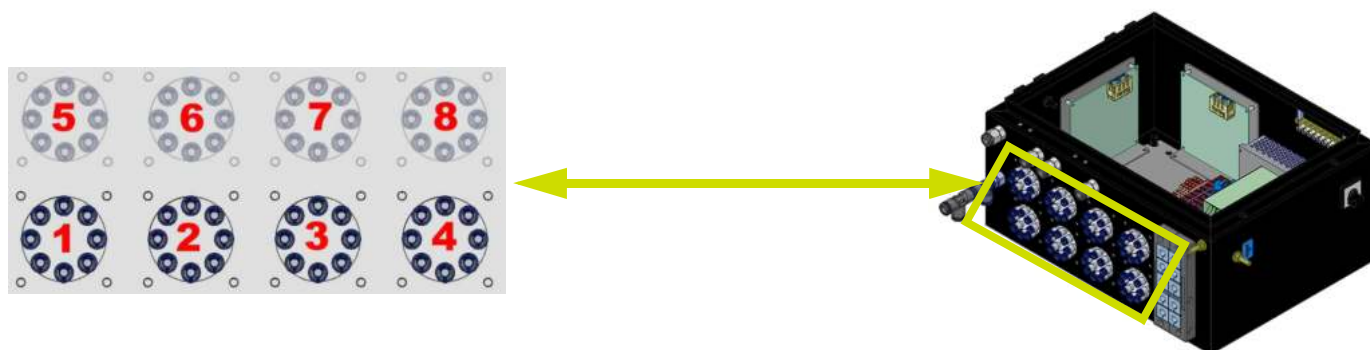

### 5.2.21. Connections of other functions

The various elements must be connected to the solenoid valves according to the table below:

Functions	Air chop	Flushing box Gun 1	Quick drain valve 1	Quick drain valve 2	Test valve A	Test valve B	Test valve C	Flushing FB1	Flushing FB2	Air spraying 1
EV block number	Block 1		Block 3							
Position of the solenoid valve	7	8	1	2	3	4	5	6	7	8

Number of product output	Flushing box Gun 2	Flushing Gun 1	Flushing Gun 2	Gun 1	Gun 2	Working pressure regulator	Flushing pressure regulator	Air spraying 2
EV block number	Block 4							
Position of the solenoid valve	1	2	3	4	5	6	7	8

### 5.2.22. Connection of an electrostatic box

If the applicator is an electrostatic gun, it is necessary to connect the high voltage box to the Cyclomix® Evo so that the high voltage is cut off during the flushing or tinting phases.

For this purpose, 2 relays are provided, 1 per gun, inside the main box.

The 1224KA1 relay corresponds to gun 1 and the 1224KA2 relay corresponds to gun 2.

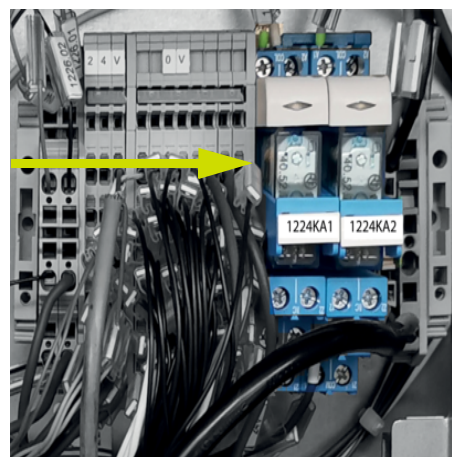

When using the GNM6080, it is possible to connect the "Trigger +" contact ref. 110001967 directly to contact 24 of the relay and also connect the 24V to contact 21.

It is also necessary to connect the "Trigger -" contact of the connector ref. 110001967 on the 0v terminal block.

It is also possible to connect the wire corresponding to the 220V power supply phase of an electrostatic box directly to contact 24 of the relay and by connecting the phase of the main power supply of the box to contact 21 of the relay.

In this configuration, it is necessary to take the 220V downstream of the disconnecting switch of the box in order to avoid the maintenance of the power supply of the electrostatic box during a cut of the box.

It will also be necessary to connect the neutral of the electrostatic box to the power supply terminal of the box.

### 5.2.23. Leak tests

Leakage tests of the various components are carried out in the factory.

However, transport may have caused some parts to become unscrewed, so it is advisable to check all tightenings before putting the machine into production.

Check also all connections made of the color changers and between the machine and the applicator.

#### 5.2.23.1. Check the tightness of the colors changers

Start up the solvent pumps at low pressure and then, while checking that there is no leakage of product from the supply connections of the color changers, gradually increase the pressure until the working pressure is reached.

Repeat the same operation of all the colors.

#### 5.2.23.2. Check the tightness of the different parts of the machine

Although all components are factory tested, it is possible to test the tightness of each valve via the maintenance menu. For this purpose:

- Open the maintenance menu and go to page 10.

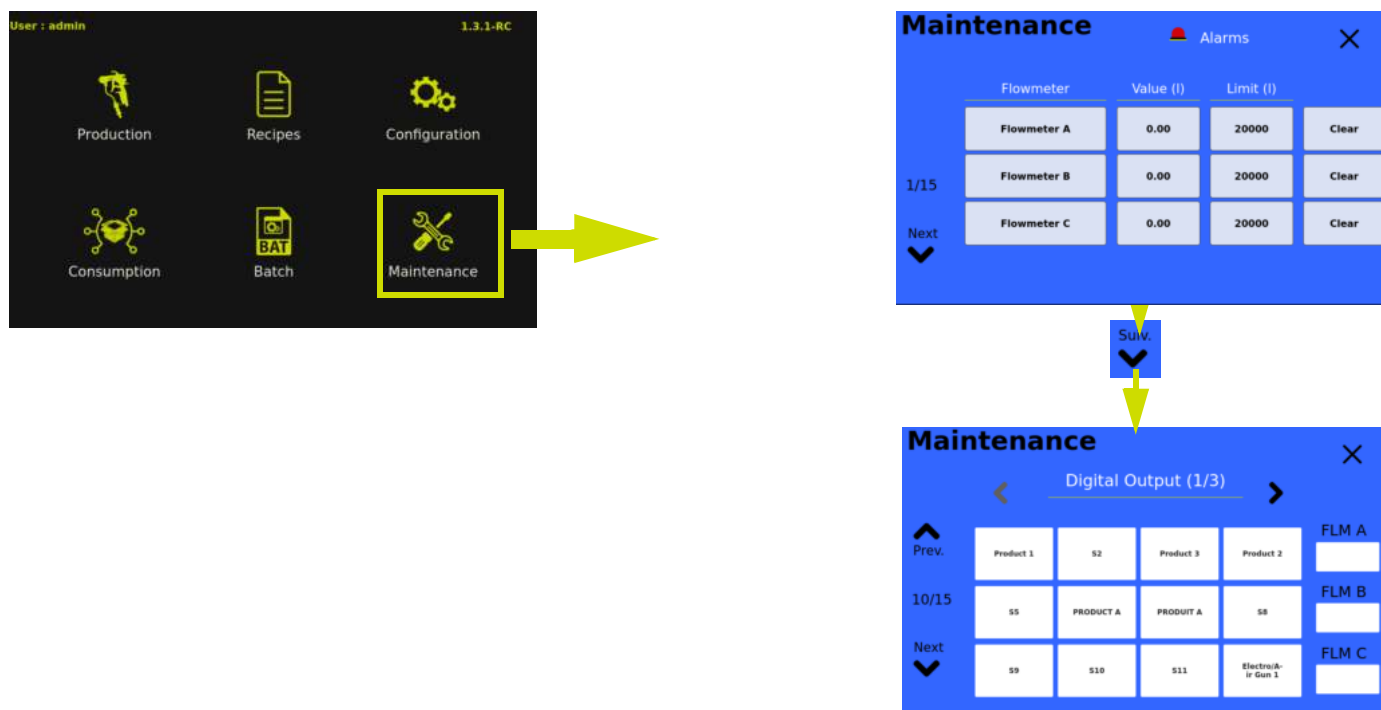

Referring to the fluid diagram:

- Open each valve in the system in turn one at a time and then the gun.
- Check that the flow meter indicator lights are not flashing green.  
A flashing may occur during the opening transitory period of the valves while the different parts of the circuit are pressurized, but once the pressure has stabilized the indicator should no longer flash.  
In fact, the lights reflects the pulses seen by the flowmeters, so if the light is flashing, it means that product is flowing. For example: Machine with 2 guns management without product regulator.

### Base circuit test

- **Step 1:**  
Open the 2-gun block (activate the 2 outputs of the block).
- Open the guns.
  - Fluid can flow out while the pressure drops and then it should stop.  
If this is not the case, then it means that color change valve is poppet and stern is not sealing.
- If the color changers are sealed, proceed to step 2, otherwise make the necessary repairs.  
The color of the flowing product can identify the defective valve.
  - Close the 2-gun block.
- **Step 2:**  
Open a valve on the base side of the color changer.
  - A pressure build-up occurs between the color changer and the 2-gun block that can cause momentary pulses.
  - If the 2-gun block is tightly sealed, then no product should flow out, so the flowmeter indicator A should be steady (white or green).  
However, if it is not sealed, then fluid will come out of the gun and the A flow meter light will flash.

### Catalyst circuit test

- **Step 1:**
  - Open the injection valve.
  - Open the 2-gun block (activate the 2 outputs of the block).
  - Open the guns.
    - Fluid can flow out while the pressure drops and then it should stop.  
If this is not the case, then it means that color change valve is poppet and stern is not sealing.
  - If the color changers are sealed, proceed to step 2.  
If not, make the necessary repairs.  
The color of the flowing product can identify the faulty valve.
  - Close the injection valve.



**Step 2:**

- Leave the 2-gun block open.
- Open a valve on the color changer catalyst side.
  - A pressure build-up occurs between the color changer and the injection valve that can cause momentary pulses.
- Opens the guns.
  - If the injection valve is tight, then no product should flow out, so the flowmeter indicator B should be steady (white or green).  
However, if it is not sealed, then fluid will come out of the gun and the flowmeter indicator light B will flash.
- Close the 2-gun block.

**Step 3:**

- Open the injection valve.
  - A pressure build-up occurs between the injection valve and the 2-gun block, which can cause momentary pulses.
- Opens the guns.
  - If the 2-gun block is tight, then there is no product flowing out, so the flowmeter indicator light B should be steady (white or green).  
However, if it is not sealed, then fluid will come out of the gun and the flowmeter indicator light B will flash.
- This procedure is of course to be adapted according to the configuration of the machine.

**5.2.24. Compatibility - hoses - product -pressure**

- The user of the equipment shall ensure that the working pressure stated on the hose is equal to or less than the maximum pressure that can be delivered by the supply system.
- Do not use hoses that have been bent and not coiled.
- Use only hoses that are in good condition and free of damages and wear.
- Use only anti-static grade air hose to connect the pump to the gun.
- All connections must be tight and in good condition.

**5.3. Shutdown and start-up procedures**

**5.3.1. Installation stop**

The automatic cycles are stopped by pressing the stop button on the HMI.

**5.3.2. Switching off**

- Be sure to clean the machine properly before turning it off as this can lead to clogging of the mixed circuit. Before shutting down the system, it is recommended to drain the hoses to prevent them from clogging. To drain the hoses, start the «Machine flushing» cycle. Turn off the pump and open the drain valve to get the pressure down.
- The power is turned off using the switch located on the side of the main cabinet.

**5.3.3. Restart after power outage**

After a power failure, it is necessary to perform a cleaning cycle before resuming production with a clean machine.

**5.4. Specific settings**





The catalyst pressure must always be higher than the base pressure.

## 6. Maintenance

Preventive maintenance is an inherent part of production and ensures the reliability of the installation. As a reminder, the performance of the equipment can only be guaranteed if a minimum of control and cleaning operations are performed on this equipment.



**The dirt and wear of the equipment depends on the operating and application conditions as well as on the production rate.**

## 6.1. Maintenance summary table

The frequency of maintenance indicated in the procedures below is only indicative.  
The user will have to create his own maintenance range as he uses the **Sames** equipment.

Procedure	Detail	Duration	Frequency
	<b>Maintenance of the concerned sub-assembly screen filter – screen seals</b>		
	<b>Replacement</b>		
	Remove the screen filter.	2mn30s	1000 hours
	Reassemble the screen filter.	2mn30s	1000 hours
	Remove the seals.	1mn	2000 hours (Once a year)
	Reassemble the seals.	1mn	2000 hours (Once a year)
	<b>Maintenance of the concerned sub-assembly regulator body – fluid air diaphragm</b>		
	Remove the fluid air diaphragm.	5mn	2000 hours (Once a year)
	Reassemble the fluid air diaphragm.	5mn	2000 hours (Once a year)
	<b>Maintenance of the concerned sub-assembly regulator body – seat, spring and ball</b>		
	Remove the seat, spring and ball.	2mn30s	2000 hours (Once a year)
	Reassemble the seat, spring and ball.	2mn30s	2000 hours (Once a year)
	<b>Maintenance of the concerned sub-assembly injection valve – cartridge replacement</b>		
	Remove the injection valve.	5mn	2000 hours (Once a year)
	Reassemble the injection valve.	5mn	2000 hours (Once a year)
	<b>Maintenance of the concerned sub-assembly color changers – cartridge replacement</b>		
	Remove the color changer - Cartridge replacement.	8mn30s	(Once a year)
	Reassemble the color changer - Cartridge replacement.	8mn30s	(Once a year)
	<b>Maintenance of the concerned sub-assembly color changers – needle and pneumatic valve replacement</b>		
	Remove the color changer. Needle and pneumatic valve replacement.	5mn	(Once a year)
	Remove the color changer. Needle and pneumatic valve replacement.	5mn	(Once a year)
	<b>Maintenance of the concerned sub-assembly mixer</b>		
	Remove the mixer.	5mn	(Once a year)
	Reassemble the mixer.	5mn	(Once a year)
	<b>Maintenance of the concerned sub-assembly flowmeter</b>		
	Remove the flowmeter.	5mn	4000 hours (Once every 2 years)
	Reassemble the flowmeter.	5mn	4000 hours (Once every 2 years)

### 6.1.1. Maintenance video

Please refer to the online maintenance video on the product page.



The assembly and disassembly operations are specified.

### 6.1.2. Additional maintenance

Please refer to the following documentations:

- 582.071.110-EN - 2105 COLOR CHANGERS
- DRT7115 E - 2022/11 Nanogun+ Airmix<sup>®</sup> - GNM 6080 LR- HR- MR Versions
- DRT7105 G - 2022/11 Nanogun+ Airspray - GNM 6080 LR- HR- MR Versions
- 582163110-EN - 2303 AIRMIX<sup>®</sup> PRESSURE REGULATOR WITH CARTRIDGE
- 582106110-EN - 1902 LP PILOT PRESSURE REGULATOR

## 6.2. Preventive Maintenance Plan – PMP 582165110

[see § 9.1 page 159](#)

The proposed preventive maintenance plan aims to define in an exhaustive way, the actions of checking, replacement and cleaning of the installed **Sames** equipment.

In order to anticipate breakdowns and malfunctions that may be due to technical deviations of the installation, the preventive maintenance plan annexed to the user's manual recalls the routine maintenance operations necessary for a better comfort in the use of the production tool.

Depending on the skills, area of responsibility and clearance of each person involved, the preventive maintenance plan can be divided into two distinct levels: level 1 and level 2:

- **Level 1:** first level maintenance is essentially composed of visual control and cleaning operations of some elements of the equipment. To limit this level, only the specific tools provided with the equipment will be used. This first level of maintenance is generally taken care of by paint operators or installation managers.
- **Level 2:** the second level maintenance completes the first level by more complex disassembly operations requiring electrical engineering tools. This second level is generally handled by the factory maintenance department.

### 6.2.1. Pressure relief procedure



**Prerequisite: pressure relief of the circuit (s) during a maintenance operation (filter check, equipment replacement).**

### 6.3. Servicing

These maintenance operations can be performed online. Before any intervention, refer to the health and safety instructions ([see § 1.5 page 19](#)).

### 6.4. Replacement

The following maintenance operations must be performed in the workshop.

#### 6.4.1. Starting up the EtherCAT bus

##### 6.4.1.1. Introduction

The main network of the machine is the EtherCAT protocol. It is essential because it allows the inter-card communication and especially the control of the valves.

Therefore, it is important to check that the recorded bus configuration is correct.

##### 6.4.1.2. Configuration screen

- **Step 1:**  
The bus is configured in the Maintenance menu page 14.

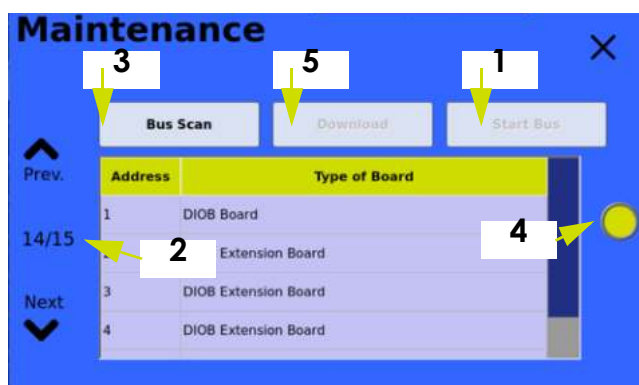

#	LED status	Description
1	Bus status	Red, when the bus is not started. Green, when the bus is started. The machine can go to produce.
2	List of the cards	The list shows all the daughter cards that are saved in the configuration. After a scan (3), the list shows all the cards that are detected on the machine.
3	SCAN button	Pressing the button starts a network scan (detection of branch cards).
4	Download	This button allows you to save and load the topology (configuration) present at the screen.
5	Start	This button is used to restart the bus after its configuration.

##### 6.4.1.3. Topology change (add/remove)

- **Step 1:**  
For example, if the topology of the machine contained only one card: DIOB, here is the screen that would be visible in maintenance (opposite).



- **Step 2:**  
Later, if the user needs a temperature sensor, he will have to add an analog card (ANAB).
  - After wiring this new card, the user will be able to restart his box.
  - At start-up, this is the message that should be displayed.



- **Step 3:**  
After acknowledging this message, the user will be automatically redirected to the maintenance screens (opposite) to configure his network.



- **Step 4:**  
The configuration on the screen no longer corresponds to its installation. To update it, the user must:
  - Press the scan button, a confirmation message appears.
  - Press YES.





- **Step 5:**  
Wait for the end of the scan.

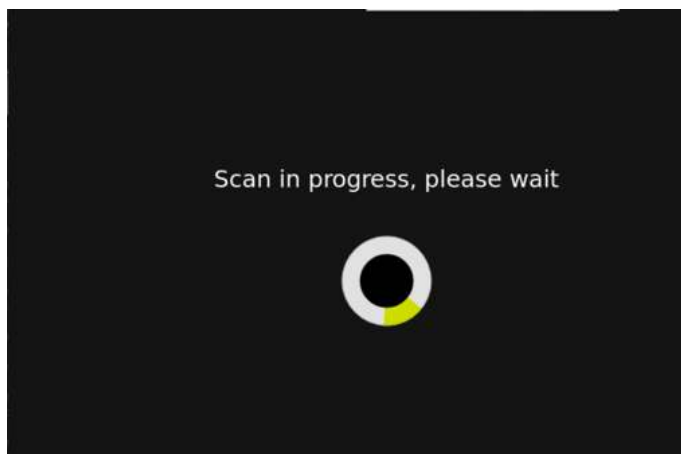

- Result: the detected topology is displayed (see below).

**Maintenance** ✕

⬆ Prev. 14/15 ⬇ Next

Address	Type of Board
1	DIOB Board
2	DIOB Extension Board
3	DIOB Extension Board
4	DIOB Extension Board

- If a topology is not valid, the card name will be displayed in red. Example on the right.

**Maintenance** ✕

⬆ Prev. 14/15 ⬇ Next

Address	Type of Board
1	DIOB Board
2	DIOB Extension Board
3	DIOB Extension Board
4	DIOB Extension Board

- Step 6:**  
 When there are several cards of the same type, it can be difficult to differentiate between them. To overcome this difficulty, it is possible to «identify» the cards.  
 To do this, the user selects the line of the card he wants to locate: a LED will flash for 20 seconds on the selected card.



- Step 7:**  
 If all the cards are detected, the user can press the Download button (a confirmation message will appear). Result: example of screen displayed (below.).

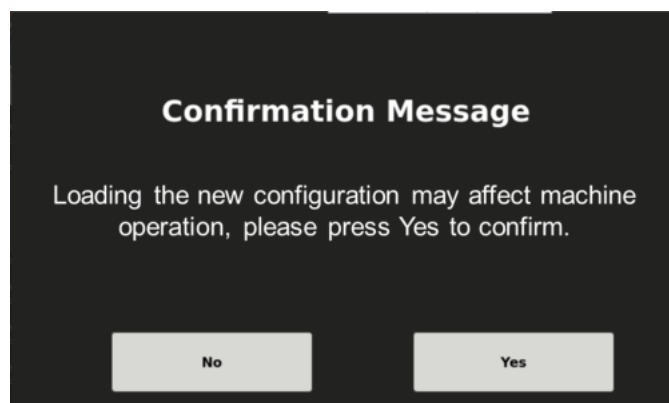

- Step 8:**  
 At the end of the download, the button will be grayed out. The user can start his bus by pressing the Start button.

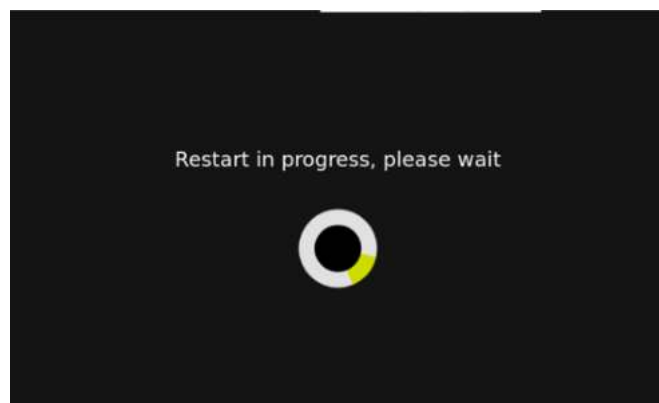

- **Step 9:**  
If everything goes well, the bus starts (see Bus status) and it will be possible to produce.

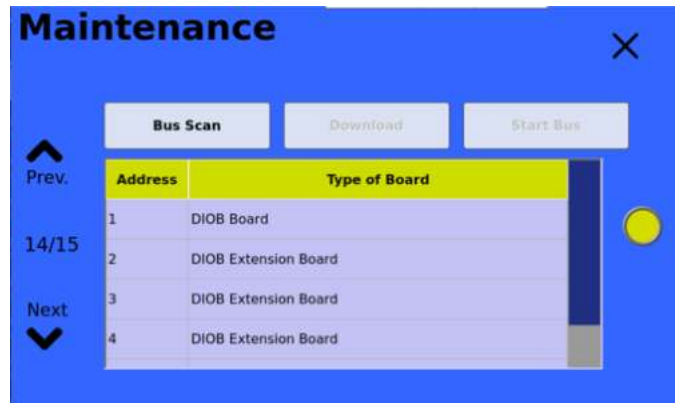

#### 6.4.1.4. .Replace a card

- **Step 1:**  
Wait for the end of the scan.  
If a card is defective, it can be replaced without reconfiguring the bus. At the next power up, the configuration will be updated automatically.  
However, if more than one card is replaced or if the order of the cards is changed, it will be necessary to reconfigure the bus.



## 7. Troubleshooting

Default wording	Automatic action	Expected validation	Action following to validation	Trigger	Causes	Remedies
B/A ratio error - Low limit	Closing of all valves (CTM, Injection, Gun) Display of the default on the screen Passage	Validation by the user	Switching to the regeneration mode and then production	The B/A ratio minimum tolerance has been reached. (Not enough B product).	Incorrect setting of the ratio tolerance. The supply pressure of the B component is too low. Incorrect gain setting or too much flow. The injector is too small. The injector of the B component is clogged or damaged. The B flowmeter is defective.	Check the B/A ratio tolerance. Change if necessary with a minimum of + /- 1%. Increase the supply pressure of B component while maintaining a delta of pressure of about 15% between the B product pressure and the A product pressure. Check the correct operating of the flowmeter and the sensor. Clean and replace if necessary. Check the correct operating of the flowmeter and the sensor. Clean and replace if necessary.
B/A ratio error - High limit	Closing of all valves (CTM, Injection, Gun) Display of the default on the screen	Validation by the user	Switching to the regeneration mode and then production	The B/A ratio maximum tolerance has been reached (Too much B component).	Incorrect setting of the ratio tolerance. The supply pressure of the B component is too high. Incorrect gain setting or too much flow. The injector has a too large diameter. The B flowmeter is defective.	Check the B/A ratio tolerance. Change if necessary with a minimum of + /- 1%. Reduce the supply pressure of the B component.  Check and adjust if necessary. Replace the injector with a smaller one. Check the correct operating of the flowmeter and of the sensor. Clean and replace if necessary.
Maximum flow error	Display of an alarm message	NO		The flow rate is higher than the programmed maximum flow rate.	Leak in the circuit. No tip on the gun or the tip is worn out. Pressure on the fluid regulator at gun is too high.	Check for leaks (static mixer, fittings, seals,...). Repair and/or replace. Check that the tip is present and not worn. Adjust the fluid pressure at the gun.

Default wording	Automatic action	Expected validation	Action following to validation	Trigger	Causes	Remedies
Minimum flow error	Display of an alarm message	NO		1 or 2 guns are opened and the flow rate is lower than the minimum programmed flow rate.	Nozzle clogged Fluid supply pressure too low	Check the tip. Check that the pressures are sufficient.
A flow / trigger error	Closing of all valves (CTM, Injection, Gun) Display of the default on the screen	Validation by the user	Swiching to regeneration mode if the machine was in production or restarting priming process if the machine was in the «Priming» phase	The dispenser of the robot sends the open gun information but the PLC does not receive a lulse from the A flowmeter within the set time interval (Gun trigger time without paint)	Defective dispenser. The painter triggers the gun only with air. The A flowmeter is blocked, the sensor cable is not properly connected or the sensor is defective.	Check the absence of air leakage, check the correct tightness of fittings, check the dispenser. Check the correct operating of the input on the card. Inform the painter not to pull the trigger without letting the product flow or change the " Air Gun Trigger" setting. Check the flowmeter. Make sure the gears are turning freely. Check the correct operating of the sensor. Repair or replace.
A flow / trigger error	Closing of all valves (CTM, Injection, Gun) Display of the default on the screen	Validation by the user	Swiching to regeneration mode if the machine was in production or restarting priming process if the machine was in the «Priming» phase	The dispenser of the robot sends the open gun information but the PLC does not receive a pulse from the A flowmeter within the set time interval (Gun trigger time without paint)	Defective dispenser. The painter triggers the gun only with air. The A flowmeter is blocked, the sensor cable is not properly connected or the sensor is defective.	Check the absence of air leakage, check the correct tightness of fittings, check the dispenser. Check the correct operating of the input on the card. Inform the painter not to pull the trigger without letting the product flow or change the " Air Gun Trigger" setting. Check the flowmeter. Make sure the gears are turning freely. Check the correct operating of the sensor. Repair or replace.

Default wording	Automatic action	Expected validation	Action following to validation	Trigger	Causes	Remedies
B flow / trigger error	Closing of all valves (CTM, Injection, Gun) Display of the default on the screen	Validation by the user	Swiching to regeneration mode if the machine was in production or restarting priming process if the machine was in the «Priming» phase	The dispenser or the robot sends the open gun information, the injection valve is piloted but the PLC does not receive pulses from the B flowmeter	No supply to the B product Injector blocked Defective injection valve The injection valve does not open Th B flowmeter is blocked or the sensor cable is not correctly connected or the sensor is defective. Pressure delta between A and B insufficient	Check the supply system of the B product (pump, filters, network pressure, color changers). Remove and check the injector. Check that the injection valve is piloted. Replace if necessary. Check the flowmeter. Make sure the gears are turning freely. Check the correct operating of the sensor. Repair or replace. Check the operating pressures and adjsut the pressures.
A solvent flow / Trigger error	Closing of all valves (CTM, Injection, Gun) Display of the default on the screen	Validation by the user	Repeat the flushing cycle	The solvent supply valve is piloted, the open gun input is at 1 but the flowmeter does not send the information	The circuit is blocked. The solvent color changer valve is not open.  The flowmeter is blocked.  The flowmeter does not send the signal. The solvent pressure is too low. The fluid regulator is not piloted or defective.	Check the complete circuit from the supply to the applicator. Check that the output on the card is activated (LED on). Check the air supply to the valve. Check that air is coming from the electrovalve. Check the correct operating of the flowmeter, especially that the gears are turning freely. Check that the sensor and the sensor connector are correctly screwed. Check the supply pressure. Check that the regulator pilot output is piloted. Check the correct operating of the pneumatic cells. Check that the regulator is piloted with air. Check the correct operating of the regulator.

Default wording	Automatic action	Expected validation	Action following to validation	Trigger	Causes	Remedies
A solvent flow / Trigger error	Closing of all valves (CTM, Injection, Gun) Display of the default on the screen	Validation by the user	Repeat the flushing cycle	The solvent supply valve is piloted, the open gun input is at 1 but the flowmeter does not send the information	<p>The circuit is blocked.</p> <p>The solvent color changer valve is not open.</p> <p>The flowmeter is blocked.</p> <p>The flowmeter does not send the signal. The solvent pressure is too low.</p> <p>The fluid regulator is not piloted or defective.</p>	<p>Check the complete circuit from the supply to the applicator. Check that the output on the card is activated (LED on).</p> <p>Check the air supply to the valve.</p> <p>Check that air is coming from the electrovalve.</p> <p>Check the correct operating of the flowmeter, especially that the gears are turning freely.</p> <p>Check that the sensor and the sensor connector are correctly screwed.</p> <p>Check the supply pressure.</p> <p>Check that the regulator pilot output is piloted.</p> <p>Check the correct operating of the pneumatic cells.</p> <p>Check that the regulator is piloted with air.</p> <p>Check the correct operating of the regulator.</p>

Default wording	Automatic action	Expected validation	Action following to validation	Trigger	Causes	Remedies
B solvent flow / Trigger error	Closing of all valves (CTM, Injection, Gun) Display of the default on the screen	Validation by the user	Repeat the flushing cycle	The current flushing cycle corresponds to B solvent but the PLC does not receive pulses from the B flowmeter	The circuit is blocked. The injector is blocked. The electrovalve is defective. The flowmeter is blocked. The flowmeter does not send a signal. The solvent pressure is too low. The fluid regulator is not piloted or is defective.	Check the complete circuit from the supply to the applicator. Check that the injector is not clogged with dried catalyst. Clean or replace if necessary. Check that the electrovalve is properly piloted. Output of the card activated. 24V present. Check the correct operating of the flowmeter, especially that the gears are turning freely. Check that the sensor and the sensor connector are correctly screwed in. Check the supply pressure. Check that the regulator pilot output is piloted. Check the correct operating of the pneumatic cells. Check that the regulator is piloted with air. Check the correct operating of the regulator.
B solvent flow / Trigger error	Display of an alarm message with a banner	NO		Potlife monitoring time has reached the time defined in the "Warning Potlife" parameter	No circulation of the product in the circuits for the time defined in the Warning Potlife parameter	Open the gun (s) to renew the product in the circuit (s) (in production mode).
Warning Potlife	Switching to regeneration or flushing mode depending on the "successive regeneration before flush" parameter and of the "POTLIFE ACHIEVED" information banner	NO		Potlife monitoring time has reached the time defined in the "Potlife" parameter	The "Potlife" time counter has reached the value defined in the "Potlife" parameter	The machine automatically starts a regeneration or a flushing. Make sure that the guns are in the flushboxes if they are present and if not, open the gun(s).



Default wording	Automatic action	Expected validation	Action following to validation	Trigger	Causes	Remedies
Potlife	Switching to regeneration or flushing mode depending on the "successive regeneration before flush" parameter and of the "POTLIFE ACHIEVED" information banner	NO		Potlife monitoring time has reached the time defined in the "Potlife" parameter	The "Potlife" time counter has reached the value defined in the "Potlife" parameter	The machine automatically starts a regeneration or a flushing. Make sure that the guns are in the flushboxes if they are present and if not, open the gun(s).
Injection valve leakage	Closing of all valves (CTM, Injection, Gun) Display of the default on the screen	YES	Switch to regeneration mode and then production	The PLC receives pulses from the B flowmeter without the injection valve being controlled in opening (including a time for pressurization).	Leakage on the A circuit or on the mixed circuit part	Check the circuit (injection block; fittings; valve...). Repair and/or replace the necessary parts. Check the condition of the valve needle. Check the condition of the seat. Check the correct operating of the valve (card output at 0, presence of air in the electrical outlet,...)
A circuit leakage	Display of an alarm message	NO		The machine is in IDLE mode, so no valve is piloted, yet the machine sees pulses on the A flowmeter.	Leakage on the A circuit or on the mixed circuit part	Check the entire circuit.
B circuit leakage	Display of an alarm message	NO		The machine is in IDLE mode, so no valve is piloted, yet the machine sees pulses on the B flowmeter.	Leakage on the catalyst circuit	Check the entire circuit.

## 8. History of revision indexes

Created by:		Verified by	Approved by:
Date	By:	Index	Purpose of the modification and location
03/08/2023	E.DUMONT	A	Creation of the document
09/08/2023	E.DUMONT	B	Document update

## 9. Appendixes

### 9.1. Preventive Maintenance Plan

**PLAN DE MAINTENANCE PREVENTIVE / PREVENTIVE MAINTENANCE PLAN**

Numéro d'ordre Serial	Ensemble - Assembly	Sous ensemble Sub assembly	Désignation de l'élément Designation of the assembly	Pour 1 ensemble - For 1 assembly			Acteurs Métiers Operators - skill (3)				Niveau Level (4)		Manuel d'utilisation Instruction manual	Outil Tool	Document Note	
				Action à effectuer Action to carry out	Temps prévu Estimated Time (1)		Périodicité Periodicity (H / hour) (2)	M	F	E	A	1				2
					100eme H	mn										
<p><b>(1)</b> Temps moyen d'intervention à titre indicatif, et à ajuster par les équipes d'intervention du site / <i>This average intervention time is given for information and should be adjusted by the operating teams on site.</i></p> <p><b>(2)</b> Les périodicités mentionnées sont des moyennes basées sur l'expérience de Sames. A charge des utilisateurs de les adapter aux conditions de leur installation notamment en fonction de la nature des produits utilisés, des vitesses de travail, etc. Sames se réserve le droit de modifier les informations mentionnées dans ce document, sans préavis / <i>The given periodicities are averages based on Sames experience. It is the responsibility of the operators to adapt them to the conditions of their installation, in particular with respect to the nature of the products being used, the work speeds, etc. Sames Kremlin reserves the right to change the information in this document without notice.</i></p> <p><b>(3)</b> M : Mécanicien - F : Spécialiste fluide - E : Electricien - A : Automaticien / <i>M : Mechanic - F : Fluid specialist - E : Electrician - A : Automation specialist</i></p> <p><b>(4)</b> 1 = Niveau de Base, 2 = Niveau Avancé / <i>1 = Basic level, 2 = Advanced level</i></p>																
<p><b>Avant toute intervention, se référer au chapitre sécurité du manuel de l'équipement / Before any intervention, see chapter safety equipment manual</b></p> <p><b>Avant toute intervention sur la pompe, couper l'alimentation en air comprimé et décompresser les circuits / Before working on the pump, shut off the compressed air circuits and decompress</b></p>																
1		Installation complète <i>Complete installation</i>	Etat général <i>Genral statement</i>	Vérifier l'état général de propreté, l'absence de fuite et la bonne fixation de l'équipement. <i>Check the general state of cleanliness, absence of leaks and proper attachment of the equipment.</i>	3,33	2	40		X				1		Avant chaque début de production <i>Before each production start</i>	
2		Filtre <i>Filter</i>	Tamis <i>Screen</i>	Contrôle usure / fuite <i>Wear / Leakage check</i>	3,33	2	40		X				1		Avant chaque début de production <i>Before each production start</i>	
3		Filtre <i>Filter</i>	Tamis <i>Screen</i>	Remplacement <i>Replacement</i>	8,33	5	1000		X				1		Situation du matériel ( Arrêt - Hors production) <i>Equipment status (Shutdown - Out of production)</i>	
4		Filtre <i>Filter</i>	Joints <i>Seals</i>	Remplacement <i>Replacement</i>	3,33	2	2000 (1 fois/an)	X					2		Situation du matériel ( Arrêt - Hors production) <i>Equipment status (Shutdown - Out of production)</i>	
5		Equipement <i>Equipment</i>	Tuyaux et raccords <i>Hoses and fittings</i>	Contrôle usure / fuite <i>Wear / Leakage check</i>	3,33	2	40		X				1			
6		Equipement <i>Equipment</i>	Détendeur d'air de la platine de régulation produit <i>Air regulator on product regulator management plate</i>	Vérification état et bon fonctionnement <i>Checking the state and proper functioning</i>	3,33	2	40	X					1			
7		Equipement <i>Equipment</i>	Manomètre pression d'air de la platine de régulation <i>Air pressure gauge on the pressure regulator management plate</i>	Vérification état et bon fonctionnement <i>Checking the state and proper functioning</i>	3,33	2	40	X					1			
8		Equipement <i>Equipment</i>	Régulateur de peinture <i>Paint regulator</i>	Vérification état et bon fonctionnement <i>Checking the state and proper functioning</i>	3,33	2	40	X					1			
9		Corps de regulateur <i>Body</i>	Membrane air produit <i>Air product diaphragm</i>	Remplacement <i>Replacement</i>	16,67	10	2000 (1 fois/an)	X					2		Situation du matériel ( Arrêt - Hors production) <i>Equipment status (Shutdown - Out of production)</i>	

**PLAN DE MAINTENANCE PREVENTIVE / PREVENTIVE MAINTENANCE PLAN**

Numéro d'ordre Serial	Ensemble - Assembly	Sous ensemble Sub assembly	Désignation de l'élément Designation of the assembly	Pour 1 ensemble - For 1 assembly			Acteurs Métiers Operators - skill (3)				Niveau Level (4)		Manuel d'utilisation Instruction manual	Outil Tool	Document Note	
				Action à effectuer Action to carry out	Temps prévu Estimated Time (1)		Périodicité Periodicity (H / hour) (2)	M	F	E	A	1				2
					100eme H	mn										
10	Système de dosage et mélange Cyclomix® Evo Dosing and mixing system Cyclomix® Evo	Corps de regulateur Body	Siège, ressort et bille Seat spring and ball	Remplacement, changer l'ensemble Replacement, change the assembly	8,33	5	2000 (1 fois/an)	X							Situation du matériel ( Arrêt - Hors production) Equipment status (Shutdown - Out of production)	
11		Equipement Equipment	Manomètre pression peinture Paint regulator	Vérification état et bon fonctionnement Checking the state and proper functioning	3,33	2	40	X				1				
12		Equipement Equipment	Bloc de mélange Mixing block	Vérification état et bon fonctionnement Checking the state and proper functioning	3,33	2	40	X				1				
13		Equipement Equipment	Vanne d'injection Injection valve	Vérification état et bon fonctionnement (fuite) Checking the state and proper functioning (leakage)	3,33	2	40		X			1				Situation du matériel ( En Marche - En Production ) Equipment status (In Operation - In Production)
14		Equipement Equipment	Vanne d'injection Injection valve	Remplacement de la cartouche Replacement of the cartridge	16,67	10	2000 (1 fois/an)	X					2			Situation du matériel ( Arrêt - Hors production) Equipment status (Shutdown - Out of production)
15		Equipement Equipment	Changeurs de teinte Color change valves	Vérification état et bon fonctionnement Checking the state and proper functioning	3,33	2	40	X				1				Situation du matériel ( Arrêt - Hors production) Equipment status (Shutdown - Out of production)
16		Equipement Equipment	Changeurs de teinte Color change valves	Remplacement de la cartouche Replacement of the cartridge	25,00	15	1 fois/an 1 time/year	X					2			Situation du matériel ( Arrêt - Hors production) Equipment status (Shutdown - Out of production)
17		Equipement Equipment	Changeurs de teinte Color change valves	Remplacement du pointeau et de la vanne pneumatique Replacement of the needle and the pneumatic valve	16,67	10	1 fois/an 1 time/year	X				1				Situation du matériel ( Arrêt - Hors production) Equipment status (Shutdown - Out of production)
18		Equipement Equipment	Mélangeur Mixer	Remplacement Replacement	16,67	10	1 fois/an 1 time/year	X					2			Situation du matériel ( Arrêt - Hors production) Equipment status (Shutdown - Out of production)
19		Equipement Equipment	Débitmètres Flowmeters	Nettoyage, vérification état et bon fonctionnement Cleaning, checking the state and proper functioning	33,33	20	1 fois/an 1 time/year		X				2			Situation du matériel ( En Marche - En Production ) Equipment status (In Operation - In Production)
20	Equipement Equipment	Débitmètres Flowmeters	Vérifier la calibration Check the calibration	25,00	15	1000 (2 fois/an)	X					2			Situation du matériel ( En Marche - En Production ) Equipment status (In Operation - In Production)	

**PLAN DE MAINTENANCE PREVENTIVE / PREVENTIVE MAINTENANCE PLAN**

Numéro d'ordre Serial	Ensemble - Assembly	Sous ensemble Sub assembly	Désignation de l'élément Designation of the assembly	Pour 1 ensemble - For 1 assembly			Acteurs Métiers Operators - skill (3)				Niveau Level (4)		Manuel d'utilisation Instruction manual	Outil Tool	Document Note	
				Action à effectuer Action to carry out	Temps prévu Estimated Time (1)		Périodicité Periodicity (H / hour) (2)	M	F	E	A	1				2
					100eme H	mn										
21		Equipement Equipment	Débitmètres Flowmeters	Remplacement Replacement	16,67	10	4000 (1 fois tous les 2 ans)	X				1			Situation du matériel ( Arrêt - Hors production) Equipment status (Shutdown - Out of production)	
22		Equipement Equipment	Platine produit Product platinum	Vérifier qu'il n'y ait pas de fuites au niveau de la platine produit Check for leaks at the product plate.	1,66	1	40	X							Situation du matériel ( Arrêt - Hors production) Equipment status (Shutdown - Out of production)	
23		Equipement Equipment	Circuit d'alimentation Power supply circuit	Contrôler le circuit d'alimentation de toute l'installation. Contrôler la pression d'alimentation, Check the power supply circuit of the entire system. Check the supply pressure.	8,33	5	40	X					2		Situation du matériel ( En Marche - En Production ) Equipment status (In Operation - In Production)	
24		Equipement Equipment	Régulateurs Controllers	Vérifier l'état de la cartouche et du pointeau et de la vanne pneumatique. Changer les joints si nécessaires. Check the condition of the diaphragms. Check the needle seat ball assembly (needle seat ball).	8,33	5	2000 (1 fois/an)	X					2		Situation du matériel ( Arrêt - Hors production) Equipment status (Shutdown - Out of production)	
25		Equipement Equipment	Clapet anti-retour Non-return valve	Vérifier l'état des clapets anti-retour Check the condition of the non-return valves	16,67	10	1000 (2 fois/an)	X					2		Situation du matériel ( En Marche- Hors production) Equipment status ( On - Off production)	
26	COFFRET DE BASE	Equipement Equipment	Coffret de base Main box	Dépoussiérage extérieur et intérieur. Exterior and interior dusting.	1,66	1	2 fois/an 2 times/year			X			2		Situation du matériel ( Arrêt ) Equipment status ( Off )	
27	COFFRET DE BASE	Equipement Equipment	Coffret de base Main box	Contrôle des étanchéités, ventilation, câbles, serrages et connexion. Control of tightness, ventilation, cables, tightening and connection.	16,66	10	2 fois/an 2 times/year			X			2		Avant chaque début de production Before each production start	
28	COFFRET DE BASE	Equipement Equipment	Intérieur coffret Inside the box	Contrôle de l'absence de point chaud par thermographie IR. Control of the absence of hot spots by IR thermography.	16,66	10	4000 (1 fois tous les 2 ans)			X			2		Situation du matériel ( En Marche et En fonction) Equipment status (On and Off)	

**PLAN DE MAINTENANCE PREVENTIVE / PREVENTIVE MAINTENANCE PLAN**

Numéro d'ordre Serial	Ensemble - Assembly	Sous ensemble Sub assembly	Désignation de l'élément Designation of the assembly	Pour 1 ensemble - For 1 assembly			Acteurs Métiers Operators - skill (3)				Niveau Level (4)		Manuel d'utilisation Instruction manual	Outil Tool	Document Note	
				Action à effectuer Action to carry out	Temps prévu Estimated Time (1)		Périodicité Periodicity (H / hour) (2)	M	F	E	A	1				2
					100eme H	mn										
29	COFFRET DE BASE	Equipement Equipment	Intérieur coffret Inside the box	Nettoyage, élimination des câbles inutiles et de tout objet inutile. Remise en place des câbles. <i>Cleaning, removal of unnecessary cables and any unnecessary objects. Repositioning of cables.</i>	8,33	5	2000 (1 fois/an)				X			2	Situation du matériel ( Marche ) Equipment status ( On )	
30	COFFRET DE BASE	Equipement Equipment	Intérieur coffret Inside the box	Contrôle de la présence des schémas électriques à jour. <i>Control of the presence of updated electrical diagrams.</i>	1,66	1	2000 (1 fois/an)				X			2	Situation du matériel ( Marche ) Equipment status ( On )	
31	COFFRET DE BASE	Equipement Equipment	Extérieur de coffret Exterior of the box	Aspect extérieur, contrôle du bon fonctionnement de la serrure, des contacts à clé, des boutons. <i>External appearance, control of the proper functioning of the lock, key contacts, buttons.</i>	8,33	5	2000 (1 fois/an)				X			2	Situation du matériel ( Marche ) Equipment status ( On )	
32	COFFRET MICRO EVO	Equipement Equipment	Coffret Micro Evo Micro Evo box	Dépoussiérage extérieur et intérieur. <i>Exterior and interior dusting.</i>	16,66	10	2000 (1 fois/an)				X			2	Avant chaque début de production Before each production start	
33	COFFRET MICRO EVO	Equipement Equipment	Coffret Micro Evo Micro Evo box	Contrôle des étanchéités, ventilation, câbles, serrages et connexion. <i>Control of tightness, ventilation, cables, tightening and connection.</i>	8,33	5	2000 (1 fois/an)				X			2	Avant chaque début de production Before each production start	
34	COFFRET MICRO EVO	Equipement Equipment	Intérieur coffret Inside the box	Contrôle de l'absence de point chaud par thermographie IR. <i>Control of the absence of hot spots by IR thermography.</i>	16,66	10	4000 (1 fois tous les 2 ans)				X			2	Situation du matériel ( En Marche et En fonction ) Equipment status ( On and Off )	
35	COFFRET MICRO EVO	Equipement Equipment	Intérieur coffret Inside the box	Nettoyage, élimination des câbles inutiles et de tout objet inutile. Remise en place des câbles. <i>Cleaning, removal of unnecessary cables and any unnecessary objects. Repositioning of cables.</i>	8,33	5	2000 (1 fois/an)				X			2	Situation du matériel ( Marche ) Equipment status ( On )	
36	COFFRET MICRO EVO	Equipement Equipment	Intérieur coffret Inside the box	Contrôle de la présence des schémas électriques à jour. <i>Control of the presence of updated electrical diagrams.</i>	1,66	1	2000 (1 fois/an)				X			2	Situation du matériel ( Marche ) Equipment status ( On )	



**PLAN DE MAINTENANCE PREVENTIVE / PREVENTIVE MAINTENANCE PLAN**

Numéro d'ordre Serial	Ensemble - Assembly	Sous ensemble Sub assembly	Désignation de l'élément Designation of the assembly	Pour 1 ensemble - For 1 assembly			Acteurs Métiers Operators - skill (3)				Niveau Level (4)		Manuel d'utilisation Instruction manual	Outil Tool	Document Note	
				Action à effectuer Action to carry out	Temps prévu Estimated Time (1)		Périodicité Periodicity (H / hour) (2)	M	F	E	A	1				2
					100eme H	mn										
37	COFFRET MICRO EVO	Equipement Equipment	Extérieur de coffret Exterior of the box	Aspect extérieur, contrôle du bon fonctionnement de la serrure, des contacts à clé, des boutons. <i>External appearance, control of the proper functioning of the lock, key contacts, buttons.</i>	8,33	5	2000 (1 fois/an)				X			2	Situation du matériel ( Marche ) Equipment status ( On )	
38	COFFRET DEPORTE	Equipement Equipment	Coffret déporté Remote control box	Dépoussiérage extérieur et intérieur. <i>Exterior and interior dusting.</i>	16,66	10	2000 (1 fois/an)				X			2	Situation du matériel ( Arrêt ) Equipment status ( Off )	
39	COFFRET DEPORTE	Equipement Equipment	Coffret déporté Remote control box	Contrôle des étanchéités, ventilation, câbles, serrages et connexion. <i>Control of tightness, ventilation, cables, tightening and connection.</i>	8,33	5	2000 (1 fois/an)				X			2	Avant chaque début de production Before each production start	
40	COFFRET DEPORTE	Equipement Equipment	Intérieur coffret Inside the box	Contrôle de l'absence de point chaud par thermographie IR. <i>Control of the absence of hot spots by IR thermography.</i>	16,66	10	4000 (1 fois tous les 2 ans)				X			2	Situation du matériel ( En Marche et En fonction) Equipment status ( On and Off )	
41	COFFRET DEPORTE	Equipement Equipment	Intérieur coffret Inside the box	Nettoyage, élimination des câbles inutiles et de tout objet inutile. Remise en place des câbles. <i>Cleaning, removal of unnecessary cables and any unnecessary objects. Repositioning of cables.</i>	8,33	5	2000 (1 fois/an)				X			2	Situation du matériel ( Marche ) Equipment status ( On )	
42	COFFRET DEPORTE	Equipement Equipment	Intérieur coffret Inside the box	Contrôle de la présence des schémas électriques à jour. <i>Control of the presence of updated electrical diagrams.</i>	1,66	1	2000 (1 fois/an)				X			2	Situation du matériel ( Marche ) Equipment status ( On )	
43	COFFRET DEPORTE	Equipement Equipment	Extérieur de coffret Exterior of the box	Aspect extérieur, contrôle du bon fonctionnement de la serrure, des contacts à clé, des boutons. <i>External appearance, control of the proper functioning of the lock, key contacts, buttons.</i>	8,33	5	2000 (1 fois/an)				X			2	Situation du matériel ( Marche ) Equipment status ( On )	
44	COFFRET ADDITIONNEL	Equipement Equipment	Coffret additionnel Additional box	Dépoussiérage extérieur et intérieur. <i>Exterior and interior dusting.</i>	16,66	10	2000 (1 fois/an)				X			2	Avant chaque début de production Before each production start	



**PLAN DE MAINTENANCE PREVENTIVE / PREVENTIVE MAINTENANCE PLAN**

Numéro d'ordre Serial	Ensemble - Assembly	Sous ensemble Sub assembly	Désignation de l'élément Designation of the assembly	Pour 1 ensemble - For 1 assembly			Acteurs Métiers Operators - skill (3)				Niveau Level (4)		Manuel d'utilisation Instruction manual	Outil Tool	Document Note	
				Action à effectuer Action to carry out	Temps prévu Estimated Time (1)		Périodicité Periodicity (H / hour) (2)	M	F	E	A	1				2
					100eme H	mn										
45	COFFRET ADDITIONNEL	Equipement Equipment	Coffret additionnel Additional box	Contrôle des étanchéités, ventilation, câbles, serrages et connexion. <i>Control of tightness, ventilation, cables, tightening and connection.</i>	8,33	5	2000 (1 fois/an)			X			2		Avant chaque début de production <i>Before each production start</i>	
46	COFFRET ADDITIONNEL	Equipement Equipment	Intérieur coffret Inside the box	Contrôle de l'absence de point chaud par thermographie IR. <i>Control of the absence of hot spots by IR thermography.</i>	16,66	10	4000 (1 fois tous les 2 ans)			X			2		Situation du matériel ( En Marche et En fonction) <i>Equipment status (On and Off)</i>	
47	COFFRET ADDITIONNEL	Equipement Equipment	Intérieur coffret Inside the box	Nettoyage, élimination des câbles inutiles et de tout objet inutile. Remise en place des câbles. <i>Cleaning, removal of unnecessary cables and any unnecessary objects. Repositioning of cables.</i>	8,33	5	2000 (1 fois/an)			X			2		Situation du matériel ( Marche ) <i>Equipment status ( On )</i>	
48	COFFRET ADDITIONNEL	Equipement Equipment	Intérieur coffret Inside the box	Contrôle de la présence des schémas électriques à jour. <i>Control of the presence of updated electrical diagrams.</i>	1,66	1	2000 (1 fois/an)			X			2		Situation du matériel ( Marche ) <i>Equipment status ( On )</i>	
49	COFFRET ADDITIONNEL	Equipement Equipment	Extérieur de coffret Exterior of the box	Aspect extérieur, contrôle du bon fonctionnement de la serrure, des contacts à clé, des boutons. <i>External appearance, control of the proper functioning of the lock, key contacts, buttons.</i>	8,33	5	2000 (1 fois/an)			X			2		Situation du matériel ( Marche ) <i>Equipment status ( On )</i>	
50	SECTIONNEUR	Composant Component	Sectionneur Disconnecter	Contrôle du fonctionnement du sectionneur. <i>Control of the operation of the disconnecter.</i>	3,33	2	1 fois/an Once a year			X			2		Situation du matériel ( Arrêt ) <i>Equipment status ( Off )</i>	
51	SECTIONNEUR	Composant Component	Sectionneur Disconnecter	Vérification des serrages. <i>Checking of the tightenings.</i>	8,33	5	1 fois/an Once a year			X			2		Situation du matériel ( Arrêt ) <i>Equipment status ( Off )</i>	
52	SECTIONNEUR	Composant Component	Sectionneur Disconnecter	S'assurer que le Label (indications Voltage) est toujours présent sur le coffret. <i>Make sure that the Label (Voltage indications) is always present on the box.</i>	1,66	1	1 fois/an Once a year			X			2		Situation du matériel ( Arrêt ) <i>Equipment status ( Off )</i>	
53	Relais	Composant Component	Relais Relay	Contrôle de la valeur de réglage <i>Control of the set value</i>	3,33	2	1 fois/an Once a year			X			2		Situation du matériel ( Marche ) <i>Equipment status ( On )</i>	

**PLAN DE MAINTENANCE PREVENTIVE / PREVENTIVE MAINTENANCE PLAN**

Numéro d'ordre Serial	Ensemble - Assembly	Sous ensemble Sub assembly	Désignation de l'élément Designation of the assembly	Pour 1 ensemble - For 1 assembly			Acteurs Métiers Operators - skill (3)				Niveau Level (4)		Manuel d'utilisation Instruction manual	Outil Tool	Document Note	
				Action à effectuer Action to carry out	Temps prévu Estimated Time (1)		Périodicité Periodicity (H / hour) (2)	M	F	E	A	1				2
					100eme H	mn										
54	Relais	Composant Component	Relais Relay	Vérification des serrages. <i>Checking of the tightenings.</i>	1,66	1	1 fois/an Once a year			X					Situation du matériel ( Arrêt ) <i>Equipment status ( Off )</i>	
55	Cartes Entrées /Sorties	Composant Component	Cartes Entrées/Sorties Input/Output cards	Contrôler les éléments de la boucle d'automatisme et l'état physique des capteurs. <i>Check the elements of the automation loop and the physical state of the sensors.</i>	8,33	5	1 fois/an Once a year				X	1			Avant chaque début de production <i>Before each production start</i>	
56	SUPERVISIONS ET COMMANDES NUMERIQUES	Composant Component	Carte d'interface Interface board	Contrôler les éléments de la boucle d'automatisme. L'intégrité de la chaîne de mesure et l'état physique des capteurs. <i>Check the elements of the automation loop. The integrity of the measurement chain and the physical state of the sensors.</i>	8,33	5	4 fois/an 4 times/year				X	1			Situation du matériel ( Arrêt ) <i>Equipment status ( Off )</i>	
57	SUPERVISIONS ET COMMANDES NUMERIQUES	Composant Component	Clé USB USB key	Assurer une sauvegarde automatique doublée, voire triplée. <i>Ensure automatic backup doubled, tripled.</i>	16,66	10	1 fois/an ou selon KM/0 Première mise en service <i>1 time/year or according to KM/0 First commissionin g</i>				X		2		Situation du matériel ( Marche ) 1 fois/an ou selon KM/0 Première mise en service <i>Equipment status ( On ) 1 time/year or according to KM/0 First commissioning</i>	
58	SUPERVISIONS ET COMMANDES NUMERIQUES	Composant Component	Configuration et Stockage Configuration and Storage	Télécharger et stocker la configuration système via une clé USB. <i>Download and store the system configuration via a USB stick.</i>	16,66	5	1 fois/an ou selon KM/0 Première mise en service <i>1 time/year or according to KM/0 First commissionin g</i>				X		2		Situation du matériel ( Marche ) 1 fois/an ou selon KM/0 Première mise en service <i>Equipment status ( On ) 1 time/year or according to KM/0 First commissioning</i>	
59	SUPERVISIONS ET COMMANDES NUMERIQUES	Composant Component	Câblages Wirings	Contrôler l'état des câbles d'alimentation et des prises de terre. <i>Check the condition of the power cables and ground connections.</i>	3,33	2	150 ou Mensuel <i>150 or Monthly</i>			X			2		Situation du matériel ( Marche ) <i>Equipment status ( On )</i>	

**PLAN DE MAINTENANCE PREVENTIVE / PREVENTIVE MAINTENANCE PLAN**

Numéro d'ordre Serial	Ensemble - Assembly	Sous ensemble Sub assembly	Désignation de l'élément Designation of the assembly	Pour 1 ensemble - For 1 assembly			Acteurs Métiers Operators - skill (3)				Niveau Level (4)		Manuel d'utilisation Instruction manual	Outil Tool	Document Note	
				Action à effectuer Action to carry out	Temps prévu Estimated Time (1)		Périodicité Periodicity (H / hour) (2)	M	F	E	A	1				2
					100eme H	mn										
60	CAPTEURS - DETECTEURS	Composant Component	Capteurs - détecteurs Sensors	Netoyage du capteur, contrôle du câble à l'entrée de la connexion, Checking availability of spare parts	8,33	5	40			X					Situation du matériel ( Arrêt ) Equipment status ( Off )	
61	CHAINE DE MESURE	Composant Component	Capteurs - détecteurs Sensors	Contrôle de l'ensemble de la chaîne de mesure, du capteur à l'E/S de l'automate, absence de frottement, longueur suffisante, connecteurs en état, Control of the whole measurement chain, from the sensor to the I/O of the PLC, absence of friction, sufficient length, connectors in good condition,	16,66	10	2 fois/an Twice a year			X	X				Situation du matériel ( Marche ) Equipment status ( On )	
62	REGULATEUR (FLUID REGULATOR BASE)	Composant Component	Régulateur Regulator	Dépoussiérer l'électronique, contrôler le raccordement Dust the electronics, check the connection.	16,66	10	1 fois/an Once a year			X					Situation du matériel ( Arrêt ) Equipment status ( Off )	
63	DALLE LEXAN TACTILE	Composant Component	Dalle Lexan tactile Touch-sensitive Lexan panel	Tester la tactilité de l'écran IHM. Test the tactility of the HMI screen.	8,33	5	2 fois/an Twice a year				X	1			Situation du matériel ( En Marche et En fonction ) Equipment status ( On and Off )	
64	PRISE DE COURANT	Composant Component	Prise de courant Power outlet	Vérification de l'état de la prise (plots, isolants, protection, visserie) Checking the condition of the socket (studs, insulation, protection, screws)	3,33	2	1 fois/an Once a year			X					Situation du matériel ( Arrêt ) Equipment status ( Off )	
65	CABLE D'ALIMENTATION ELECTRIQUE	Composant Component	Câble d'alimentation électrique Power supply cable	Vérification de l'état du câble (isolant et mécanique), Checking the condition of the cable (insulation and mechanical)	1,66	1	1 fois/an Once a year			X					Situation du matériel ( Marche ) Equipment status ( On )	
66	ALARME SONORE ET VISUEL	Composant Component	Alarme sonore et visuel Sound and visual alarm	Contrôle du fonctionnement par simulation à partir du poste électrique, Functional control by simulation from the electrical station	8,33	5	1 fois/an Once a year			X					Situation du matériel ( Marche ) Equipment status ( On )	
67	Pièces de rechange Spare parts	Stock Stock	Pièces Spare parts	Vérification disponibilité des pièces de première urgence Checking availability of spare parts	8,33	5	2 fois/an Twice a year	X	X			1	2			

## 9.2. EU declaration of conformity and UKCA declaration



DECLARATION OF INCORPORATION  
OF PARTLY COMPLETED MACHINERY  
EU DECLARATION OF CONFORMITY

(1) The manufacturer declares herewith declares that the equipment is in conformity with the relevant Union harmonization legislation.

(2) <b>Equipment type</b>	Electronic Dosing System Cyclomix® Evo																			
(3) <b>Applicable Directives</b>	2006/42/CE	(4) <b>The relevant technical documentation was compiled as specified in annex VII, part B.</b>																		
		The essential health and safety requirements mentioned in the Directive 2006/42/CE on Machinery have been applied. Articles: 1.1.5 ,1.1.6, 1.3.1, 1.3.2, 1.3.4, 1.5.1, 1.5.2																		
	(5) <b>That partly completed machinery is also in conformity with the provisions of</b>																			
	2014/34/UE	(6) <b>Marking</b>	Electronic Dosing System II 2G Ex h IIB T4 Gb X => dosing system in ATEX Zone II (2)G Ex[ia Gb] IIB => piloting box outside of ATEX zone																	
			<table border="1"> <thead> <tr> <th>Equipment</th> <th>Approval N°</th> </tr> </thead> <tbody> <tr> <td>Zener barrier</td> <td>BAS 01 ATEX 7005</td> </tr> <tr> <td>Electrovalve ATEX</td> <td>LCIE 12 ATEX 3005 X</td> </tr> <tr> <td>Sensor element ATEX</td> <td>BVS 08 ATEX E 101</td> </tr> <tr> <td>Mass Flowmeter</td> <td>BVS 17 ATEX E 074</td> </tr> <tr> <td>Cylinder</td> <td>21 ATEX 0036</td> </tr> <tr> <td>Pressure sensor</td> <td>SEV 11 ATEX 0129</td> </tr> <tr> <td>Fiber optic amplifier sensor</td> <td>BVS 17 ATEX E 041</td> </tr> </tbody> </table>		Equipment	Approval N°	Zener barrier	BAS 01 ATEX 7005	Electrovalve ATEX	LCIE 12 ATEX 3005 X	Sensor element ATEX	BVS 08 ATEX E 101	Mass Flowmeter	BVS 17 ATEX E 074	Cylinder	21 ATEX 0036	Pressure sensor	SEV 11 ATEX 0129	Fiber optic amplifier sensor	BVS 17 ATEX E 041
			Equipment	Approval N°																
			Zener barrier	BAS 01 ATEX 7005																
			Electrovalve ATEX	LCIE 12 ATEX 3005 X																
Sensor element ATEX	BVS 08 ATEX E 101																			
Mass Flowmeter	BVS 17 ATEX E 074																			
Cylinder	21 ATEX 0036																			
Pressure sensor	SEV 11 ATEX 0129																			
Fiber optic amplifier sensor	BVS 17 ATEX E 041																			
Each individual electrical component used in zone 1 is in conformity with the 2014/34/UE directive. Their combined presence in the assembly hasnohighlighted any additional risks that would necessitate a comprehensive assesment of this type of machinery.																				
(7) <b>Harmonised standards</b>																				
(8) <b>Conformity assessment procedure</b>																				
2014/30/UE	Electromagnetic Compatibility Directive																			
2014/35/UE	Low Voltage Directive																			
2012/19/UE	Waste Electrical and Electronic Equipment (WEEE)																			
(9) <b>Notified body</b>	INERIS 0080 – 60550 Verneuil-en-Halatte – France – INERIS-EQEN / n° INERIS-CERN 038002/ 22.																			
<p>(10) <b>This partly completed machinery must not be put into service until the final machinery in which it is to be incorporated has been declared in conformity with Directive 2006/42/CE on Machinery.</b></p> <p><b>Sames is allowed to compil the technical documentation.</b></p> <p><b>Sames undertakes to transmit, in response to a reasoned request by the national authorities, relevant information on the partly completed machinery in the most appropriate form. This declaration of incorporation of partly completed machinery and this declaration of conformity are issued under the sole responsibility of the manufacturer.</b></p>																				

Director of the STAINS site - Executive Management (EM)

Hervé WALTER

Established in Stains, on 25-nov.-22 | 08:19 CET

DocuSigned by:

*Hervé WALTER*

361F833E514C4D1...

Sames

Siège Social / Headquarter: 13, chemin de Malacher - CS70086 - 38243 Meylan Cedex - France - Tél / Phone: +33 (0)4 76 41 60 60

SAS au capital de 12.720.000 euros | RCS Grenoble: 572 051 688 | Code APE: 2829B | TVA intracom: FR36 572051688







DECLARATION OF INCORPORATION  
OF PARTLY COMPLETED MACHINERY  
EU DECLARATION OF CONFORMITY

**(1) The manufacturer declares herewith declares that the equipment is in conformity with the relevant Union harmonization legislation.**

<b>(2) Equipment type</b>	Electronic Dosing System Cyclomix® Evo	
<b>(3) Applicable Directives</b>	2006/42/CE	<b>(4) The relevant technical documentation was compiled as specified in annex VII, part B.</b>
		The essential health and safety requirements mentioned in the Directive 2006/42/CE on Machinery have been applied. Articles: 1.1.5 ,1.1.6, 1.3.1, 1.3.2, 1.3.4, 1.5.1, 1.5.2
	<b>(5) That partly completed machinery is also in conformity with the provisions of</b>	
	2014/30/UE	Electromagnetic Compatibility Directive
	2014/35/UE	Low Voltage Directive
2012/19/UE	Waste Electrical and Electronic Equipment (WEEE)	
<b>(6) Notified body</b>	INERIS 0080 – 60550 Verneuil-en-Halatte – France – INERIS-EQEN	
<p><b>(7) This partly completed machinery must not be put into service until the final machinery in which it is to be incorporated has been declared in conformity with Directive 2006/42/CE on Machinery.</b></p> <p><b>Sames is allowed to compile the technical documentation.</b></p> <p><b>Sames undertakes to transmit, in response to a reasoned request by the national authorities, relevant information on the partly completed machinery in the most appropriate form. This declaration of incorporation of partly completed machinery and this declaration of conformity are issued under the sole responsibility of the manufacturer.</b></p>		

**Director of the STAINS site - Executive Management (EM)**

Hervé WALTER

Established in Stains, on 25-nov.-22 | 08:21 CET

DocuSigned by:

*Hervé WALTER*

361F833E514C4D1...







DECLARATION OF INCORPORATION  
OF PARTLY COMPLETED MACHINERY  
UK DECLARATION OF CONFORMITY

**(1) The manufacturer herewith declares that the equipment is in conformity with the UK statutory requirements.**

<b>(2) Equipment type</b>	Electronic Dosing System Cyclomix® Evo																		
<b>(3) Applicable Directives</b>	2008 No. 1597	<b>(4) The relevant technical documentation was compiled as specified in annex VII, part B.</b>																	
	The essential health and safety requirements mentioned in Supply of Machinery (Safety) Regulations 2008 have been applied. Articles: 1.1.5 ,1.1.6, 1.3.1, 1.3.2, 1.3.4, 1.5.1, 1.5.2																		
	<b>(5) That partly completed machinery is also in conformity with the provisions of</b>																		
	2016 No. 1107	<b>(6) Marking</b>	Electronic Dosing System ⊕ II 2G Ex h IIB T4 Gb X => dosing system in ATEX Zone ⊕ II (2)G Ex[ia Gb] IIB => piloting box outside of ATEX zone																
	<table border="1"> <thead> <tr> <th>Equipment</th> <th>Approval N°</th> </tr> </thead> <tbody> <tr> <td>Zener barrier</td> <td>BAS 01 ATEX 7005</td> </tr> <tr> <td>Electrovalve ATEX</td> <td>LCIE 12 ATEX 3005 X</td> </tr> <tr> <td>Sensor element ATEX</td> <td>BVS 08 ATEX E 101</td> </tr> <tr> <td>Mass Flowmeter</td> <td>BVS 17 ATEX E 074</td> </tr> <tr> <td>Cylinder</td> <td>21 ATEX 0036</td> </tr> <tr> <td>Pressure sensor</td> <td>SEV 11 ATEX 0129</td> </tr> <tr> <td>Fiber optic amplifier sensor</td> <td>BVS 17 ATEX E 041</td> </tr> </tbody> </table>		Equipment	Approval N°	Zener barrier	BAS 01 ATEX 7005	Electrovalve ATEX	LCIE 12 ATEX 3005 X	Sensor element ATEX	BVS 08 ATEX E 101	Mass Flowmeter	BVS 17 ATEX E 074	Cylinder	21 ATEX 0036	Pressure sensor	SEV 11 ATEX 0129	Fiber optic amplifier sensor	BVS 17 ATEX E 041	
	Equipment		Approval N°																
	Zener barrier		BAS 01 ATEX 7005																
Electrovalve ATEX	LCIE 12 ATEX 3005 X																		
Sensor element ATEX	BVS 08 ATEX E 101																		
Mass Flowmeter	BVS 17 ATEX E 074																		
Cylinder	21 ATEX 0036																		
Pressure sensor	SEV 11 ATEX 0129																		
Fiber optic amplifier sensor	BVS 17 ATEX E 041																		
Each individual electrical component used in zone 1 is in conformity with the 2016 No. 1107 directive. Their combined presence in the assembly has not highlighted any additional risks that would necessitate a comprehensive assessment of this type of machinery.																			
<b>(7) Designated standards</b> EN ISO 80079-36 : 2016 EN ISO 80079-37 : 2016 EN 1127-1 : 2019																			
<b>(8) Conformity assessment procedure</b> Module A Technical documentation (Annex VIII)																			
2016 No. 1091	The Electromagnetic Compatibility Regulations 2016																		
2016 No. 1101	Low Voltage Directive																		
2013 No. 3113	Waste Electric and Electronic Equipment (WEEE) Regulations 2013																		
<b>(9) Approved body</b>	Approved Bodies INERIS 0080 – 60550 Verneuil-en-Halatte- France / n° INERIS-CERN 038002/ 22. 21CLM 25031 - Ellesmere Port - United Kingdom / CML n°22UKEXT747 Issue 0																		
<b>(10) This partly completed machinery must not be put into service until the final machinery in which it is to be incorporated has been declared in conformity with Supply of Machinery (Safety) Regulations 2008. SAMES KREMLIN is allowed to compile the technical documentation. SAMES KREMLIN undertakes to transmit, in response to a reasoned request by the national authorities, relevant information on the partly completed machinery in the most appropriate form. This declaration of incorporation of partly completed machinery and this declaration of conformity are issued under the sole responsibility of the manufacturer.</b>																			

Director of the STAINS site - Executive Management (EM)

Hervé WALTER

Established in Stains, on 16-déc.-22 | 19:27 CET

DocuSigned by:

Hervé WALTER

361F833E514C4D1...

SAMES

Siège Social / Headquarter: 13, chemin de Malacher - CS70086 - 38243 Meylan Cedex - France - Tél / Phone: +33 (0)4 76 41 60 60

SAS au capital de 12.720.000 euros | RCS Grenoble: 572 051 688 | Code APE: 2829B | TVA intracom: FR36 572051688



Table with 2 columns: Numbered rows (1-10) and corresponding text in multiple languages (French, Spanish, Italian, Greek, etc.) describing technical specifications and compliance requirements.

Sames

Siège Social / Headquarter: 13, chemin de Malcher - CS70086 - 38243 Meylan Cedex - France - Tél / Phone: +33 (0)4 76 41 60 60

SAS au capital de 12.720.000 euros | RCS Grenoble: 572 051 688 | Code APE: 2829B | TVA intracom: FR36 572051688



DECLARATION OF INCORPORATION  
OF PARTLY COMPLETED MACHINERY  
UK DECLARATION OF CONFORMITY

**(1) The manufacturer herewith declares that the equipment is in conformity with the UK statutory requirements.**

<b>(2) Equipment type</b>	Electronic Dosing System Cyclomix® Evo	
<b>(3) Applicable Directives</b>		<b>(4) The relevant technical documentation was compiled as specified in annex VII, part B.</b>
	2008 No. 1597	The essential health and safety requirements mentioned in Supply of Machinery (Safety) Regulations 2008 have been applied. Articles: 1.1.5 ,1.1.6, 1.3.1, 1.3.2, 1.3.4, 1.5.1, 1.5.2
		<b>(5) That partly completed machinery is also in conformity with the provisions of</b>
	2016 No. 1091	The Electromagnetic Compatibility Regulations 2016
	2016 No. 1101	Low Voltage Directive
	2013 No. 3113	Waste Electric and Electronic Equipment (WEEE) Regulations 2013
<b>(6) Approved body</b>	Approved Bodies INERIS 0080 – 60550 Verneuil-en-Halatte- France / no INERIS- CERN 036593 / 21CLM 25031 - Ellesmere Port - United Kingdom / CML n°	
<b>(7) This partly completed machinery must not be put into service until the final machinery in which it is to be incorporated has been declared in conformity with Supply of Machinery (Safety) Regulations 2008. SAMES KREMLIN is allowed to compile the technical documentation. SAMES KREMLIN undertakes to transmit, in response to a reasoned request by the national authorities, relevant information on the partly completed machinery in the most appropriate form. This declaration of incorporation of partly completed machinery and this declaration of conformity are issued under the sole responsibility of the manufacturer.</b>		

Director of the STAINS site - Executive Management (EM)

Hervé WALTER

Established in Stains, on 25-nov.-22 | 08:21 CET

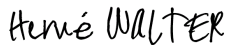
DocuSigned by:  
  
 361F833E514C4D1...





For almost a century, **Sames** has provided services and equipment for the application of liquid and powder paints, adhesives and sealants to bond, protect and beautify all types of surfaces.

We design, produce and market complete solutions - manual guns, automatic and robotic applicators, pumps and dosing machines...

We offer solutions at the cutting edge of technological innovation, serving industrial efficiency for the most challenging customers, and environmentally friendly.

**Sames** bonds, protects and beautifies all materials.

More than a supplier, **Sames** is the partner of your performance.

**We *Simply Apply the Most Efficient Solutions.***

Enjoy being the best *together*



Headquarter: 13, Chemin de Malacher - CS70086 - 38243 Meylan Cedex - France  
☎ +33 (0)4 76 41 60 60 - [www:sames.com](http://www:sames.com)