

SAMES KREMLIN



Electrostatic Powder Coating



Catalogue v2.0

“Powder coating solutions for the highest Productivity since 1960”

Apply your Skills

www.sames-kremlin.com



SAMES KREMLIN - HEADQUARTER - 13 CHEMIN DE MALACHER - 38243 MEYLAN
≈ 236 EMPLOYEES / 15 000 M²



SAMES KREMLIN - 150, AVENUE DE STALINGRAD - 93240 STAINS
≈ 220 EMPLOYEES / 20 000 M²

Editor's note



To help you increase your competitiveness, **SAMES KREMLIN** dedicates itself daily to excellence in terms of innovation and reliability.

We are constantly improving our performances as well as quality to meet your specific needs.

We also help you define the equipment allowing your installation to comply with V.O.C. directives and industry standards.

We enable you to benefit from reliable technologies while ensuring you a swift return on investment.

In this catalog, you will find the equipment that will enable you to reach the paint application results you are targeting and the finish quality you desire.

Our mission is to provide you with the best equipment to meet your needs and requirements.

The entire team at **SAMES KREMLIN** is at your disposal to answer your questions.

Enjoy your reading.

Table of contents

POWDER KNOW-HOW	4	RANGE OF POWDER EQUIPMENT	12
		INDEX	68

PRODUCTS RANGE

MANUAL GUN	14	CONTROL SYSTEMS	38
Inogun M	14	Inorecip	38
MANUAL APPLICATION SYSTEMS	18	Inoprofile	40
Inocart VT	20	Inomaster	42
Inocart H	22	FEEDING & PREPERATION	44
Inocart HF	24	CS130	44
Inocart NDT	24	Inotransfer	46
AUTOMATIC APPLICATION SYSTEMS	26	Inotank	48
Inogun A	28	Inosieve	48
Inogun A FCC	28	Vibrating table	48
Inobell	30	POWDER SYSTEMS	50
ROBOTIC APPLICATION SYSTEMS	34	Engineering solutions	50
Inogun R / RC / RD	34	Inoboath	60
Inobell R	36	PVV EasyCompact	61
		PVV EasyColor	62
		TOOLS & ACCESSORIES	64
		HVP500	64
		AS100	65
		Operators accessories	66

SYMBOLS



Corona application



Rotating bell application

A strong identity at your disposal

In over 70 years of experiences, **SAMES KREMLIN** has built up a unique know-how in many different fields of activity.

Numerous installations such as car manufacturing, tier 1&2 and many other industrials markets are equipped with our electrostatic solutions.

This know-how is for you the guarantee that we are experienced team members, able to understand your needs and to speak the same language.

It is also the guarantee for you to work with technicians that are able to lead you towards the best technical alternative and to offer you a reliable solution.

You surely can rely on **SAMES KREMLIN** to enable you to reach your efficiency goals in a sustainable manner.

Improving your competitiveness and making your investments cost-effective is our commitment.

“ Our strength: a real and strong collaboration with our worldwide customers, to answer various and complex requirements.

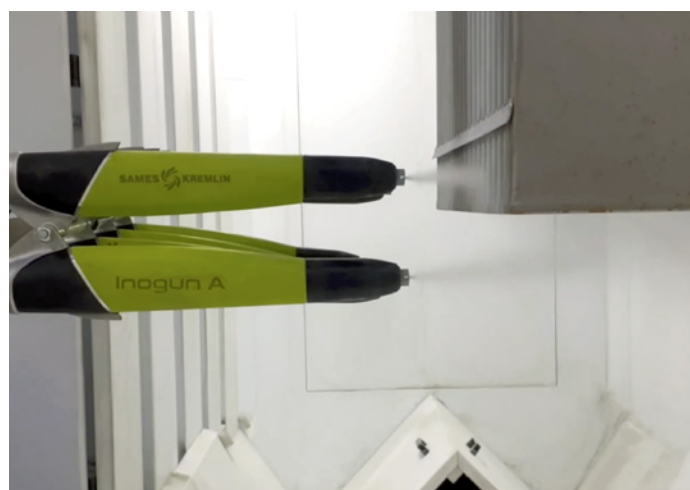

SAMES KREMLIN is the only world-class powder electrostatic equipment manufacturer offering the whole range of solutions such as:

➤ Premium Quality

➤ Competitivity

High Transfer Efficiency,
Productivity increase,
Reduced maintenance operations
Reliability,
TCO⁽¹⁾ reduced

➤ Any Process

Manual solutions
Automatic solutions
Fast color changing solutions
Robotic solutions
Engineering customized solutions for both

Improve your business

Leader in finishing solutions to protect and embellish materials, **SAMES KREMLIN** is your key partner to enhance your productivity, combined with an excellent finish quality.



**THE MOST ADVANCED
TECHNOLOGIES**

**INNOVATIVE
TURN-KEY OFFER**

**ENGAGED
BEYOND YOUR NEEDS**

R & D = 48 people
(20% of the workforce)

Over 60 active patents

Electrostatic expertise
Finishing Science
Powder coating inventor

Key technical areas controlled

- Finishing,
- Robotics,
- Mechanical,
- Automation,
- Fluid,
- Electrical, Electronics...

Engineering =
200 people worldwide

Analyze and anticipate your needs

A global network of experts, close to you

Support you

- Culture of industrial and technical cooperation
- Services during the life of your installation

Our commitments

Customer satisfaction through clear processes

Customer satisfaction

SAMES KREMLIN HAS WORKED OUT A COMPLETE OFFER OF SERVICES, ADAPTED TO ALL YOUR NEEDS:

Advice, repair, servicing, adjustment or intervention by a qualified technician. Whatever your request may be, **SAMES KREMLIN** Customer satisfaction department, is at your disposal to answer your needs within the shortest time.



> HOTLINE



SAMES KREMLIN has a quality hotline which takes care of our customer satisfaction. Please fill free to contact us. Our customer service team would like to provide an answer under 48 hours.

+33 (0)1 49 40 25 28

Monday to Friday: 8:30 - 12:00 am & 13:00 - 17:30 pm

> AUDIT



In order to make the most from your installation, paint or powder, advice and expertise of specialists are essential. Made of practical, experienced members, **SAMES KREMLIN** customer support team will carry out a diagnostic of your installation and will provide you with a worthy technical assistance for the improvement or retrofit of your paint line.

> REPAIR



A regular, and carried out professionally, maintenance or a retrofit of your equipment, is the best way to guaranty the correct running of your equipment. To this end, do not hesitate to contact one of our technicians:

- to get technical advice or technical assistance by phone
- to get one of your product repaired or controlled
- to carry out a retrofit

> SPARE PARTS



Original spare parts guaranty the correct running of your equipment. We are here to deal with all your orders of spare parts throughout the world. Thus, our aim is to rapidly supply you and at the best price, with the wished part in order to guaranty an optimum and prolonged running of your paint or powder application equipment.

> TRAINING



SAMES KREMLIN is registered as a training centre by the French Ministry of Employment. Training sessions that allow you learning the requisite knowledge to the use and the maintenance of your equipment are organised throughout the year. A catalogue can be obtained upon request. You will be then able to choose among the proposed selection of training courses, the type of training that meets your needs or production aims. These training sessions can be organised within your premises or in our training centre located in our headquarters in Meylan - FRANCE.



Quality assurance

In conformity with the ISO9001 standard - issue 2008, the requisite procedures and registrations are mastered. The seriousness with which **SAMES KREMLIN**'s quality policy is dealt ensures you an optimum quality at each stage of the production and of the assembly of the components.

Our products are in the scope of the following European directives:

- 2014/34/UE Explosive Atmospheres
- 2006/42/CE Machinery
- 2014/35/UE Low Voltage
- 2014/30/UE Electromagnetic Compatibility
- 2011/65/UE RoHS Restriction of Hazardous Substances in electrical and electronic equipment
- 2012/19/UE WEEE Waste of Electrical and Electronic Equipment
- 1907/2006/CE REACH Registration, Evaluation, Authorization and Restriction of Chemicals.

A process mapping allows organizing all the stages while being very attentive to the various environments (customers, competition...), to the audits (inner and outer) and to the indicators linked to the defined aims.

PROCESSES MAPPING

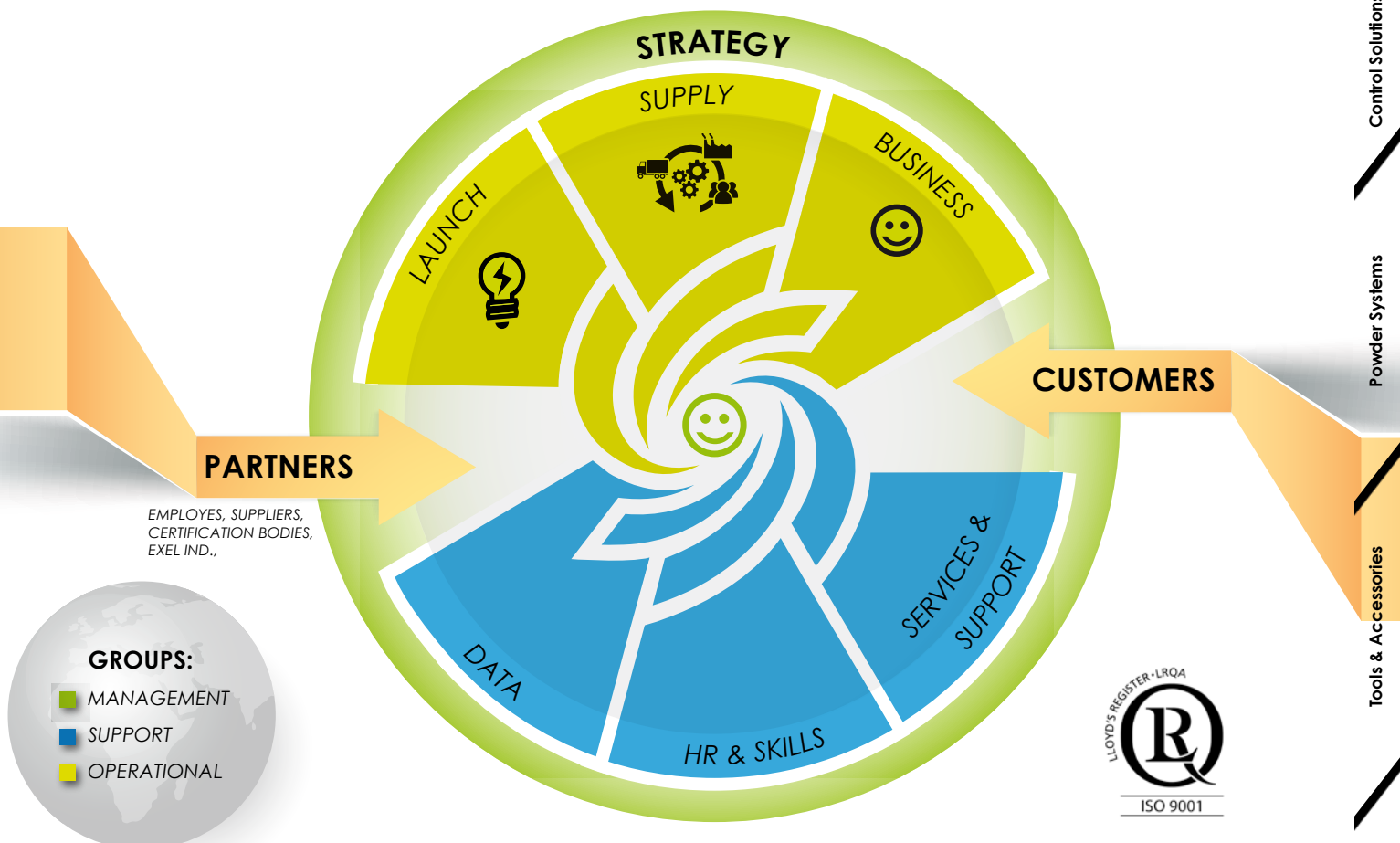



Powder solutions

Whichever your process may be, there is always a well proven painting solution to carry out your application:

- Manual
- Automatic
- Robotic
- Quick color change

In close collaboration with our technical teams, a solution will be worked out to meet your requirements; our range allowing equipping any type of facility.

Research & Innovation

SAMES KREMLIN' main activity is to increase the productivity of its customers by designing and manufacturing innovative electrostatic systems. Launching new products into the market is the core of our organization.

Our know-how, our large investment in Research & Development as well as our reliability-proven equipment allow us proposing our customers integrated robotic solutions.

SAMES KREMLIN has been integrating its own technology for decades all around the world. Your efficiency is leading our solutions:

- **Improve excellent finishing quality:**
 - provides uniform film build
 - provides repeatable even coating thickness
- **Increase transfer efficiency:**
 - saves on powder
 - reduces booth residues
- **Provide superior wrap:**
 - reduces application time
 - reduces the number of applicators required
- **Reduce the operating costs of coating and increase production capacity**



POWDER PAINT SOLUTIONS

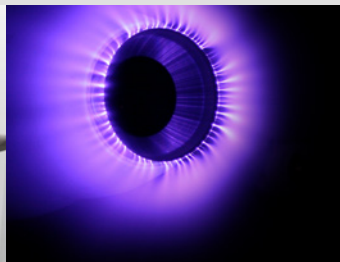

RESEARCH & INNOVATION



ENGINEERING PARTNERSHIP



CUSTOMER SERVICE

Engineering partnership

The **SAMES KREMLIN** engineering teams share with our customers the fruit of their experience and bring all of their expertise and availability. Each of our customers is guaranteed technical and commercial tracking in the running and development of their coating process, our staff are always available to provide rapid assistance and advice.

SAMES KREMLIN commits to the quality and reliability of its solutions and services, such as the improvement of:

- The performance (regularity and transfer rates of the equipment, output when changing colours, etc...)

- Compliance with safety and environmental rules
- Productivity (grouped colour batches, unhooking of hangers, etc...)
- Reduction of costs
- Automation of functions (detection of size, break between parts, automatic cleaning of applicators, proportional flow control, use of spray gun recipes dedicated to families of products, etc...)
- Ergonomics of work stations
- Tracking and management of maintenance

Global presence

16 Locations



 : Application center
 ● : Office

USA



SAMES KREMLIN 
 Application Lab
 45001 5 Mile Rd.
 PLYMOUTH, MI, 48170
 Ph: +1 734 979 0100

CANADA

SAMES KREMLIN
 931, Progress Ave, Unit 7
 SCARBOROUGH M1G 3V5
 Ph: +1 800 450 0655

MEXICO

SAMES KREMLIN
 BERNARDO GARZA TREVINO # 1715
 COL DE MAESTRO MONTERREY, N.L
 CP 64180 MEXICO
 Ph: +52 (442) 161 2595

BRAZIL

SAMES KREMLIN
 Rua Alfredo Mario Pizotti, N.41
 Vila Guilherme
 SAO PAULO SP
 Ph: +55 (11) 2903 1200

ARGENTINA

SAMES KREMLIN
 Avenida Juan Justo, 6021
 C1416DLB CIUDAD DE BUENOS AIRES
 Ph: +54 11 45 82 89 80

FRANCE

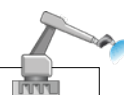

SAMES KREMLIN 
 Headquarter
 Application Lab
 13 chemin de Malacher
 38243 MEYLAN Cedex - France
 Ph: +33 (0)4 76 41 60 60

FRANCE

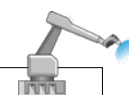

SAMES KREMLIN 
 Application Lab
 150, av. de Stalingrad
 93245 STAINS Cedex - France
 Ph: +33 (0)1 49 40 25 25

GERMANY

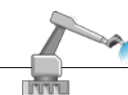

SAMES KREMLIN GmbH 
INTEC SAMES KREMLIN GmbH 
 High viscosity application Lab
 Otto - Hahn - Allee 9
 50374 Erftstadt - Germany
 Ph: +49 (0)2235 46558 - 0 (INTEC)
 Ph: +49 (0)2235 46558 - 220 (SAMES KREMLIN)

Global presence

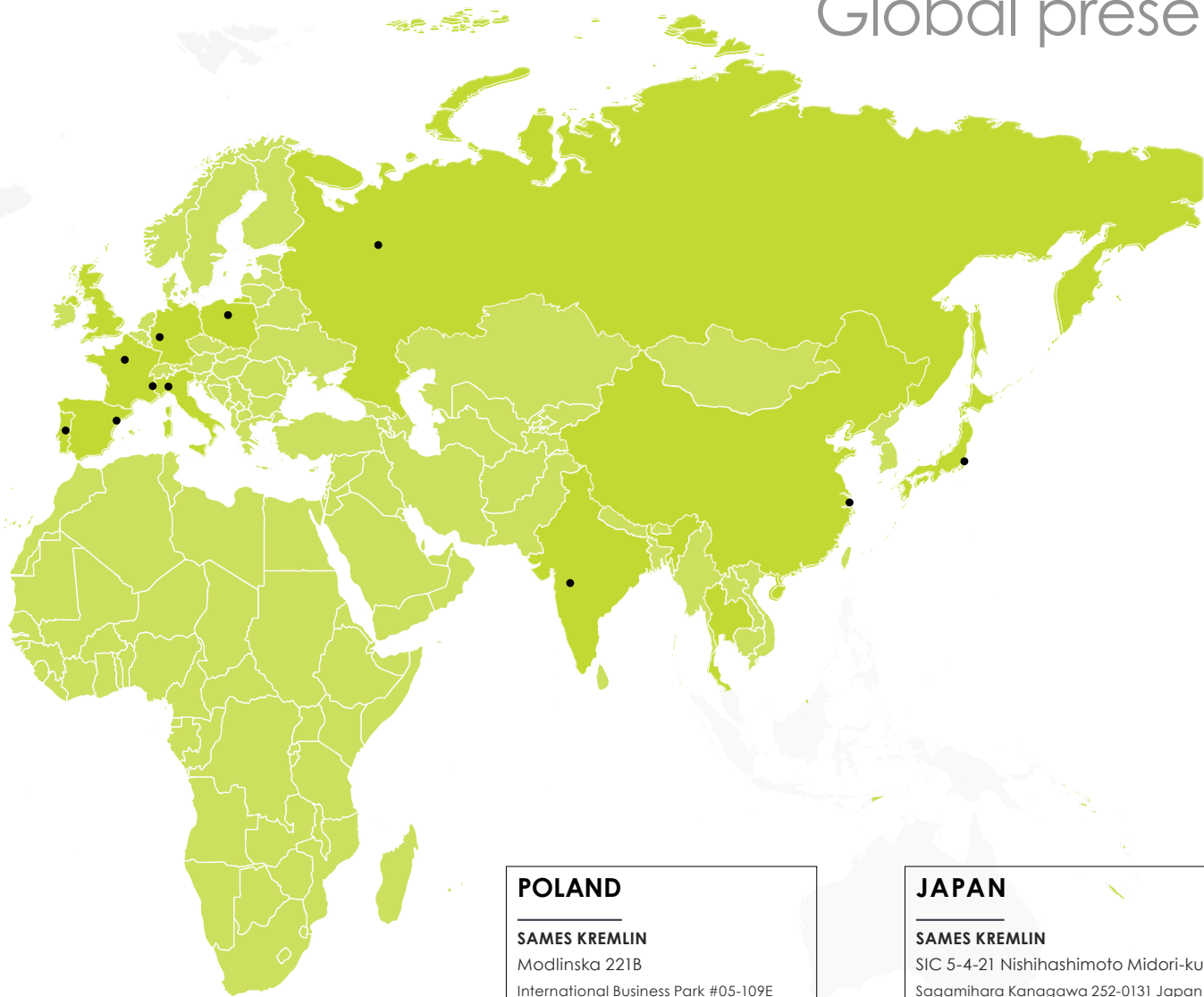

POLAND

SAMES KREMLIN
 Modlinska 221B
 International Business Park #05-109E
 03120-WARSZAWA
 Ph: +48 225 10 38 50

JAPAN

SAMES KREMLIN
 SIC 5-4-21 Nishihashimoto Midori-ku
 Sagamihara Kanagawa 252-0131 Japan
 Ph: 042 703 4430
 Mobile: +81 (0)45 412 5800

PORTUGAL

SAMES KREMLIN
 Rua da Silveira, 554 - Touria
 2410-269 POUSOS LRA
 Ph: +351 244 848 220

SPAIN

SAMES KREMLIN
 C/Botánica, 49
 08908 L'HOSPITALET DE LLOBREGAT
 BARCELONA
 Ph: +34 93 264 1540

ITALIA

SAMES KREMLIN
 Linate Business Park
 Strada Provinciale Rivoltana 35
 20096 Pioltello (MI)
 Ph: +39 (0)2 48 95 28 15

RUSSIA

SAMES KREMLIN
 Application Lab since the beginning of 2020
 Rodionova str. 134.
 603093, N. Novgorod - Russia
 Ph: +7 831 467 8981



INDIA

SAMES KREMLIN
 GAT no - 634, PUNE NAGAR Road, Wagholi
 PUNE - 412 207
 Ph: +91 (0)20 30472700/01

CHINA

SAMES KREMLIN
 Application Lab
 Building No.9, No.3802 Shengang Road
 Songjiang District
 SHANGHAI 201613
 Ph: +86 21 5438 6060



Range of powder equipment

THE **SAMES KREMLIN** POWDER ELECTROSTATIC RANGE IS MADE OF THREE TYPES OF APPLICATORS:

- **MANUAL GUN**, including **Inogun M** used most of the times for small batches or for touch up after or before an automatic system.
- **ROBOTIC APPLICATOR**, including **INOPELL R** with high speed turbine for enhanced finishing quality and **INOGUN R/RC/RD** applicator for general industry applications.
- **AUTOMATIC APPLICATOR**, including **Inogun A** & **INOPELL** used to spray large series with high flow rate. Most of the times, several guns are installed vertically or horizontally.

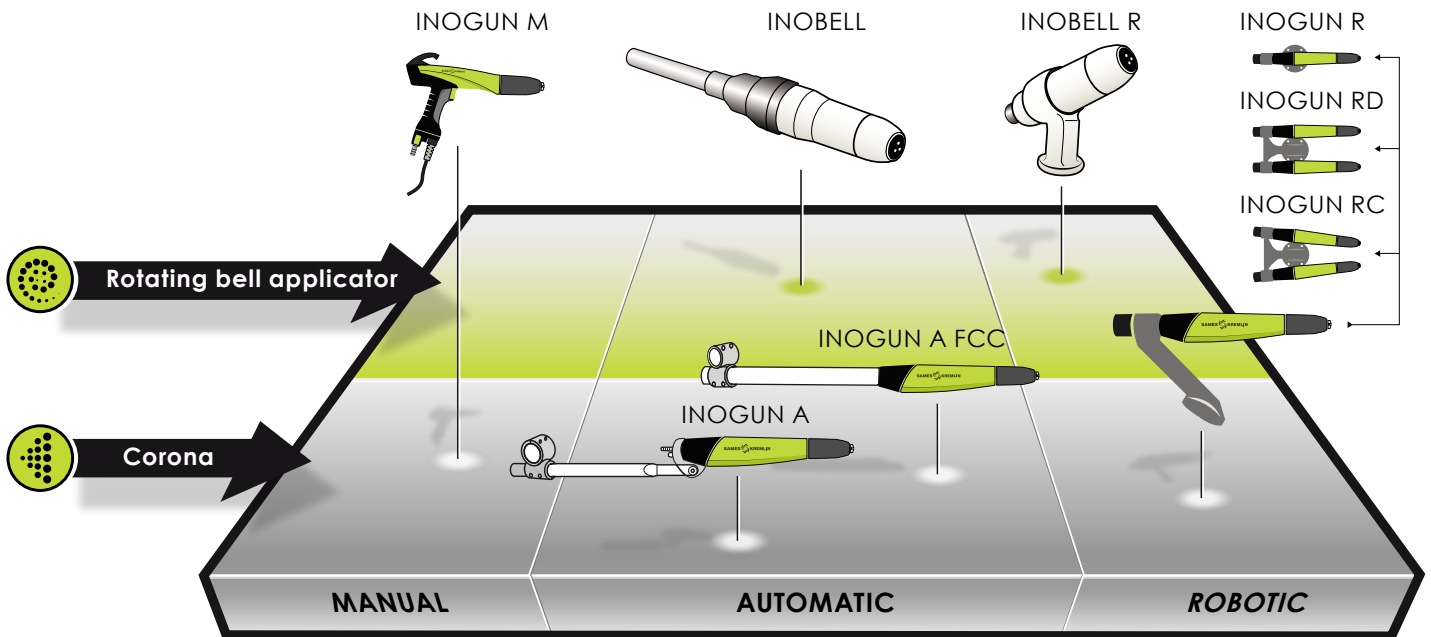

WHEN USING CORONA OR BELL ?

Corona applicator

Very versatile, the fan spray favors penetration in recesses and folds. Target distance may be a factor.

- Good penetration and wrap around
- Complex shapes
- Used for touch up
- Automatic or manual
- High Transfer Efficiency

Rotating bell applicator

Designed for coating large flat surfaces, the bell can spray all kinds of powders with a film build accuracy of +/- 5 microns.

- Wraparound effect
- Wide pattern (up to 450mm)
- High flow (>200g/min up to 500g/min)
- Homogeneous thickness (+/-10%)
- Automatic or robotic
- High transfer efficiency

Range of the powder equipment

Manual equipment range

	Control module				Powder feed system			
	Inobox VT	Inobox H	Inobox NF	Inocontroller	CS 130	CSV 217 (HF)	CSV 230 (NDT)	Inocenter
Inogun M	-	-	✓ ⁽²⁾	-	✓	-	-	-
	-	-	✓ ⁽²⁾	-	-	-	✓	-
	-	-	-	✓ ⁽³⁾	✓	-	-	-
	-	-	-	✓ ⁽³⁾	-	-	-	✓
Inocart VT	✓	-	-	-	✓ ⁽⁴⁾	-	-	-
Inocart H	-	✓	-	-	✓ ⁽⁵⁾	-	-	-
Inocart HF	-	-	✓	-	-	✓	-	-
Inocart NDT	-	-	✓	-	-	-	✓	-

Automatic applicator range

	Control module		Support			Powder feed system			
	Inocontroller or Inobox NF	TCR	Arm	Tube		CSV 130	CSV 217 (HF)	CSV 230 (NDT)	Inocenter
			Ø 30 mm	Ø 40 mm	Ø 50 mm				
Inogun A	✓	-	✓	-	-	✓ ⁽¹⁾			
Inogun A FCC	✓	-	-	✓	-				
Inobell	-	✓	-	-	✓				

Robotic applicator range

	Control module		Robotic support			Powder feed system			
	Inocontroller	TCR	1 applicator	2 applicators		CSV 130	CSV 217 (HF)	CSV 230 (NDT)	Inocenter
				parallel	convergent				
Inogun R	✓	-	✓	-	-	✓ ⁽¹⁾			
Inogun RD	✓	-	-	✓	-				
Inogun RC	✓	-	-	-	✓				
Inobell R	-	✓	✓	-	-				

(1): Compatible for use

(2): The module can be fixed on a wall bracket;

(3): The module can be integrated in a cabinet with a supervisor

(4): The equipment is also available in a 2 operator version = **Inocart VT2**

(5): The equipment is also available in a 2 operator version = **Inocart H2**

NF: No fluidization, control module version without fluidization air dedicated only to **Inocart HF** or **Inocart NDT** equipment or **Inogun M alone**

M: Manual; **A**: Automatic; **FCC**: Fast Color Change

R: Robotic; **RD**: Twin parallel support; **RC**: Twin convergent support

VT: Vibrating Table; **H**: Fluidization Hopper; **H2**: Equipment for use with 2 operators

HF: High Flow, pressure tank is intended for the application of high thickness application

NDT: Non Destructive Testing, pressure tank designed to supply dry developer

Inogun M

The **Inogun M** gathers all **SAMES KREMLIN**'s knowledge and expertise to provide the best of electrostatic technology for the manual application of powder.



- **Lifetime finish quality:** Long life cascade durability and HV performance
- **Efficient powder transfer:** TEC5 technology
- **Balanced and ergonomic design:** No repetitive strain damage, less fatigue

USER-FRIENDLY AND ERGONOMIC MANUAL POWDER GUN

TECHNOLOGIES:

TEC5
(Transfer Electronic Control)

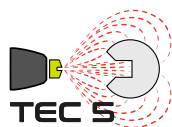

CORONA CHARGE

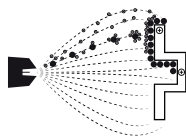

TECHNICAL DATA

GUN	Inogun M / M+
Weight of the gun (without cable and hose)	549 g
Length gun only	340 mm
Air Consumption	2 - 10 m ³ /h
Powder flow ⁽¹⁾	up to 24 kg/h
Powder hose	Lg. 6m ø11 mm
Max output voltage negative (HVU)	-100 kV (0 kV, -10 kV)
Max output voltage positive (HVU)	+100 kV (0 kV, +10 kV)
Max current	110 µA (+ or - 10 µA)
Ambient temperature during operations	0° to 40°C
Relative Humidity Max	80 %
CONTROL MODULE	Inobox NF
Air feeding pressure	7 bar (+/- 1)
Weight	3.9 kg
Protection index	IP64 - Degree of pollution: 2
Power supply	100 VAC at 240 VAC / 50 Hz - 60 Hz
Maxi input power	105 W at 230 VAC

(1): it depends on the type of powder hose

ATEX MARKING:

Inogun M & Inogun M+

CE 0080 II 2 D 2mJ T85°C
INERIS 19ATEX0021X

When configured according to 800004734
For Electro. Fin. Appl. CL. II, Spray Matt.

Inobox

CE 0080 II 3 (2) D [2 mJ]
Ex tc III C T85°C Dc
INERIS 19ATEX0021X

When configured according to 800004734
For Electro.Appl.CL. II, Div 2, Group F, G

Inogun M

DESCRIPTION



The **Inogun M** is designed to provide the best quality powder application because it is well-balanced, supplied with low voltage cable, powder tube and reactive trigger that requires a gentle touch.

The **powerful high voltage** unit coupled with the high voltage control unit provides a high wraparound effect on large parts (D. 500mm / 20 in) and has deep penetration into recessed areas. This reduces the cost of the equipment with a better powder usage rate and reduces the time to spray the powder.

The **Inogun M** is controlled by the Inobox which has a clear and **easy to use interface**. The connected integrated Inocontroller can also be used when it is necessary to integrate an automatic booth. The **Inobox** and the **Inocontroller** are the main control centers for manual and automatic applications as it performs and controls:

- high voltage,
- current,
- electrode cleaning air,
- injection air,
- and dilution air.

Dust and energy saving has been implemented at the heart of the gun to reduce waste, and increase productivity and the quality of finishing powder.



Inobox allows a comfort of use for your production line, manages the programs for your campaigns of parts as well as pre-settings optimized to the shapes of the parts to be painted.

The **Inogun M** is available in different kits according to the needs of your powder coating process. The **Inogun M** can be used as a main applicator to perform powder coating and can be mounted on a **tank** or independent powder supply box on a **vibrating table**.

The **Inogun M** can be used as a **pre-touch or touch-up solution** in an automatic booth to obtain the desired coating on the workpiece. The Inogun M is also used for **non-destructive testing** applications.

Inobox NF

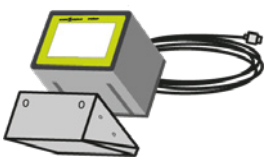

Quick access to application settings through an intuitive interface.

Inocart VT



Capacity: 15 l. (3.96 gal)

Complete equipment with vibrating table for fast and frequent color changes.

Inocart H



Capacity: 50 l (12.5 gal)

Complete equipment with fluidized tank for high production and complex powders.

Inocart HF & NDT



Capacity: HF - 24 l. (6.35 gal)
NDT - 15 l. (3.96 gal)

Fully equipped with a pressure tank. **2 versions** available:
NDT very low flow rate for penetrant testing,
HF very high flow rate, thick film.

Inogun M

PERFORMANCE

- 1 Outstanding comfort of use: well-balanced and comfortable handle grip
- 2 Quick hose powder disconnection: quick color changes and rotation for flexibility
- 3 Constant and stable spray for a smooth and even application
- 4 TEC5 technology delivers high finish quality
- 5 Three factory presets for quick start. 99 custom presets available to meet the most production requirements

PRODUCTIVITY

- 4 Advanced HV control for an excellent penetration of complex-shaped parts
- 6 Wide range of adapted nozzles for optimal application
- 7 Powerful cascade providing a strong wraparound effect
 - Easy application of metallic powder
 - Fast color change and cleaning
 - High transfer efficiency to reduce working time

SUSTAINABILITY

- 1 Robust and sturdy design
- 5 Wear part status monitoring imbedded in the INOBOX controller
- 6 Very good abrasion resistance for nozzles
 - 2+1 years warranty *

* except wearable parts, see conditions to apply on the warranty page of our web site

TEC5 TECHNOLOGY

(Transfer Electronic Control)

TEC5 technology processor will automatically adjust the voltage giving the best application. It takes into account the powder flow and distance of the parts to deliver the highest powder transfer and finish quality.

TEC5 technology is the 5th generation and is the result of 55 years of innovation, experience, and knowledge from SAMES KREMLIN. Our expertise has been used to develop two new major components which are the High Voltage unit (cascade), and the High Voltage control system (processor).

The TEC5 diagram shows the spraying distance & High Voltage as it highlights that beyond 300 to 400 mm between the powder gun and the part that is to be coated, the powder receives a very high voltage with low current; therefore, the powder doesn't get enough charge which decreases the transfer efficiency and wrap-around effect. At the opposite end of the scale, under a distance of 30 mm (red zone of the diagram) to the part to be coated, the current increases very quickly, and the control system shuts down the High Voltage and current to avoid any potential hazards.

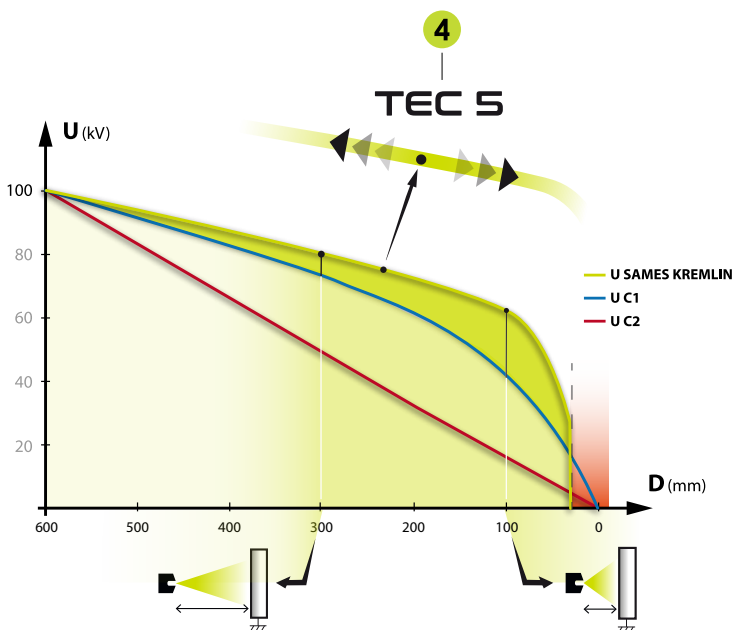

C1/C2: Voltage curve of competitors

Area where the TEC5 balances the current and the voltage to have the best result.

more information



AVAILABLE GUN CONFIGURATIONS

Description	Low voltage cable (m)	Powder hose (m)	Wall support	Inobox NF ⁽¹⁾	Inocontroller	CS130	CSV217 ⁽³⁾	CSV230 ⁽⁴⁾	Part Number	
Equipped Inogun M ⁽²⁾	6	-	-	-	-	-	-	-	910030034	
	12	-	-	-	-	-	-	-	910030034-12	
	18	-	-	-	-	-	-	-	910030034-18	
Equipped Inogun M+ ⁽⁷⁾	6	-	-	-	-	-	-	-	910031951	
	12	-	-	-	-	-	-	-	910031951-12	
Pack Inogun M ⁽²⁾	6	6 (ø11x16 mm)	✓	✓	-	✓	-	-	910030368	
		6 (ø9x13 mm)	✓	✓	-	-	✓	-	910031462	
		6 (ø6x10 mm)	✓	✓	-	-	-	✓	910030370	
	12	12 (ø11x16 mm)	✓	✓	-	✓	-	-	910030368-12	
		12 (ø9x13 mm)	✓	✓	-	-	✓	-	910031462-12	
		12 (ø6x10 mm)	✓	✓	-	-	-	✓	910030370-12	
	18	18	-	✓	✓	-	✓	-	-	910030368-18
			-	-	-	✓	-	-	-	910030628
			-	-	-	✓	✓	-	-	910030627

OPTION NOZZLES

Description	Nozzle support	Deflector		Lenght	Part Number	
		Round spray	Flat spray		Round spray	Flat spray
Round spray electrode support	✓	-	-	-	910027641	-
Round spray deflector	-	ø12 mm	-	-	1411500	-
		ø16 mm	-		1409259	
		ø20 mm	-		1409260	
		ø25 mm	-		1411993	
		ø16 mm HD ⁽⁵⁾	-		900008026	
		ø20 mm HD ⁽⁵⁾	-		900008027	
Flat spray electrode support	✓	-	-	-	-	910027640 ⁽⁶⁾
Flat spray deflector	-	-	Medium (grey)	-	-	900016321 ⁽⁶⁾
			Narrow (green)			900019952
			Large (black)			900020796
Extended nozzle	-	-	-	150 mm	910028576	910028485
				300 mm	910028575	910028486
				450 mm	910030942	910032772
				600 mm	910029099	910032773
				1050 mm	910031754	-
				1500 mm	910032437	-
Large flat spray deflector for extension nozzle - Option					-	900021864
Counter electrode for manual gun					910031755	
Kit for converting a flat spray into a round spray					910032710	
Kit for converting a round spray into a flat spray					910032709	

(1): NF = No fluidization, control module version without fluidization air (P/N: 910030576); (2): Supplied with low voltage cable and medium fan spray nozzle (PN: 900016321); (3): Pressure tank HF: High Flow; (4): Pressure tank NDT: Non Destructive Testing; (5): HD = High Durability, suitable for «abrasive/aggressive» powder except for enamel coating powder; (6): Supplied with the Inogun M gun as standard; (7): Positive electric charge gun version



Inogun M



Powder hose

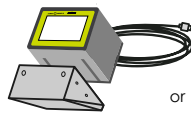

Inobox NF

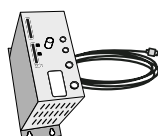

Inocontroller

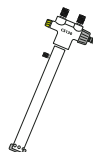

CS130



CSV217/CSV230

flat or round spray electrode support

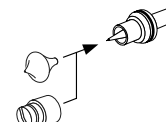

Deflector

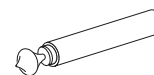

Extended nozzle

Equipped Inogun M

Pack Inogun M

Nozzles

Inocart equipment range

Ergonomic, reliable and performing, the solution Inocart is the combination of the best technologies. It has been specially designed for companies looking to improve their powder coating application and the overall efficiency of the operator.

Available in four versions:

Inocart VT / VT2

Complete equipment with vibrating table for fast and frequent color changes.



Inocart H / H2

Complete equipment with fluidized tank for high production and complex powders.



Inocart HF & Inocart NDT

Fully equipped with a pressure tank. 2 versions available:

NDT very low flow rate for penetrant testing (as low as **3g/mn**),

HF very high flow rate, 1200g/mn, high film build.



SPECIFICATIONS DETAIL FOR EACH EQUIPMENT

Designation	Inocart VT	Inocart H	Inocart HF	Inocart NDT
Air Supply Pressure	7 bar (+/- 1) (101.5 psi)			
Air Consumption	2 - 10 m ³ /h (1.1 - 5.9 cfm)		5 - 12 m ³ /h (2.9 - 7 cfm)	
Standar flow rate ⁽¹⁾	50 to 450 g/min. (15.8 oz/mn)		100 to 1200 g/min. (42 oz/mn)	3 to 50 g/min. (1.75 oz/mn)
Box or Hopper Capacity	15 l. (3.96 gal)	50 l (12.5 gal)	24 l. (6.35 gal)	15 l. (3.96 gal)
Height	1230 mm (48.4 In)			
Width	490 mm (19.2 In)			
Length	630 mm (25 In)	670 mm (26.4 In)	710 mm (28 In)	
Approximate weight (without powder)	42 kg (92.5 lbs)	42 kg (92.5 lbs)	45 kg (99 lbs)	40 kg (82 lbs)
CONTROL MODULE	Inobox VT	Inobox H	Inobox NF	Inobox NF
Maximum Air Pressure	7 bar (+/- 1)			
Protection index	IP64 - Degree of pollution: 2			
Power supply	100 VAC at 240 VAC / 50 Hz - 60 Hz			
Maxi input power	105 W at 230 VAC			
Fluidization air flow rate plunger tube	0.4 m ³ /h	-	4.8 m ³ /h max.	
Tank fluidization air flow rate	-	2.1 m ³ /h		
Electrode blowing	0.1 m ³ /h	0.1 m ³ /h		
Powder coating	6.5 m ³ /h	8.5 m ³ /h		
In cleaning	9.5 m ³ /h	9.5 m ³ /h		
Air consumption of Fast Clean at 7bar	7 l/s per pulse	-		

(1): it depends on the type of powder hose and maximum 30 gr/min with dry penetrant powder.

ATEX MARKING:

Inogun M & Inogun M+
 CE 0080 II 2 D 2mJ T85°C
 INERIS 19ATEX0021X

Inobox VT - Inobox H - Inobox NF
 CE 0080 II 3 (2) D [2 mJ]
 Ex tc IIIC T85°C Dc
 INERIS 19ATEX0021X
 When configured according to 800004734
 For Electro.Appl.CL II, Div 2, Group F, G

Inocart VT - Inocart H - Inocart HF - Inocart NDT
 CE 0080 II 3 D Ex h IIIC T100°C Dc
 CS130
 CE II 3 D c T 85°C

Inocart equipment range

THE EQUIPMENT

Our **Inocart range** is designed for manual powder coating. The minimum equipment required for Inocart coating includes a pump(1), a powder hose(2), a control module (3), a spray gun(4) and a trolley(5) that integrates the various powder paint supply systems:

- Box (VT)
- Hopper (H)
- Pressure tank (HF & NDT)

The powder pump is equipped with a suction rod(6), suitable for the vibrating table or fluidised tank trolley version.

The gun is connected to the pump by a single powder feed hose and to the Inobox control module which allows the operator to easily adjust the paint application settings:

- Powder flow
- Voltage and current for electrostatic coating
- Coating program and part campaign
- Electrode blowing air

The operator has the ability to adjust the flow rate of the powder and electrical characteristics preset voltage/current levels from the gun.

The choice of equipment must be made according to the nature of the powder paints, the frequency of colour changes and the type of parts to be painted.

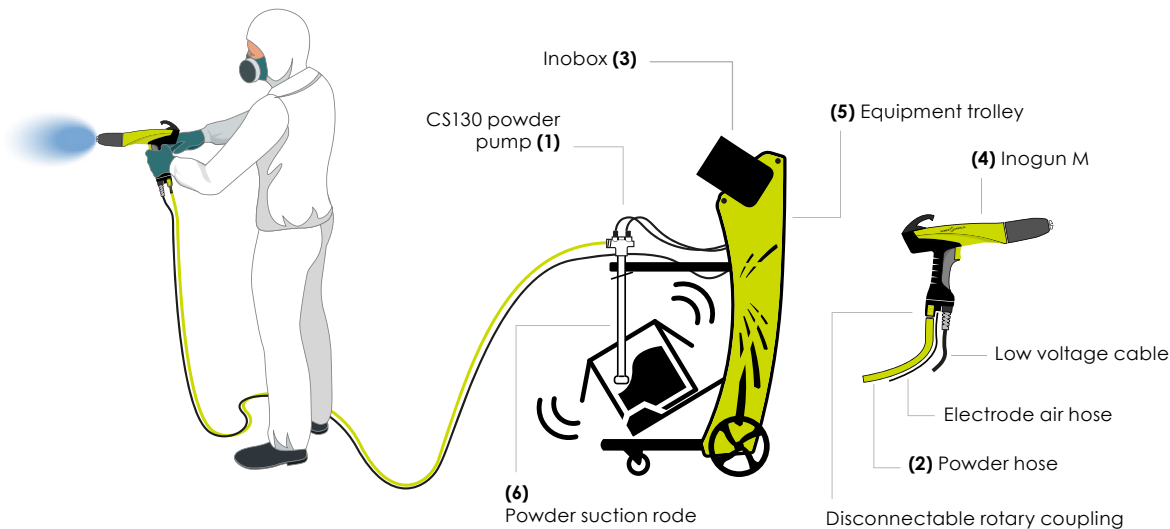

DESCRIPTION

Inocart VT is perfect for applying an even spray pattern for powders like polyester, epoxy, or acrylic which are supplied in 20 kg (44 lb) boxes. The vibrating table liquidizes the powder and allows the powder pump to move the powder swiftly through the tubing to the manual gun.

Inocart HF is designed to apply thermoplastic and anti-corrosion powders. In order to obtain a thick powder layer (up to 500 µm) in one pass, the pressure pot CSV 217 offers a usable volume of 24 liters - 6.3 US Gal (ie: a range of about 8 minutes at 1200 g/min - 42.3 Oz/min).

Inocart NDT is designed for Non-Destructive Testing processes to apply powder developer. This application process is widely used in the aerospace market. Powder is finely applied in a homogenous layer with the substrate still visible. In order to obtain film thickness, the CSV 230 pressure tank will enable the best movement of powder to the gun for the required application.

Inocart H is perfect for all types of powders, including metallic and material-filled powders. The hopper, with a capacity of 50 liters (13.2 US gallons), ensures a very stable powder spraying.



Inocart VT

Inocart VT is a simple and complete manual solution for applying powder. Partnering the Inogun M spray gun and the Inobox control module enhances the user's experience. It contains a user-friendly interface with advanced ergonomic functions to help maintain the focus on the powder application and the finish quality.

- **Fast color changes: Under 25 seconds to clean**
- **Efficient powder transfer: TEC5 technology**
- **Easy to operate: 2 minutes from training to production**

USER-FRIENDLY COMPACT EQUIPMENT FOR EXCEPTIONAL FINISH

TECHNOLOGIES:

TEC5
(Transfer Electronic Control)

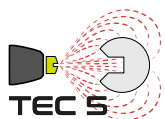

CORONA CHARGE

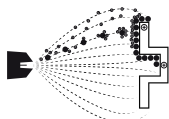

VIBRATING TABLE



PERFORMANCE

- 1 Constant and stable spray pattern for a smooth and even application
- 1 Well-balanced gun for easy maneuvering
- 2 Three factory presets for quick start. 99 customer presets available to meet production requirements
- 2 Inobox height can be easily adjusted for reading
 - TEC5 technology delivers high-quality finish
 - No puffing

PRODUCTIVITY

- 1 Powerful cascade providing a strong wraparound effect
- 2 Advanced HV control for excellent penetration of complex-shaped parts
- 2 Simple and instant control of powder flow rate
- 3 Electric vibrating table
- 4 Self-locking hook to maintain the gun and the pump during cleaning
- 5 Dedicated foot rest to easily move the Inocart
 - High transfer efficiency to reduce processing time

SUSTAINABILITY

- 1 Unsurpassed cascade performance lifetime
- 2 All wear parts are monitored on the controller to encourage proper preventative maintenance
- 6 Designed for industrial use
 - Built with proven and high-quality components
 - 2+1 years warranty *

* except wearable parts, see conditions to apply on the warranty page of our web site

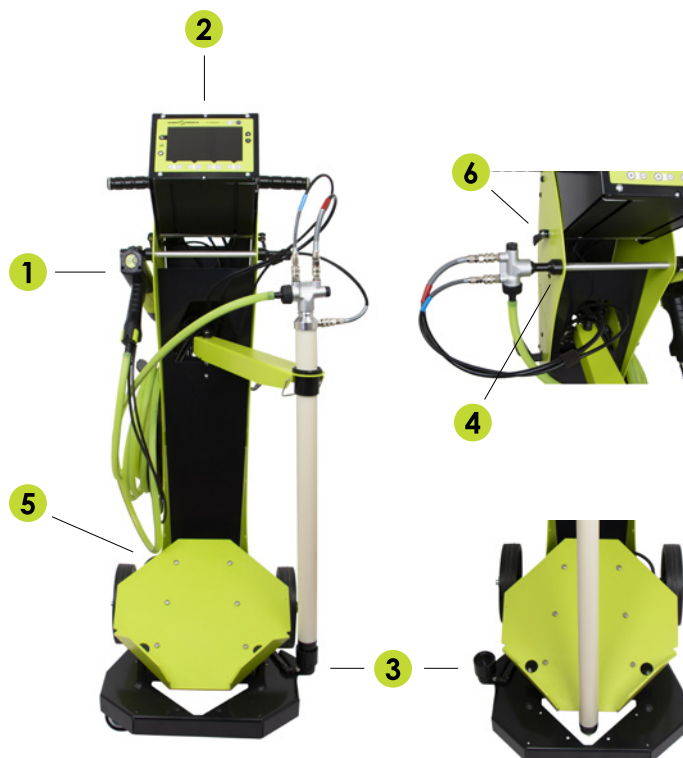

Inocart VT

MANUAL POWDER COATING EQUIPMENT

Description	Number of guns	Low voltage cable (m)		Powder hose (m)($\varnothing 11 \times 16$ mm)		Part Number
		6	12	6	12	
Equipped Inocart VT	1	✓	-	✓	-	910029950
	1	-	✓	-	✓	910029950-12
Equipped Inocart VT2 ⁽¹⁾	2	✓	-	✓	-	910030364
		✓	-	-	✓	
Equipped Inocart VT+ ⁽²⁾	1	✓	-	✓	-	910033422
	1	-	✓	-	✓	910033422-12

(1): VT2, dual operators set supplied with :

- 1 Inocart VT including 1 Inobox VT + 1 Inogun M (6m for powder and air hoses) + 1 powder tube

- 1 Pack Inogun M with 1 Inobox VT + 1 Inogun M (12m for powder hoses and 6 m for the low voltage cable) + 1 powder tube + 1 wall support

(2): Positive electric charge gun version



Inocart VT + Inobox VT

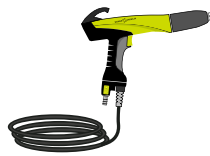

Inogun M

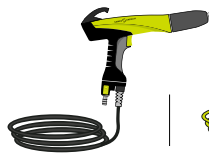

Inogun M



Powder hose

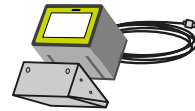

Inobox VT
Wall support



CS130 with
fluidized tube

Equipped Inocart VT

Pack Inogun M

Equipped Inocart VT2

POWDER COMPONENTS CS130

Description	Item	Part Number
CS 130 (alone)	3	910013775
Plunger tube for E. Inocart VT	4	910025252
Metallic air injector	A	910014564
Plastic air injector	A'	910014565
Red washer 1/8	B	EU9000853
Quick release connector 1/8" BSP	C	EU9001083
Releasable connector 1/8" BSP	D	F6RAJR025
Blue washer 1/8	E	EU9000854
Venturi tube assembly	F - Grey	910014388
	Option white	910014390
O-ring-Black viton	G	J2FTDF273
Anti-static outlet tip	H	900008907
Connection nut	I	900008904

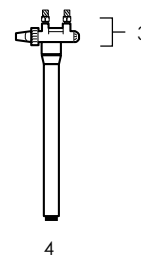

Powder pump

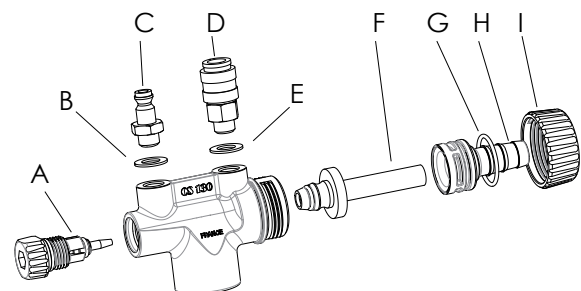

Inocart H

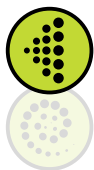

USER-FRIENDLY COMPACT EQUIPMENT READY TO SPRAY

Inocart H is a simple and complete manual solution with a fluidized hopper for spraying powder. Partnering the Inogun M spray gun and the Inobox control module enhances the user's experience. It contains a user-friendly interface with advanced ergonomic functions to help maintain the focus on the powder application and the finish quality.

- **Highest finishing quality:** High fluidization for smooth and constant application of difficult powders
- **Efficient powder transfer:** TEC5 technology
- **Easy to operate:** Less than 2 minutes from training to production

TECHNOLOGIES:

TEC5
(Transfer Electronic Control)

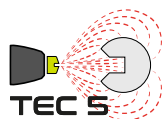

CORONA CHARGE

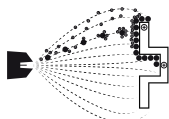

HOPPER



PERFORMANCE

- 1 Constant and stable spray pattern for a smooth and even application
- 1 Well-balanced gun for easy maneuvering
- 2 Three factory presets for quick start. 99 customer presets available to meet production requirements
- 2 Inobox height can be easily adjusted for reading
 - TEC5 technology delivers high-quality finish
 - No puffing

PRODUCTIVITY

- 1 Powerful cascade providing a strong wraparound effect
- 2 Advanced HV control for excellent penetration of complex-shaped parts
- 2 Simple and instant control of powder flow rate
- 3 Smooth powder flow with low velocity due to the fluidized hopper
- 4 Self-locking hook to maintain the gun and the pump during cleaning
- 5 Dedicated foot rest to easily move the Inocart
 - High transfer efficiency to reduce processing time

SUSTAINABILITY

- 1 Unsurpassed cascade performance lifetime
- 2 All wear parts are monitored on the controller to encourage proper preventative maintenance
- 3 Stainless steel hopper for industrial use
- 6 Designed for industrial use
 - Built with proven and high-quality components
 - 2+1 years warranty *

* except wearable parts, see conditions to apply on the warranty page of our web site



Inocart H

MANUAL POWDER COATING EQUIPMENT

Description	Number of guns	Low voltage cable (m)		Powder hose (m)($\varnothing 11 \times 16$ mm)		Part Number
		6	12	6	12	
Equipped Inocart H	1	✓	-	✓	-	910030365
	1	-	✓	-	✓	910030365-12
Equipped Inocart H2 ⁽¹⁾	2	✓	-	✓	-	910030366
		✓	-	-	✓	
Equipped Inocart H+ ⁽²⁾	1	✓	-	✓	-	910033423
	1	-	✓	-	✓	910033423-12

(1): H2, dual operators set supplied with :

- 1 Inocart H including 1 Inobox H + 1 Inogun M (6m for powder and air hoses) + 1 powder tube

- 1 Pack Inogun M with 1 Inobox VT + 1 Inogun M (12m for powder hoses and 6 m for the low voltage cable) + 1 powder tube + 1 wall support

(2): Positive electric charge gun version



Inocart H + Inobox H



Inogun M

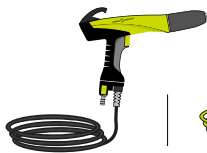

Inogun M



Powder hose

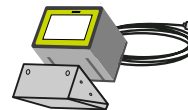

Inobox VT
Wall support

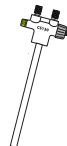

CS130 with
Powder tube

Equipped Inocart H

Pack Inogun M

Equipped Inocart H2

POWDER COMPONENTS CS130

Description	Item	Part Number
CS 130 (alone)	3	910013775
Plunger tube for E. Inocart H	4	910030912
Metallic air injector	A	910014564
Plastic air injector	A'	910014565
Red washer 1/8	B	EU9000853
Quick release connector 1/8" BSP	C	EU9001083
Releasable connector 1/8" BSP	D	F6RAJR025
Blue washer 1/8	E	EU9000854
Venturi tube assembly	F - Grey	910014388
	Option white	910014390
O-ring-Black viton	G	J2FTDF273
Anti-static outlet tip	H	900008907
Connection nut	I	900008904

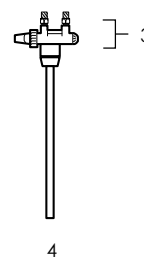

Powder pump

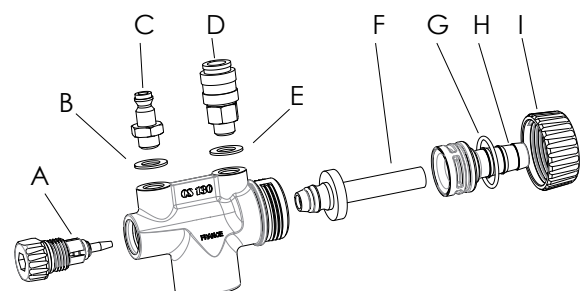

Inocart HF – Inocart NDT

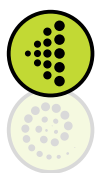

USER-FRIENDLY COMPACT EQUIPMENT READY TO SPRAY

TECHNOLOGIES:

TEC5
(Transfer Electronic Control)

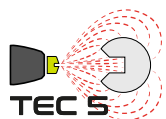

CORONA CHARGE

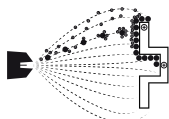

PRESSURE TANK



PERFORMANCE

- 1 Constant and stable spray pattern for a smooth and even application
- 1 Well-balanced gun for easy maneuvering
- 2 Three factory presets for quick start. 99 customer presets available to meet production requirements
- 2 Quick and easy adjustment of the Inobox height for easy information reading
- 3 Capable of very low and regular flow with low speed due to the pressure tank
 - TEC5 technology delivers high-quality finish
 - No puffing

PRODUCTIVITY

- 1 Powerful cascade providing a strong wraparound effect
- 2 Advanced HV control for excellent penetration of complex-shaped parts
- 4 Simple and instant control of the powder flow rate by a shutter lever
- 5 Self-locking hook to maintain the gun and the pump during cleaning
- 6 Dedicated foot rest to easily move the Inocart
 - High transfer efficiency to reduce processing time

SUSTAINABILITY

- 1 Unsurpassed cascade performance lifetime
- 2 All wear parts are monitored on the controller to encourage proper preventative maintenance
- 7 Designed for industrial use
 - Built with proven and high-quality components
 - 2+1 years warranty *

* except wearable parts, see conditions to apply on the warranty page of our web site

- High powder flow for extreme film builds : Up to 1.2 kg/min
- Very low and stable powder flow (as low as 3g/mn):
Exclusive pressure tank
- Easy to operate : Less than 2 min. from training to production

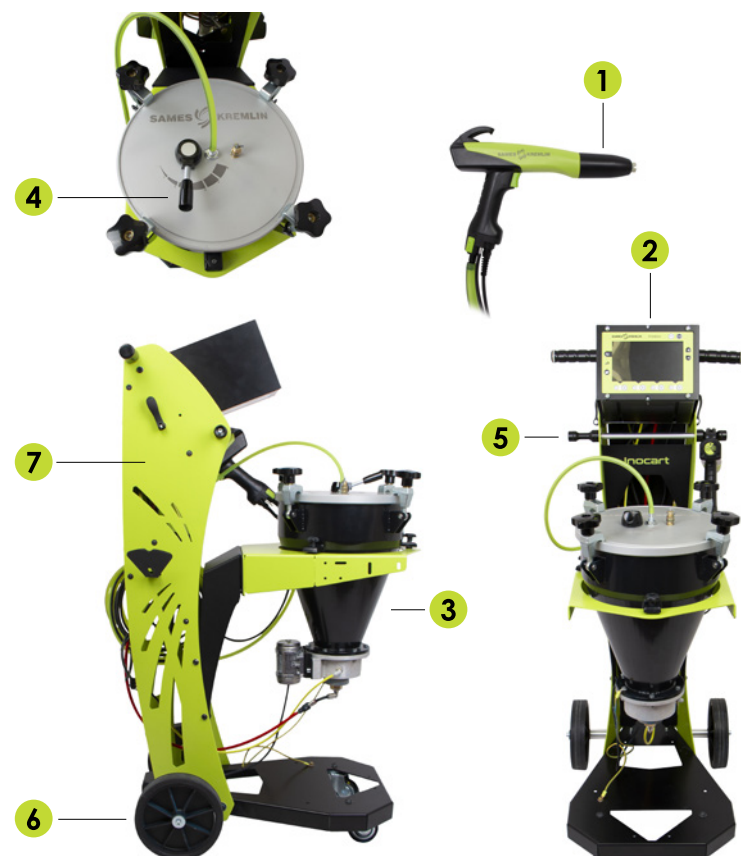

Inocart HF – Inocart NDT

MANUAL POWDER COATING EQUIPMENT

Description	Number of guns	Low voltage cable (m)		Powder hose (m) ø9 x 13 mm : HF ø6 x 10 mm : NDT		Part Number
		6	12	6	12	
Equipped Inocart HF	1	✓	-	✓	-	910030367
		-	✓	-	✓	910030367-12
Equipped Inocart NDT	1	✓	-	✓	-	910030369
		-	✓	-	✓	910030369-12
Equipped Inocart NDT+ ⁽¹⁾	1	✓	-	✓	-	910033424
		-	✓	-	✓	910033424-12

(1): Positive electric charge gun version

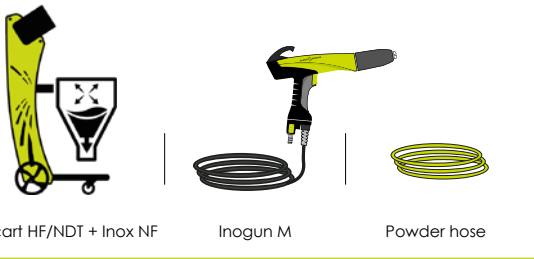

Equipped Inocart HF & NDT

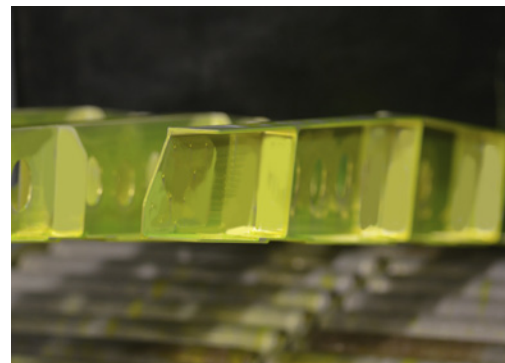

The equipment meets the needs of industrial PT powder developer applications.

Inogun A range

Inogun A sprayer is designed for powder coating in general industry applications. It is generally used as a fixed position or on a reciprocator in a fast color change booth such as **Inoboath**.

Inogun A combines high application performance, easy cleaning and simplicity of use to allow you to increase your productivity and change colors more quickly and efficiently.

Available in two versions:

Inogun A

Projector equipped with an adjustable support arm. It can be easily integrated into all existing cabins or new installations.

Inogun A FCC

Dedicated spotlight for a quick color change booth. Its design assembly delivers perfect cleaning in a very short timeframe.



SPECIFICATIONS DETAIL FOR EACH EQUIPMENT

GUN	Inogun A	Inogun A FCC
Air Consumption	2 - 10 m³/h	
Powder flow ⁽¹⁾	450 gr/mn (63.7 oz/mn)	
Length (gun only)	460 mm (18.1 in)	
Length Inogun A - tube Ø30mm	1046 mm (41.2 in)	-
Length Inogun A FCC - tube Ø40mm	-	1423 mm (56 in)
Width	49 mm (1.9 in)	
Height	69 mm (2.7 in)	
Weight	650 g (23 oz)	
Max voltage	100 kV (0 kV, -10 kV)	
Max current	110 µA (+ or - 10 µA)	
Ambient temperature during operations	0° to 40°C	
Relative Humidity Max	80 %	
CONTROL MODULE	Inocontroller	
Air feeding pressure	7 bar (+/- 1)	
Weight	2.84 kg	
Protection index	IP20	
Using voltage : VLSV ⁽²⁾	24 VDC (min. 21.6 VDC - max. 26.4 VDC)	
Maxi input power	40 W @ 24V DC	

(1): it depends on the type of powder hose

(2): Very Low Safety Voltage : A +24 VDC LPS (Limited Power Source) supply is recommended to supply the Inocontroller module.

ATEX MARKING:

Inogun A & Inogun A FCC

CE 0080 II 2 D 2mJ T85°C
INERIS 19ATEX0021X

When configured according to 800004734 For Electro.Fin.Appl.CLIII.Spray Mill

Inocontroller

CE 0080 II (2) D [2mJ] INERIS 19ATEX0021X

THE EQUIPMENT

The **Inocontroller** is a control module for controlling the automatic **Inogun A** projector or the manual Inogun M spray gun.

The **Inogun A** projector or the **Inogun M** spray gun have the function of projecting the electrically charged powder by means of a high voltage unit integrated into the barrel and delivering up to 100kV and 110 µA.

The **Inocontroller** manages, by microcontroller, the control of the high voltage unit and 3 proportional solenoid valves. In return, a reading of the high voltage and current is performed, as well as the flow of the 3 proportional solenoid valves. The Inocontroller is controlled by a PLC network and accessible for **SAMES KREMLIN** maintenance via **USB connection**.

For instance:
Synoptic of an installation with an Inogun A FCC

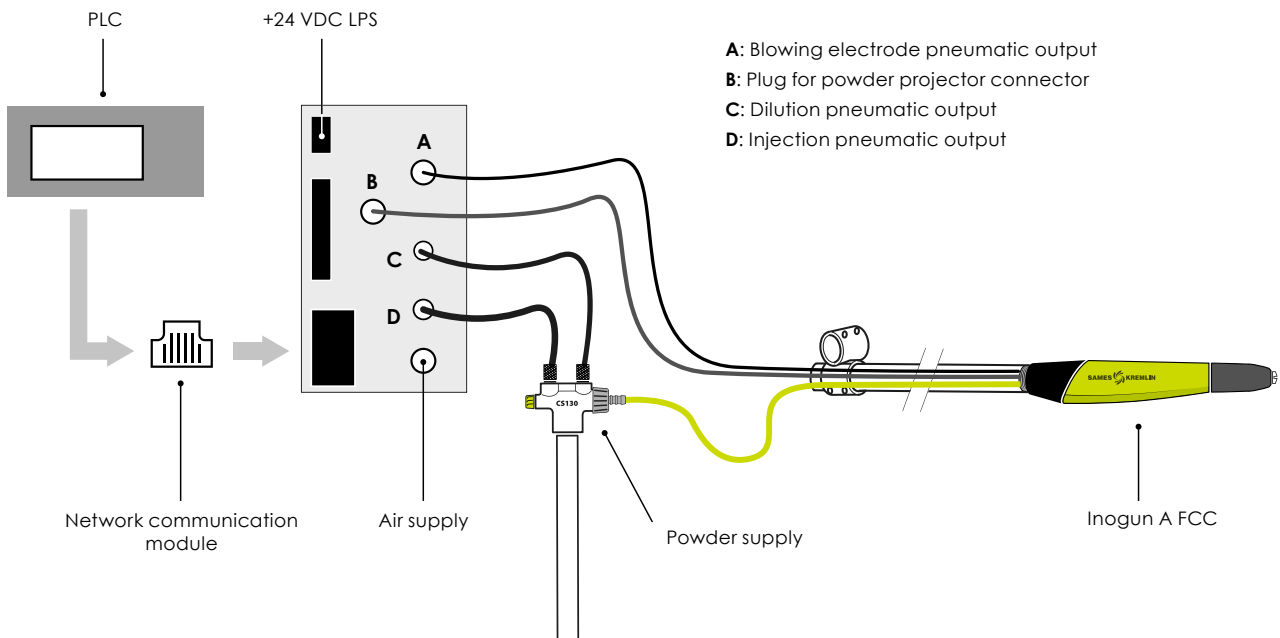

DESCRIPTION

Automatic applicators are used for applying powder to large batches to obtain high transfer efficiency with optimum finish quality.

The automatic spray gun is available in two models:

Inogun A

Equipped with a support arm (metal bar) onto which the Inogun-A is attached: it can be changed or fitted quickly and easily to all existing booths. In this version, the assembly may also be fitted onto new installations.

Inogun A FCC

This version is dedicated to quick color change booth. Its profiled assembly means that it may be cleaned perfectly in a very short time. The rear casing of the spray gun is screwed onto the support arm. This diameter is constant along the entire length. It provides the most efficient color change. The tubular arm is also used to channel the hoses and the electrical connections directly and tidily to the rear of the sprayer.



Inogun A – Inogun A FCC

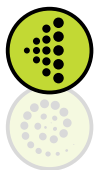

The Inogun A or Inogun A FCC sprayer gather all SAMES KREMLIN's knowledge and expertise to provide the best electrostatic technology for the application of powder in automatic booths.

- **Lifetime finish quality:** Long life cascade durability and HV performance
- **Efficient powder transfer:** TEC5 technology
- **Reduced downtime:** Quick gun change in less than 1 minute

USER-FRIENDLY COMPACT EQUIPMENT FOR EXCEPTIONAL FINISH

TECHNOLOGIES:

TEC5
(Transfer Electronic Control)

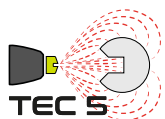

CORONA CHARGE

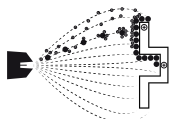

PERFORMANCE

- 1 Easy and accurate settings for voltage and current
- 2 Constant and stable spray for a smooth and even application
 - TEC5 technology offers a high-quality finish
 - Fast color change without cross-contamination

PRODUCTIVITY

- 3 Wide range of adapted nozzles for optimal application
- 4 Powerful cascade providing a strong wraparound effect
- 5 Advanced HV control for excellent penetration in recessed areas
- 5 Widest fieldbus communication protocols for the INOCONTROLLER
 - Modular gun design for an easy integration
 - High transfer efficiency to reduce additional manual work

SUSTAINABILITY

- 3 Highly abrasion-resistant nozzles
- 4 Heavy-duty electrostatic cascade
- 6 Quick disconnect in 1 minute, only 1 operator needed to change gun
 - Robust design
 - 2+1 years warranty *

* except wearable parts, see conditions to apply on the warranty page of our web site



AUTOMATIC POWDER COATING EQUIPMENT

Description	Low voltage cable (m)	Powder hose (m)	Nb. gun(s)	Inobox NF ⁽¹⁾	Inocontroller	CS130	CS217 ⁽³⁾	CSV230 ⁽⁴⁾	Part Number
Equip. Inogun A ⁽²⁾	20	-	1	-	-	-	-	-	910028713
Equip. Inogun A FCC ⁽²⁾	30	-	1	-	-	-	-	-	910028715
Integrator kit Inogun A	20	15 (ø11x16 mm)	1	-	✓	✓	-	-	910028695
			2	-	x2 ✓	x2 ✓	-	910030059	
			1	✓	-	✓	-	910030626	
		15 (ø9x13 mm)	1	✓	-	-	✓	-	910034001
		10 (ø6x10 mm)	1	✓	-	-	-	✓	910030061
Integrator kit Inogun A FCC	30	15 (ø12x17 mm)	1	-	✓	✓	-	-	910028696
			2	-	x2 ✓	x2 ✓	-	910030060	
			1	✓	-	✓	-	910030577	
		15 (ø9x13 mm)	1	✓	-	-	✓	-	910034002
		10 (ø6x10 mm)	1	✓	-	-	-	✓	910030062

Inocontroller module⁽⁷⁾ (connection kit included) 910028596

(7): Network communication module not included: PN: 110002470 Ethernet IP / PN: 110002391 Profinet / PN: 110002472 CC-link / PN: 110002473 Profibus / PN: 110002640 Ethercat

Inobox NF module 910030576

Kit support installation rack 19" pour 1 Inobox 130002186

Kit support installation rack 19" pour 2 Inobox 130002187

Powder hose dia. 11x16 mm **PN: 130001649#** / dia. 12x17 mm **PN: 900017737#** (in lots of 50 meters) / dia. 9x13mm **PN: U1FGBA104# 5**(in lots of 50 meters); dia. 6x10mm **PN: 130002067**

OPTION NOZZLES

Description	Nozzle support	Deflector		Lenght	Part Number	
		Round spray	Flat spray		Round spray	Flat spray
Round spray electrode support	✓	-	-	-	910027641	-
Round spray deflector	-	ø12 mm	-	-	1411500	-
		ø16 mm			1409259	
		ø20 mm			1409260	
		ø25 mm			1411993	
		ø16 mm HD ⁽⁵⁾			900008026	
		ø20 mm HD ⁽⁵⁾			900008027	
Flat spray electrode support	✓	-	-	-	-	910027640 ⁽⁶⁾
Flat spray deflector	-	-	Medium (grey)	-	-	900016321 ⁽⁶⁾
			Narrow (green)			900019952
			Large (black)			900020796
Extended nozzle	-	-	-	150 mm	910028576	910028485
				300 mm	910028575	910028486
				450 mm	910030942	910032772
				600 mm	910029099	910032773
				1050 mm	910031754	-
1500 mm	910032437	-				
Large flat spray deflector for extension nozzle - Option					-	900021864
Counter electrode for automatic gun					910028711	
Kit for converting a flat spray into a round spray					910032710	
Kit for converting a round spray into a flat spray					910032709	

(1): NF = No fluidization, control module version without fluidization air (P/N: 910030576)
 (2): Supplied with low voltage cable and medium fan spray nozzle (PN: 900016321) with support arm dia.30mm for Inogun A (PN: 910029712) or support tube dia.40mm for Inogun A FCC (PN: 910026238)

(3): Pressure tank HF: High Flow

(4): Pressure tank designed to supply dry developer = NDT or low flow rate

(5): HD = High Durability, suitable for «abrasive/aggressive» powder except for enamel coating powder

(6): Supplied with the Inogun A gun as standard;

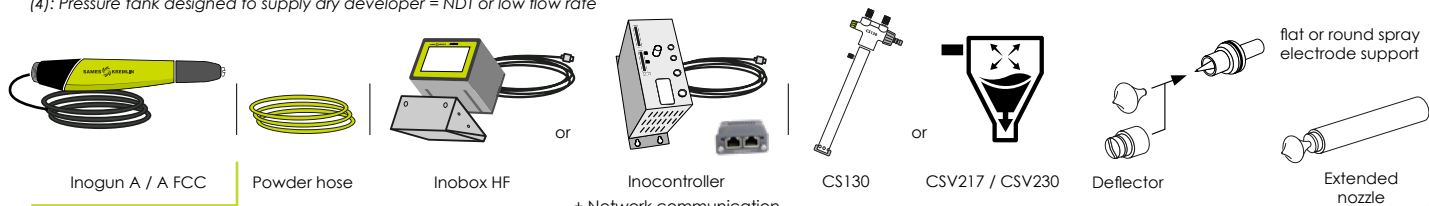

Equipped Inogun A / A FCC

Integrator Kit Inogun A / A FCC

Nozzles

Inobell



InoBell is a rotating electrostatic powder bell sprayer that delivers high performance, excellent finishing quality & easy integration. It allows the application of powder paint on all types of surfaces with a particular effectiveness on flat surfaces.

- High transfer rate
- Easy maintenance
- Easy integration
- Excellent finishing quality

TECHNOLOGIES:

ROTATING BELL APPLICATOR

CORONA CHARGE

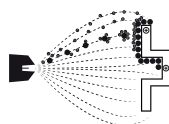

SPECIFICATIONS DETAIL FOR EACH EQUIPMENT

GUN	Inobell
Weight w/o hoses (kg)	3.6
Powder flow ⁽¹⁾ (kg/h)	up to 30
Low voltage cable to TCR (m)	15 or 30
Max voltage (kV)	75
Max current (µA)	100
Pre-set rotation speed (rpm)	7500 (Vmin = 6500 and Vmax = 8500)
Shaping air flow (NI/min)	0 - 80 (proportional from 0 to 100%)
Bearing protective air flow (NI/min)	60
Air supply turbine rotation (NI/min)	40 - 100
CONTROL MODULE	TCR
In a rack (2 modules on front face)	19" / 2U
Air feeding pressure (bar)	7 (+/- 1)
Max air consumption (NI/min)	350
Max air with high flow rate kit (NI/min)	380
Power supply	90/270 Vac - 50/60 Hz
Maxi power (VA)	90



(1): it depends on the type of powder hose

ATEX MARKING:

<p>Inobell</p> <p>CE 0080 II 2D EEx <350 mJ ISseP09ATEX027X</p>	<p>CRN458</p> <p>CE 0080 II (2) D [EEx <350mJ] ISseP09ATEX027X</p>	<p>Powder Turbine Supply</p> <p>CE 0080 II (2) D ISseP09ATEX027X</p>	<p>CS130</p> <p>CE II 3 D c T 85°C</p>
---	--	---	---

THE EQUIPMENT

The **INOPELL** sprayer is equipped with a mechanical bearing turbine. It may have a fixed mounting due to its large impact or on a reciprocator.

This sprayer is piloted by the **TCR** module (1). It manages the rotation speed of the turbine used to spray powder coatings at all times on the digital display on the front face. This module is equipped with a grounded cable, a plug for local command and two connections (2) to control the spray gun and a sensor to measure the speed of rotation.

The powder supply is made thanks to a CS130 powder pump (3).

The powder is brought to high voltage by contact with the bell cup through an integrated high voltage unit into the sprayer. The low voltage is supplied through a specific cable (2) connected inside the INOBELL.

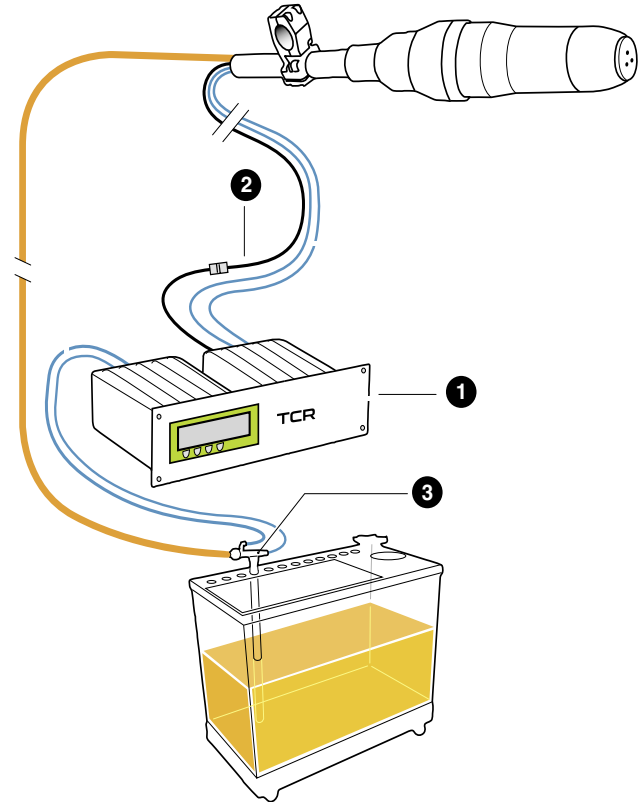

CONTROL MODULE THAT CONTROLS EVERYTHING

- accessible and user friendly,
- adjustment of all functions on screen,
- simplified adjustment of powder flow rates,
- adjustment of air shroud (variable impact),
- turbine rotation is pre-set and controlled,
- 9 spray presets,
- 2 operating modes available:
 - local mode (screen and/or piloting by wire connected triggers),
 - remote mode (monitoring via a series connection),

- storing of parameters,
- easy to wire in,
- clear and visible user interface,
- easier to integrate:
 - Standard size 19" - 2U,
 - Complete unit ready to integrate,
 - No work required on the software,
 - simplified wiring between the module and the sprayer

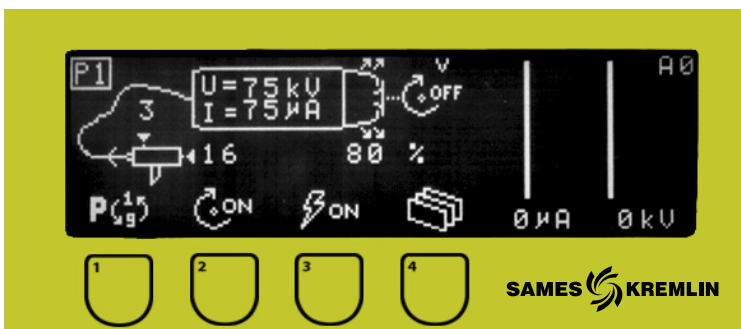

Inobell

PERFORMANCE

- 1 Adjustable air shroud:
Allows a rapid and marked variation in cloud size. Control of the jet can adjust the width of the cloud being implemented, proportionally
 - 2 Excellent regularity of film build-up:
The quality of finish meets the most stringent and tight D.O.I. (Distinctiveness of image).
- Speed detection for increased application control

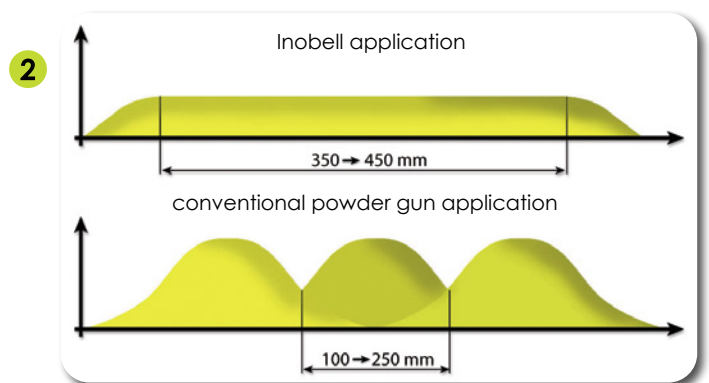
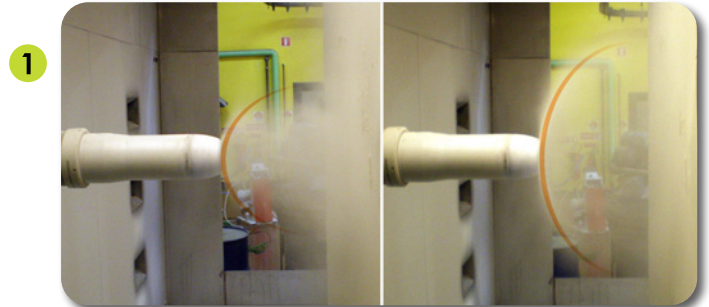

PRODUCTIVITY

- 3 Strong electrostatic charge - up to 20% more transfer efficiency compared to conventional guns
- Flowrate of 1 inoBell equivalent to 2 guns

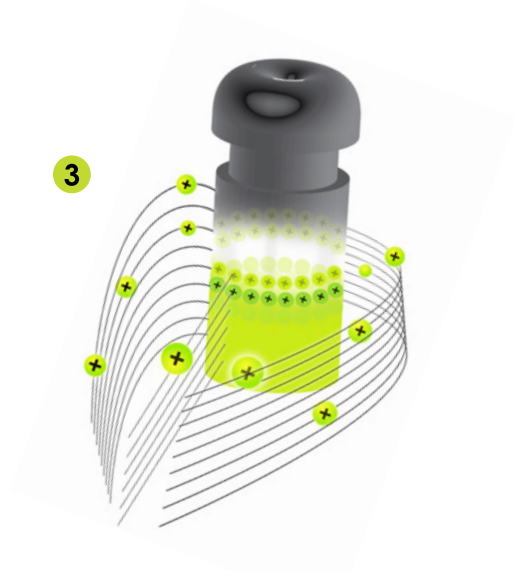

SUSTAINABILITY

- 4 Single block design with fewer number of parts
- 4 Powder bell is easy to disassemble
- 5 Integrated high voltage unit: no high voltage cable

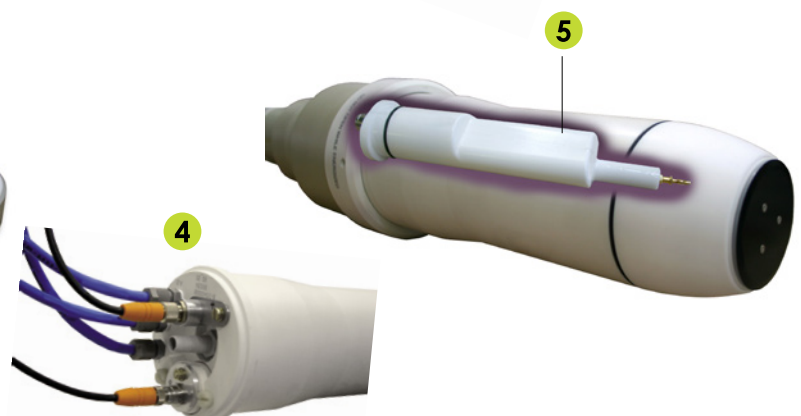

AUTOMATIC POWDER COATING EQUIPMENT

Description	Low voltage cable (m)	Powder hose (m) (ø12x17 mm)	TCR	Fixing nut	Powder pump CS130	Part Number
Equip. Inobell	15	15	-	ø 50x60mm	✓	910020762
Integrator kit Inobell	15	15	✓	ø 50x60mm	✓	910008096

Powder hose dia. 11x15 mm PN: **UIFGBA092#** / dia. 12x17 mm PN: **UIFGBA034#** (hose= in lots of 50 meters)

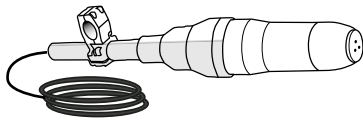

Inobell



Powder hose

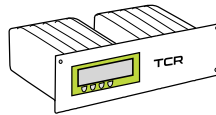

TCR (CRN548)



CS130

Equipped Inobell

Integrator Kit Inobell

COMPONENTS

Mark	Description	Part Number
1	INOPELL sprayer alone	910007600
2	Special support arm length: 400 mm	910009357
	length: 900 mm	910009358
	length: 1500 mm	910009359
3	Nut ø50/50 mm	429104
4	Hose Ø 12/17 mm Green antistatic (50m)	900017737#
option	Hose Ø 11/16 mm (50m)	130001649#
option	Hose Ø 13/18 mm Green antistatic ⁽¹⁾	900017738#
5	Injection air (Ø 6/8 mm) ⁽²⁾	U1CBBT003
6	Dilution air (Ø 4/6 mm) ⁽²⁾	U1CBBT001
7	TCR Control module	900005533
8	High voltage and speed sensor pilot cable ⁽³⁾	910007567
9	Extensions TCR/Inobell	110000972
10	Operating air (Ø 5,5/8 mm) ⁽¹⁾	U1GLBT142
11	Shaping air (Ø 5,5/8 mm) ⁽¹⁾	U1GLBT142
12	Air for protecting bearings (Ø 5,5/8 mm) ⁽¹⁾	U1GLBT142
13	CS130 Powder pump alone and add ref 130001142 (union) + 130001143 + 1526399 (plunger)	910013775

(1): Minimum order of 50 meters; (2): Minimum order of 100 meters. (3): length. 2 x 2 m

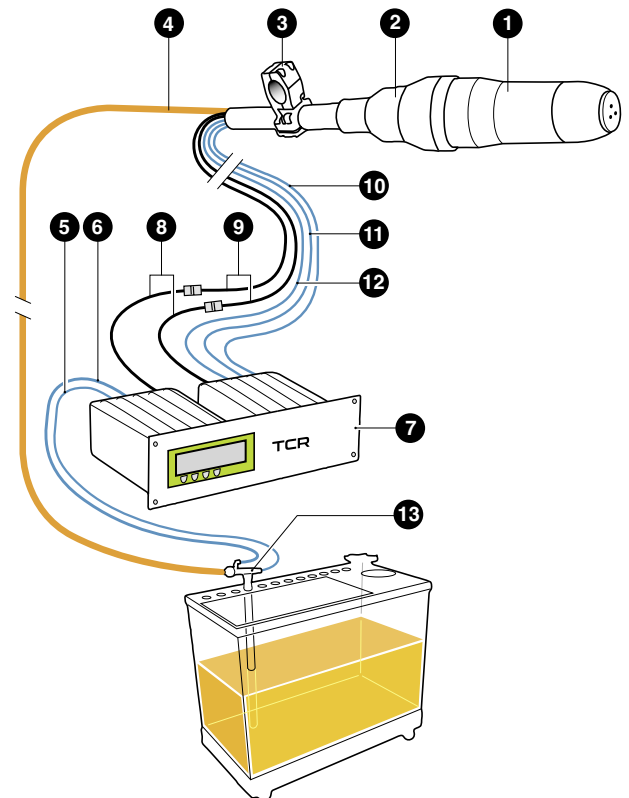

OPTION

Description	Reference
MCR Module	910004516
High flow kit	910003361
Inotank 100 Liter	910031487
Inotank 150 Liter	910031488
Inosieve 100 Liter	910031384
Inosieve 150 Liter	910031385
CS206 air control panel	1502844

Tooling kit	910008097
--------------------	-----------

Robotic application systems

Inogun R / RC / RD

The Inogun robotic applicators are examples of SAMES KREMLIN's knowledge and expertise for providing the best electrostatic technology for robotic powder applications.

- **Lifetime finish quality: Long life cascade durability and HV performance**
- **Efficient powder transfer: TEC5 technology**
- **Reduced downtime: Quick gun change in less than 1 minute**



MODULAR DESIGN FOR FLEXIBLE INTEGRATION AND PROCESS EVOLUTION

TECHNOLOGIES:

TEC5
(Transfer Electronic Control)

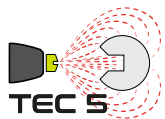

CORONA CHARGE

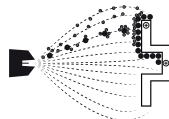

PERFORMANCE

- 1 Easy and accurate settings for voltage and current
- 2 Constant and stable spray for a smooth and even application
 - Fast color change without cross-contamination
- 3 TEC5 technology offers a high-quality finish

PRODUCTIVITY

- 4 Wide range of adapted nozzles for optimal application
 - 5 Powerful cascade providing a strong wraparound effect
 - 6 Advanced HV control for excellent penetration in recessed areas
 - 6 All common communication types are supported by the Inocontroller module
 - Modular gun design for easy integration
- Sustainability

SUSTAINABILITY

- 4 Highly abrasion-resistant nozzles
- 5 Heavy-duty electrostatic cascade
- 7 Quick disconnect 1 minute, only 1 operator needed to change gun
 - Designed for heavy industrial use
 - 2+1 years warranty *

* except wearable parts, see conditions to apply on the warranty page of our web site

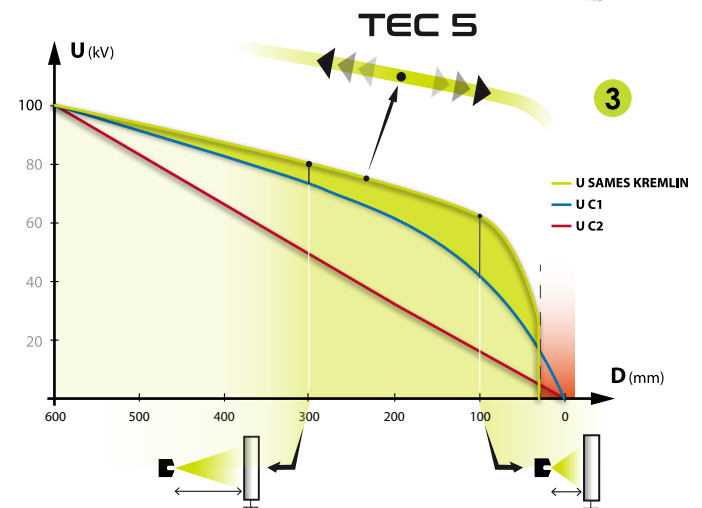

C1/C2: Voltage curve of competitors



Inogun R / RC / RD

DESCRIPTION

The **Inogun robotic** applicator built with a common base are thoroughly tested for robotic powder applications.

We are providing **3 different versions** of the applicator and they are fitted with a different robot bracket:

- Inogun R** for a single gun,
- Inogun RD** for parallel guns,
- Inogun RC** for convergent guns.

ADAPTATION TO INDUSTRIAL CONSTRAINTS

- Respond to the evolution of PRODUCTION CAPACITY and application constraints
- Master FINISHING QUALITY of your products through precise and controlled trajectory
- Maximize your productivity GAINS combining robotics and COATING application with electrostatic powder bell
- Improve COMPETITIVENESS of your business and access to NEW MARKETS

ROBOTIC POWDER COATING EQUIPMENT

Description	Low voltage cable (m)	Powder hose (m) (ø12 mm)	Nb. gun(s)	Inocontroller	Powder pump CS130 ⁽²⁾	Part Number
Equip. Inogun R ⁽¹⁾	30	-	1	-	-	910030100
Equip. Inogun RC ⁽¹⁾	30	-	1	-	-	910030101
Equip. Inogun RD ⁽¹⁾	30	-	1	-	-	910030102
Integrator kit Inogun R ⁽³⁾	30	12	2	x2 ✓	x2 ✓	910029967
Integrator kit Inogun RC ⁽³⁾						910029969
Integrator kit Inogun RD ⁽³⁾						910029968
Inocontroller module ⁽⁴⁾ (connection kit included)						910028596

(4): Network communication module not included: PN: 110002470 Ethernet IP / PN: 110002391 Profinet / PN: 110002472 CC-link / PN: 110002473 Profibus / PN: 110002640 Ethercat

(1): Supplied with low voltage cable and medium fan spray nozzle (PN: 900016321) with common part of the Inogun A FCC
 (2): Pump with tube in version without fluidization
 (3): 6 m of robotic sleeve

Powder hose dia. 12 mm (antistatic; PN: 900017737 (hose= in lots of 50 meters)

Counter electrode for automatic gun; PN: 910028711

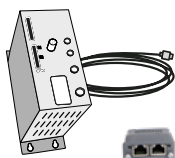
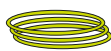
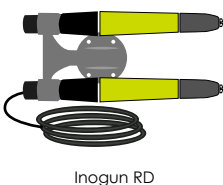
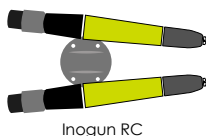
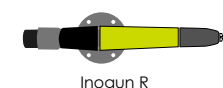

+ Network communication module

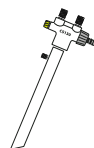

Equipped Inogun R / RC / RD

Integrator Kit Inogun R / RC / RD

Inobell R

Inobell R meets the most demanding criteria of finishing quality, ease of operation, robotic adaptability, electrical safety, reliability, and ease of maintainability.

- Increased productivity
- Excellent finishing quality
- Easy maintenance



TECHNOLOGIES:

ROTATING BELL APPLICATOR

CORONA CHARGE

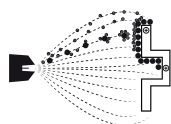

SPECIFICATIONS DETAIL FOR EACH EQUIPMENT

GUN		Inobell
Weight w/o hoses (kg)		5.2
Powder flow ⁽¹⁾ (kg/h)		up to 30
Low voltage cable to TCR (m)		15 or 30
Max voltage (kV)		75
Max current (µA)		100
Pre-set rotation speed (rpm)		7500 (Vmin = 6500 and Vmax = 8500)
Shaping air flow (NI/min)		0 - 80 (proportional from 0 to 100%)
Bearing protective air flow (NI/min)		60
Air supply turbine rotation (NI/min)		40 - 100
CONTROL MODULE		TCR
In a rack (2 modules on front face)		19" / 2U
Air feeding pressure (bar)		7 (+/- 1)
Max air consumption (NI/min)		350
Max air with high flow rate kit (NI/min)		380
Power supply		90/270 Vac - 50/60 Hz
Maxi power (VA)		90

(1): it depends on the type of powder hose

ATEX MARKING:

Inobell
 CE 0080 II 2D
 EEx <350 mJ
 ISSEP09ATEX027X

CRN458
 CE 0080 II (2) D
 [EEx <350mJ]
 ISSEP09ATEX027X

Powder Turbine Supply
 CE 0080 II (2) D
 ISSEP09ATEX027X



Inobell R

ADVANTAGES OF THE ROTATING BELL

The powder is supplied via the central tube and is rotated by the bell cup. It is electrically charged when it leaves the bell and heads towards the object to be coated in a very wide and enveloping spray. The powder is both electrically charged and sprayed by this flat shaped bell, that rotates at high speed. The bell itself acts as an electrode by bombarding the powder particles with ions, thus providing the powder with a high electrical charge.

The rotary bell cup associated to the high voltage ensures:

- A high level of productivity (paint flow of over 500g/min).
- Homogeneous coating.
- An adjustable spray paint pattern.
- A maximum coverage of parts to be paint (the electrostatic wrap round effect permits a transfer of paint behind the part).

TECHNOLOGICAL INNOVATIONS

- Integrated high voltage unit (UHT165)

No high voltage cable:

- Less maintenance,
- Easy to install,
- Staff safety.



- Simplified design:
 - Compact and ergonomic system,
 - Access and wiring improved,
 - Equipment simple to install,
 - Number of parts reduced.

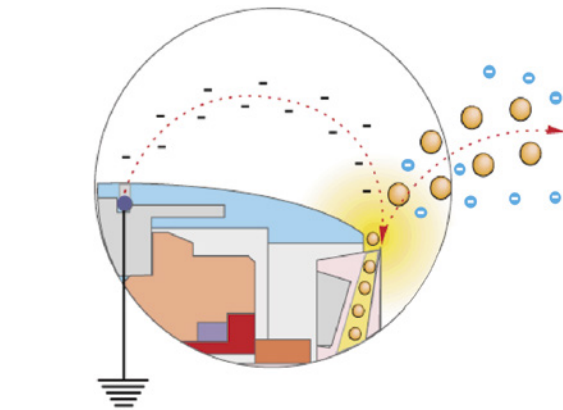

- An economy of paint (the transfer efficiency is high, and can reach over 80%) thanks to the high transfer charge. The precise control of the coating thickness is made possible by the powder bell powder is economised.

- New removable turbine cartridge: Integrated & variable shaping air (proportional adjustment on TCR module),

- Removable powder bell cup,
- Improved bearing protection,
- Improved motor efficiency.



- Flexible air shroud: This enables a fast and marked variation of the size of impact. Controlling the pattern allows the width of the impact to be proportionally adjusted during application (from 300 to 450 mm).

- New speed measuring system:
 - Greater precision in the application of the paint.

ROBOTIC POWDER COATING EQUIPMENT

Description	Low voltage cable (m)	Powder hose (m) (ø12x17 mm)	TCR	Robot support	Powder pump CS130	Part Number
Inobell Projector	-	-	-	-	-	910007600
Integrator kit Inobell R ⁽¹⁾	15	15	✓	✓	✓	910011722

Powder hose dia. 11x16 mm PN: 130001649# / dia. 12x17 mm PN: 900017737# / dia. 13x18 mm PN: 900017738# (hose= in lots of 50 meters)



Inobell projector



Air hoses Robotic support



Powder hose

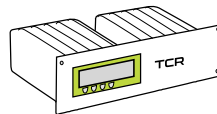

TCR (CRN548)

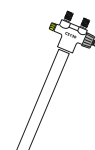

CS130



robotic sleeve

Integrator Kit Inobell R

(1): supplied with robotic support + low voltage connection (15m) + powder hose ø12x17 mm (15m) + air hoses (15m) + Black flexible sleeve (6m) + Powder pump CS130 + Plunger + TCR module

Inorecip

The INORECIP V reciprocator is the best choice for monitoring automatic spray guns and bells in powder coating automatic installations. It features a vertical and horizontal Movement System.

- Simple and rugged construction
- Very long service life
- Reduced maintenance



DESIGNED FOR FLEXIBLE INTEGRATION AND PROCESS EVOLUTION

PERFORMANCE

- Stroke and speed adjustable remotely over a very wide range.
- No special prepared area required (the reciprocator can be positioned or moved manually without effort).

PRODUCTIVITY

- Extremely simple construction and operation (very long service life).
 - Smooth inversion movement for a better coating quality
- Sustainability

SUSTAINABILITY

- Optimum safety - CE approved.
- Reduced maintenance - limited to cleaning the belt and transmission devices.
- Designed for industrial use
- Built with proven and high-quality components



SPECIFICATIONS DETAIL FOR EACH EQUIPMENT

SYSTEM	Inorecip V					
Height (mm)	2524	2824	3124	3424	3724	4024
Stroke (cm)	120	150	180	210	240	270
Empty weight (kg)	278	300	323	350	383	415
Maximum load (kg)	50					
Lifting rings (mm)	Dia. 40					
Diameters of support bars (mm)	Dia. 40 (Horizontal) & Dia. 50 (Vertical)					
Power supply - single phase (VAC)	230					
Max. operating temperature (°C)	40					
Number of guns (max)	12					
Maximum vertical speed (m/min)	36					
Maximum horizontal speed (m/min)	8					
	Inomotion	Inorecip H				
Stroke adjustment (m)	-	up to 1				
Height (mm)	182	273				
Width (mm)	220	730 (650 + 80)				
Depth (mm)	250	1900				
Weight (kg)	3.34	~150				
Power supply - single phase (VAC)	230					
Frequency (Hz)	50 - 60					



ATEX MARKING:

Inorecip V & Inorecip H
 CE II 3 D Ex h IIC T135° C Dc

Inomotion
 CE

Inorecip V & H

Inorecip V & H is classified as category 3 according to the ATEX 2014/34/EU directive and is designed for use in zone 22. For Inorecip H, the front part is implanted in zone 22 and the rear part is out of zone.

Inorecip

THE EQUIPMENT

The **Inorecip V** reciprocator is designed to equip automatic powder coating installations.

It is composed of a mechanism controlled by an Inomotion control module placed in an electrica cabinet.

It allows to drive, with a vertical reciprocating movement, powder projectors, for example:

- 12 **Inogun A** powder projectors,
- 4 **Inobell** powder projectors.

The **Inomotion** control module allows to remotely control the vertical reciprocating mechanism of the Inorecip V and the horizontal positioning of the **Inorecip H** (option).

It is connected by power and control cables to the box located at the rear of the **Inorecip V**.

Inorecip H (option)

The In and Out carriage Inorecip H is an unit placed under the Inorecip V reciprocator giving it the possibility to move along a second horizontal axis.

The Inorecip H allows to keep a constant coating distance whatever the width of the parts. It is controlled via the Inomotion control module, which receives information from the part width detection system.

This second axis is also often used for the automatic cleaning mode of the projectors.

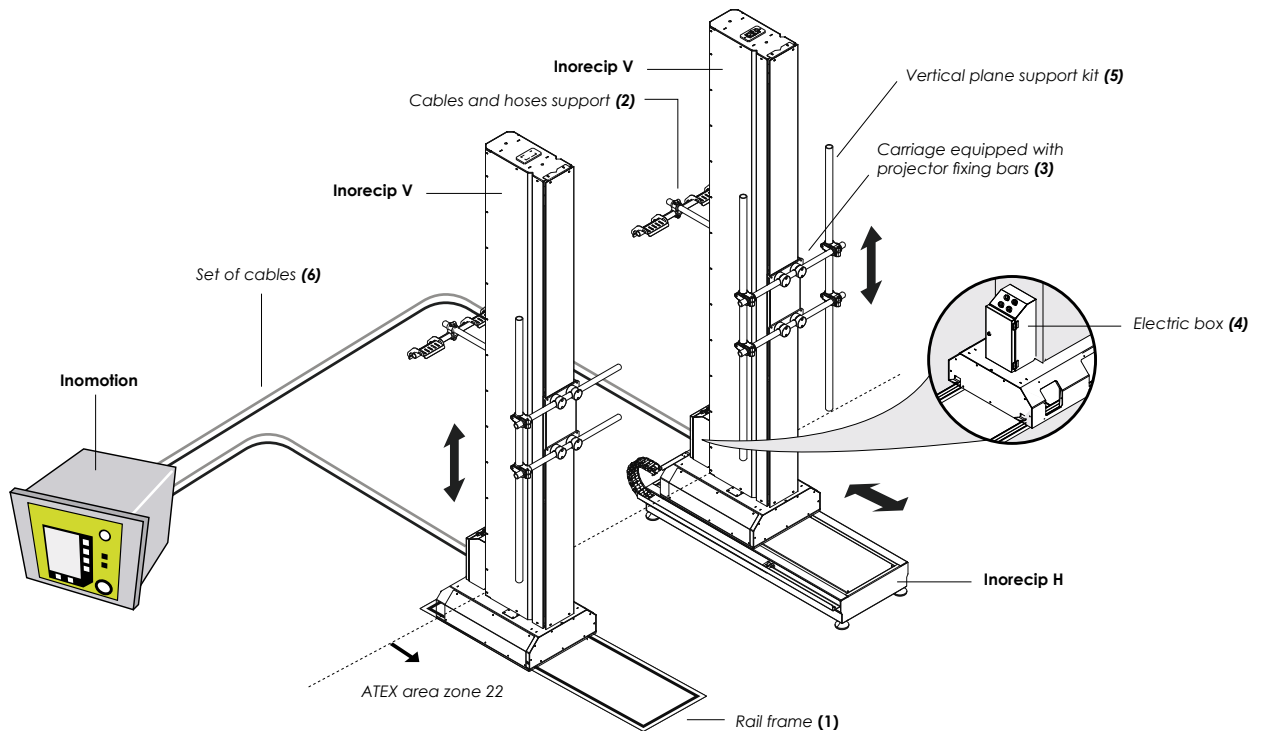

MECHANISM OF THE ROBOT «INORECIP»

Description	Effective stroke (cm)	Part Number
Equipped Inorecip V	180	130002072-180AT
	120 < xxx < 270	130002072-xxxAT
Inomotion	control up to 8 axes	130002073
set of 2 electric control cables (6)		130002076

It is best to choose a standard mechanical robot (180 cm stroke), even if the stroke is greater than the height of the pieces to be painted, it can adapt to space constraints.

Equipped Inorecip V integrates (1-axis):
Inorecip V + x1 rail frame (1) + 1 cables support (2) + 2 projectors fixing bars dia. 40mm (3) + 1 electrical box (4)

COMPONENTS

Description	Part Number	
Vertical plane support kit (5) (2 nuts dia. 40/50mm + 1 bar of 2 meters in dia. 50mm)	910031501	
Fixing nut	Ø50/30 mm.	749805
	Ø50/40 mm (qt = x2)	200000412
Aluminum tube D: 50	length 2200 mm	900001079

Description	Part Number
Inorecip H	130002074AT

Inoprofile



Self-positioning of the projectors according to the shape and size of the part to be painted. It is scanned with two 3D shape sensors when entering the spray booth and is ideal for productions.

- Quick and modular (independent arms)
- No trajectory presets – self adaptive motions
- Less pre-touches and/or touch-ups

TECHNICAL DATA

Inoprofile	Version 1 (booth height 3000 mm max.)	Version 2 (booth height 3500 mm max.)
Length (A) (mm)	2010	2010
Frame length (B) (mm)	1632	1632
Booth height (C) (mm)	3000	3500
Total height (D) (mm)	3300	3800
Booth support width (E) (mm)	680	680
Floor width (F) (mm)	650	650
Stroke adjustment	1200 mm	
In and Out arm movement speed	adjustable continuous, max. 18 m/min.	
Empty weight approx.	100 kg	
Weight per In and Out arm	15.5 kg	
Projector fixing flange	Ø 40 mm	
Motor data		
Supply voltage	48 VC	
Current	3.5 A	
Torque	1.44 Nm	
Operating temperature	+0° C - 40° C	

Inoprofile integrates up to 8 independent projectors

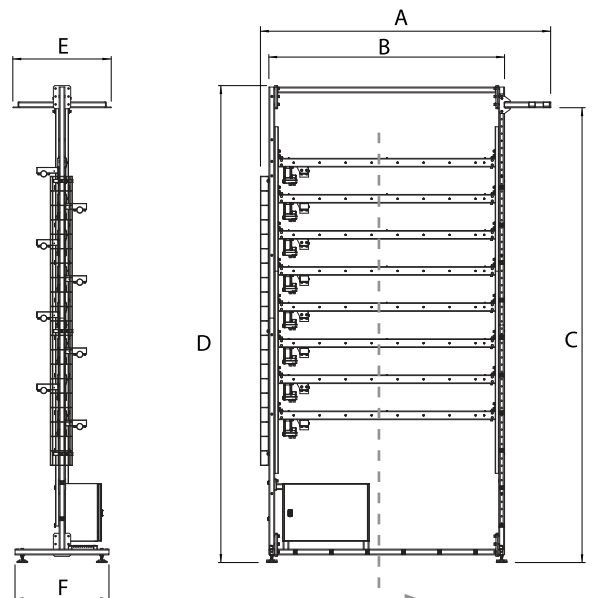

The front part is implanted in ATEX area zone 22 and the rear part is out of zone.

MECHANISM OF «INOPROFILE»

Description	Part Number
Inoprofile	Contact us

ATEX MARKING:

Inoprofile

CE  II 3 D Ex IIIC T85°C Dc

Inoprofile

SYNOPTIC INSTALLATION OF INOMASTER SYSTEM

Inoprofile is a new concept which allows the powder projectors to be sprayed and adjusted around the external profile of the part to be painted automatically. The Projectors move independently of each other which makes the coating modular and ensures deep penetration into recessed areas.

THE BIG ADVANTAGES ARE:

- Less manual operations in the pre-touch up and touch-up areas,
- Part profile monitoring,
- No additional technical skills for operators or handling of projectors,
- Low cost installation on production line with little space requirement,

FUNCTIONING PRINCIPLE:

The part to be painted is scanned with two 3D shape sensors at the entrance to the powder coating booth of the production line. Then the projectors are positioned automatically according to the shape and size of the part to be painted detected.

Step 1 : The part is scanned with two 3D shape sensors when entering in the spray booth.

Step 2 : The part profile is measured

Step 3 : Real time self positioning adjustment of each gun when spraying.

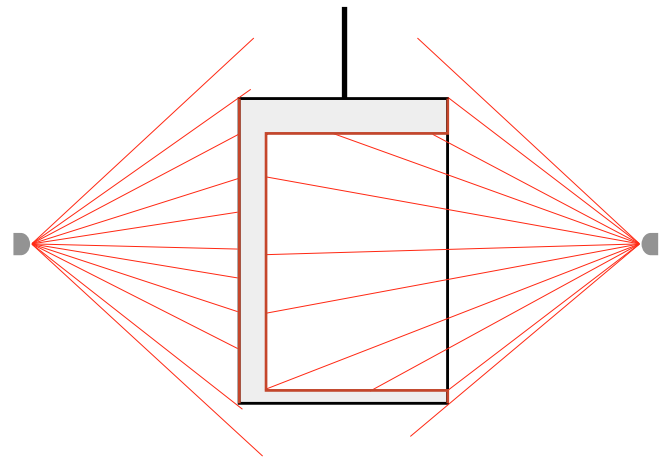

Inomaster



The Inomaster cabinet is intended to supply and control a powder coating installation in a ventilated booth.

The Inomaster cabinet manages the following functions:

- It is designed to install up to 8 Inobox control modules and one Inomotion control module (option).
- Auxiliary pneumatic power supply (with powder tank for example).
- Monitoring of low powder level in the tank.

THE EQUIPMENT

The standard Inomaster cabinet, used in conjunction with its various modules, controls the following functions:

- the installation of 19» standard control racks (not included).
- a power supply module **(1)**
- a Inogun cleaning control module **(2)**
- a Inomotion control module - option **(3)**
- up to 8 Inobox control modules - option **(4)**
- a pneumatic supply kit

The module **(1)** is installed at the top of the Inomaster cabinet above the modules. It is fixed in the cabinet by four screws. This module (P/N: 900002782) is rackable 19 inches and 3U high.

This module **(2)** is installed below the power supply module and above the Inobox modules. It allows the control of the cleaning of the Inogun projectors.

The Inomotion control module **(3)** allows remote control of the Inorecip V reciprocator. It is connected by power and control cables to the cabinet at the rear of the Inorecip V.



TECHNICAL DATA

Designation	Inomaster	Power Supply module
Air Supply Pressure	7 bar (+/- 1)	-
Maximum flow rate	100 Nm ³ /h	-
Maximum consumption in auxiliary air	50 Nm ³ /h	-
Maximum consumption per Inobox	6 Nm ³ /h	-
Height	2000 mm	173 mm (4U)
Connection	3/4" barbed fitting for air hose	
Width	600 mm	483 (19 inch rackable)
Depth	600 mm	-
Approximate weight (without powder)	87.5 kg	-
Protection index	IP20	
Power supply	Single-phase 230 VAC / 50 Hz - 60 Hz	
Maxi input current consumption	16 A	3.2 A
Output voltage	-	24 VDC
Trigger control	-	8 simultaneous

Inomaster

INOMASTER INSTALLATION RANGE

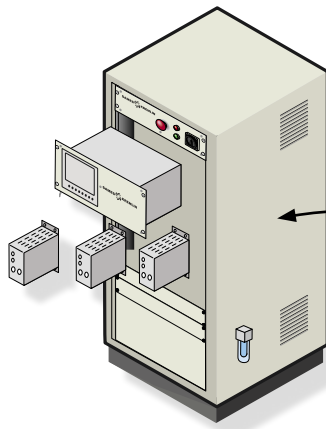

Inomaster

Inomaster Gold

Inomaster Platinum

Inobox

Control cabinet for simple powder coating systems. This version can control and transfer powder up to 8 guns and 2 Inorecip V. Front panel control by Inobox module.

+
Options*

Inocontroller

Control cabinet for powder coating systems for guns and powder turbines over 8 (max. 24) as well as Inorecip reciprocators. Human Machine Interface (HMI) allowing the control and management of the production line.

+
PLC
+ **HMI 7"**
+
Options*

+
PLC
+ **HMI 15"**
+
Inocenter
+
Inoprofile

SYNOPTIC INSTALLATION

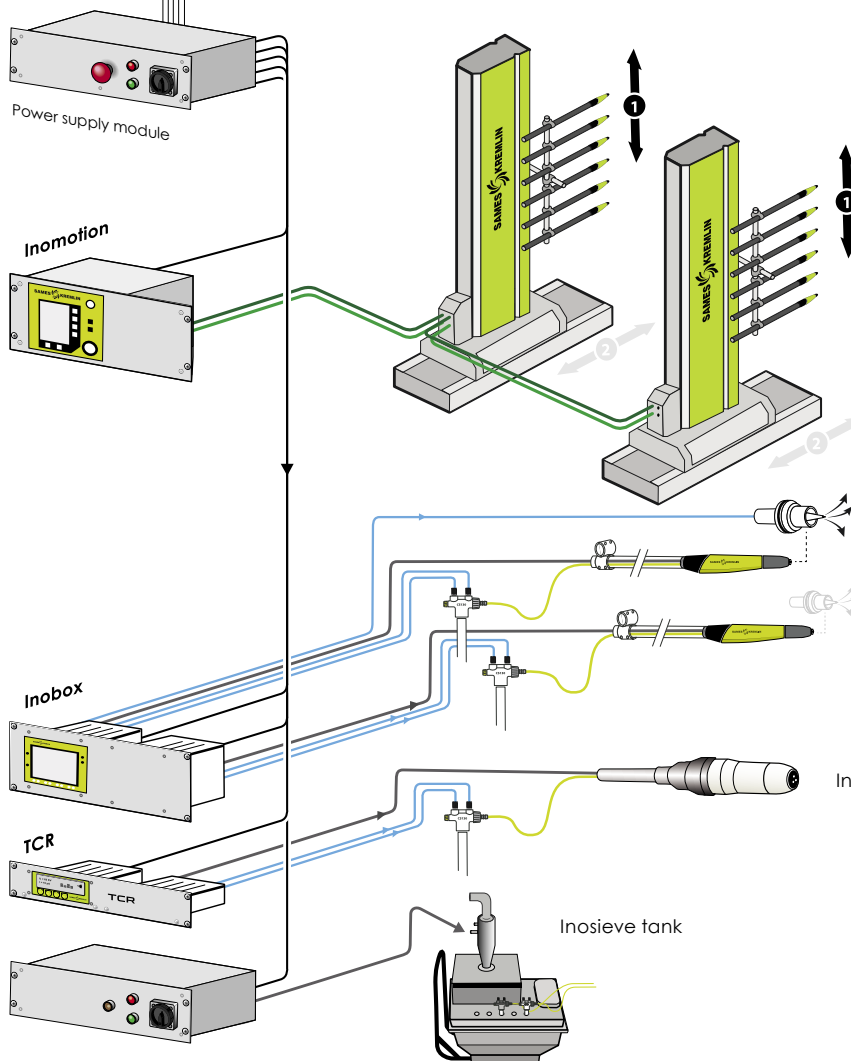
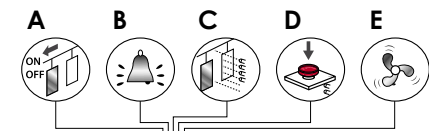

*Option racks:

Inomaster
up to 2 Inorecip V (Inomotion)
Powder tank & Inosieving controller
Powder feeding with Inotransfer
Powder reclaiming

Inomaster Gold
Compatible with Inobell TCR control module
up to 2 Inorecip V and 2 Inorecip H (carriage)
3D part detection
Powder tank & Inosieving controller
Powder feeding with Inotransfer
Powder reclaiming

Blowing electrode pneumatic

Inogun A / Inogun A FCC sprayer

Inobell sprayer

Inosieve tank

interfaces with the paint shop:

- A:** Input/Output - Conveyor operation
- B:** Input/Output - External fault
- C:** Input - Part detection
- D:** Input - Emergency stop
- E:** Input - Ventilation operation

CS130

Feeding system for powder paint.



- **Powder flow up to 24 kg/h** (it depends on the type of powder hose)

ATEX MARKING:

CS130
 CE  II 3 D c T 85°C

CUSTOMERS' BENEFITS

- Design without retention for optimal color changes. Strength of the body thanks to the clamping, no deformation.
- Easy to use, quick maintenance and no special tools required.
- Access to the ejector without removing the tip of the powder hose.

- Quick air coupling connectors with color-coding and keyed connection.
- Metal body and injector allowing solvent rinsing.
- The conductive output tip improves the evacuation of the triboelectric charges that may be generated.
- Quick clamping system with a uniform distribution regardless of the number of powder pumps.

POWDER PUMPS

Description	Reference
Male union, dilution air dia.6mm	130001142
Female union, injection air dia.8mm	130001143
↓	
CS130 alone - POWDER VERSION (injection & dilution)	910013775
CS130 alone - AIR VERSION (injection air)	910014333
↓	
Plunger tube	
for Inocart VT	910025252
for Inosieve / Inotank⁽¹⁾	1526399

(1): The length of the plunger tube is suitable for Inosieve and Inotank, please cut the tube according to the powder container used, this referred to the user manual n°716 or contact us.

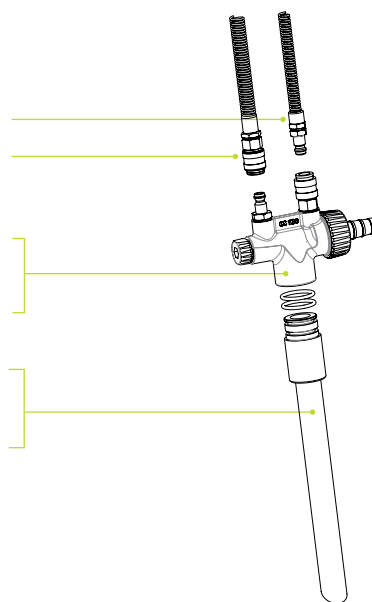

POWDER COMPONENTS CS130

Description	Item	Reference
Metallic air injector	A	910014564
Plastic air injector	A'	910014565
Red washer 1/8	B	EU9000853
Quick release connector 1/8" BSP	C	EU9001083
Releasable connector 1/8" BSP	D	F6RAJR025
Blue washer 1/8	E	EU9000854
Venturi tube assembly	F - Grey	910014388
	Option white	910014390
O-ring-Black viton	G	J2FTDF273
Anti-static outlet tip	H	900008907
Connection nut	I	900008904

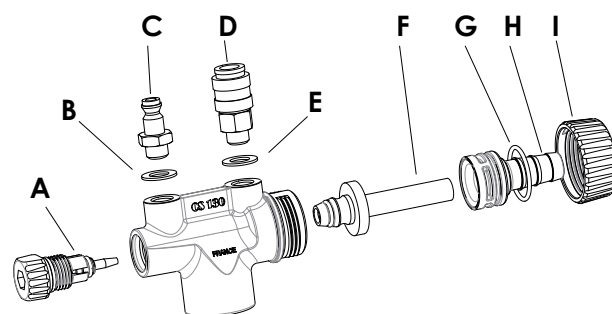

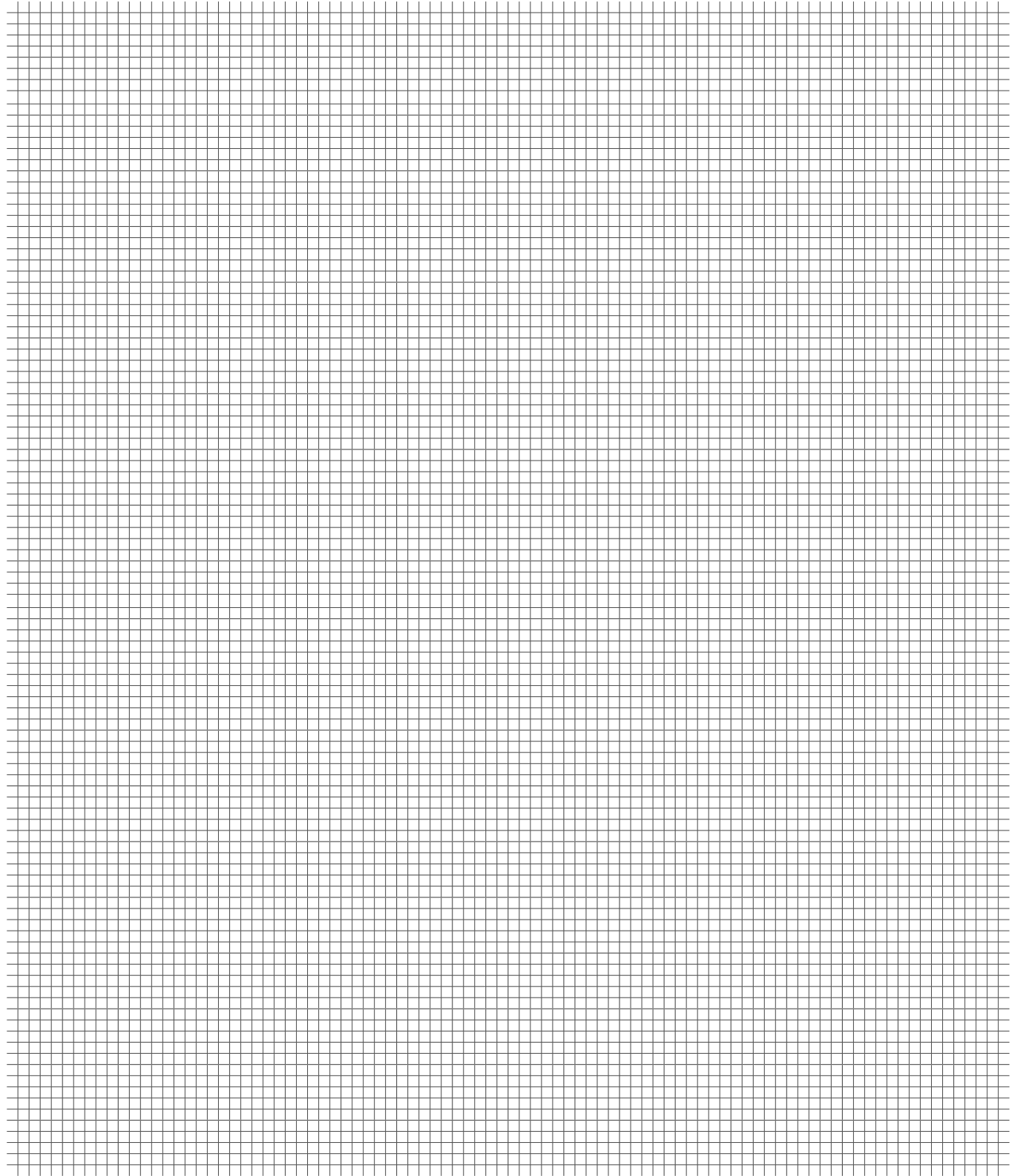

Inotransfer

The Inotransfer powder transfer pump is designed for the transport of powder paint, ideally for an automatic powder coating plant, to supply new powder to a fluidized bed tank (eg: powder feed center). It can also be used for the evacuation of recycled powder, such as hopper bottom, tank bottom, etc...



- High transport rate = 300 kg/h
- Long distance transport = 25 m
- Low air consumption
- Integrated cleaning function
- Easily handled using the trolley

TECHNICAL DATA

Designation	Inotransfer		
Quick-release coupling	Diam. 8 mm		
Inlet pressure	7 bar +/-1		
Air consumption in pump mode	450 NI/min		
Air consumption in cleaning mode	630 NI/min		
Box dimensions (W x D x H)	400 mm x 210 mm x 510 mm		
Weight	39 kg		
Supply voltage	100 -240 VAC		
Frequency	50 - 60 Hz		
Vibrator control voltage	100 - 240 VAC single-phase		
Max. vibrator drive power	50 W		
Operating temperature	0° C - 40° C		
FLOW PERFORMANCE	(*) USE EXAMPLE 1	(*) USE EXAMPLE 2	(*) USE EXAMPLE 3
Suction hose length	4	6	6
Ourput hose length (m)	6	25	25
Operating cycle (s)	0.5	0.5	2
Pression de soufflage (bar)	0.8	2	3/5
Flow rate (Kg/min)	5.5	5	5.5
Sleeve control pressure (bar)	4	4	5

(*): The powder flow rate measurements are given as an indication because they depend on several parameters, suction distance, output distance, density of the powder put in motion, height difference, container, etc...

Flow rate (4 m suction, 6 m output, 1m height difference) 5.5 Kg/min.

Inotransfer

DESCRIPTION

For optimum efficiency, the Inotransfer transfer pump must be installed as close as possible to the container to be drawn from and out of the explosive area. The pump must be installed vertically and the circulation of the powder must be from top to bottom.

Select the operating mode (blowing or pumping) with switches on **control module (1)**.

Prior to start-up the **Inotransfer (2)**, the drawing **rod (3)** must be connected to the transfer pump by a transport hose of a length defined by the user. The suction is done from the top of the pump, the delivery is done in the lower part.

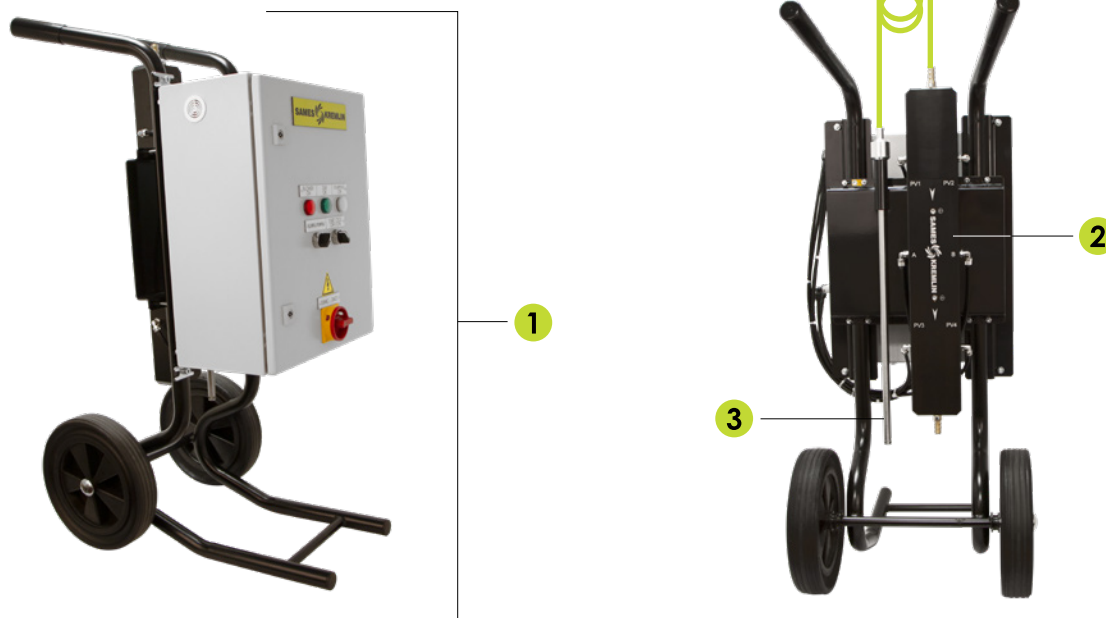

POWDER SYSTEM

Description	Mark	Part Number
Inotransfer assembly (**)	1	910029983

(**): included the inotransfer pump, the trolley, the control box, the suction rod and a powder hose (Dia.13mm - 10m)

COMPONENTS

Description	Mark	Part Number
Transfer pump only	2	910023986
Suction rod assembly (***)	3	910029984

(***): included a pipe dia.13mm of 10 meters, allowing a connection for transport between the suction pipe and the pump inlet.

Inotank – Inosieve – Vibrating table

The tank range Inotank has also been completely renewed. New high end materials, more flexibility with different capacities will match all needs, for laboratories, or medium size automatic solutions.

Powder feed systems come in three categories:

TANK

Each **Inotank** is made up of:

- A bottom equipped with a porous fluidization plate.
- A body fixed on the bottom either by means of snap fasteners or collars.
- A cover supporting the plungers, from 1 to 20 according to the model.
- A filling trap allowing to control the powder level for the 50L, 100L and 150L versions.

As an **option**, the 100 l and 150 l tank versions can be equipped with a powder level sensor:

- A low level of powder to prevent missing powder.
- A high level that allows to control the filling when it is managed automatically via a transfer pump.



Inotank 8 L. = 1 pump
Inotank 50 L. = 2 pumps
Inotank 100 L. = 12 pumps
Inotank 150 L. = 20 pumps

SIEVING UNITS

Each **Inosieve** is designed on the basis of the **Inotank** in 100 L and 150 L versions and completed by a sieving set composed of:

- A bottom equipped with a porous fluidization plate.
- A body fixed on the bottom either by means of snap fasteners.
- A cover supporting the plungers, from 12 to 20 according to the model and a sieve body
- A sieve body equipped with an electric vibrator and a 250 micron sieve mounted on silent blocks.
- A filling trap allowing to control the powder level.
- A minicyclone to select recycled and new powder.

As an **option**, these Inosieve can be equipped with a powder level sensor:

- A low level of powder to prevent missing powder.
- A high level that allows to control the filling when it is managed automatically via a transfer pump.



Inosieve 100 L + sieve 250 microns
Inosieve 150 L + sieve 250 microns

VIBRATING TABLE

The vibrating tables allow to support containers of new powder intended to **continuously** feed distribution tanks (or Inosieve or powder feed central).

The containers, 20 kg boxes or 200 L barrel depending on the model, are vibrated in order to facilitate the flow of the powder during the pumping phase.

And another version of a vibrating table allowing to receive boxes of 20 kg with a powder suction rode equipped for use directly towards a powder projector (eg: Inogun A)



Powder feed for spraying
Vibrating table for 20 kg box

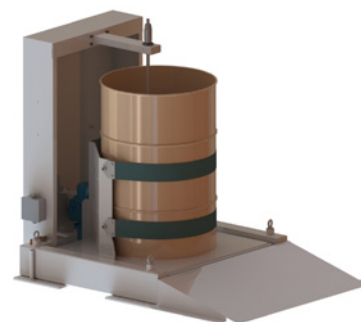

Powder feed for dispensing
Vibrating table for 20 kg box
Vibrating table for 200 L barrel

TECHNICAL DATA

Designation	Inotank				Inosieve		Vibrating table	
	8 L	50 L	100 L	150 L	100 L	150 L	20 kg	200 L
Powder capacity (kg)	4	20	40	60	40	60	-	-
Diameter or length (mm)	250	390	1014	1266	1014	1266	-	-
Width (mm)	-	-	599	599	599	599	380	110
Height (mm)	465	636	1150	1150	1410	1410	703	1200
Length (mm)	-	-	-	-	-	-	530	1555
Empty weight (kg)	4	10	110	130	115	135	19	190
Maximum number of plungers	1	2	12	20	12	20	1	2
Max fluidization flow rate (Nm3/h)	1	2.1	4	5.5	4	5.5	-	-
Diameter of the fluidizing hose (mm)	8	8	8	8	8	8	-	-
Diameter of smoke exhaust duct (mm)	-	30	60	60	60	50	-	-
Vibrator supply voltage	-	-	-	-	220 VAC			
Frequency (Hz)	-	-	-	-	50			

ATEX MARKING:

Inotank 8 LT; Inotank 50 LT; Inotank 100 LT; Inotank 150 LT



Inosieve 100 L; Inosieve 150 L



Vibrating table 20 L



Vibrating table 200 L



POWDER COATING FEED EQUIPMENT

Description	Model	Part Number
Inotank	8 L.	130002068AT
	50 L.	130002065AT
	100 L.	910031487
	150 L.	910031488
Inosieve	100 L.	910031384
	150 L.	910031385
Vibrating table	for 20 kg box with a powder suction rode	910030923 (1)
	for 20 kg box	910029985 (2)
	for 200 L. barrel	910031737

(1): vibrating table used for feeding powder to a sprayer, a suction rod is equipped

(2): vibrating table used for dispensing powder to another destination (eg: new powder feed for a powder feed central)

OPTION

Description	Model of sensors	Part Number
Sensor support kit	Low	910031503
	High	910031502

The detection sensors provide information on the powder level in the tank and are compatible with the Inotank and Inosieve systems.

In the case of automatic filling, provide the 2 models of sensors:

- high level to detect maximum filling
- low level to detect when the tank is empty

Engineering solutions

SAMES KREMLIN offers a **wide range** of automatic powder coating **system**:

INOBOOTH



FOR RANDOM PRODUCTION & MANY COLOR CHANGES:

- **Dedicated for quick color change installations**
- Modular design, assembly carried out without welding: quick installation, no skill required for welding
- Booth is small: quick cleaning from outside
- 100% automatic application
- Option of a platform for pre-touching or manual retouching on 1 side of the conveyor
- Compatible with the new Inoprofile system

PVV EasyCompact



FOR INTEGRATED PRODUCTION & INTENSIVE TOUCH-UP:

- **Dedicated to meet the application of complex parts**
- Booth is compact: quick cleaning from outside
- 2 separated areas: Automatic & Manual
- Flat floor for 2 manual areas: side protection fences
- Separated air flow between manual and automatic areas

PVV EasyColor



FOR INTEGRATED PRODUCTION & EASY PARTS:

- **Dedicated to large parts to be painted**
- Compatible with the use of a multi-axis robot
- Booth is modular: Designed to meet customer needs
- Access door for manual coating on simple parts
- Flat floor with hopper
- Very wide pieces
- Compatible for floor or overhead conveyor
- 100% automatic application and/or 1 pre-touch or 1 touch-up



Engineering solutions

Booths range incorporates many **shared features**:

1 - BOOTH MADE FROM COMPOSITE MATERIALS

- Honeycomb structure,
- No powder build-up on walls and the bottom of the booth,
- Vertical downflow with low velocities in the paint application area for improved transfer efficiency,
- High air speeds at the level of the booth entrance and exit silhouettes to limit powder discharge outside the booth,
- Easy cleaning using compressed air,
- INOBOOTH : Blowing floor for continuous recirculation of recycled powder, saving time for color changes,



2 - PARTS DETECTION

- The part to be painted is scanned with two 3D shape sensors
- Optimization of gun triggers
- Adapt distance between gun and part
- High levels of application process automation
- New solutions for powdering complex objects
- Optimized coating quality and powder savings and reduced overspray

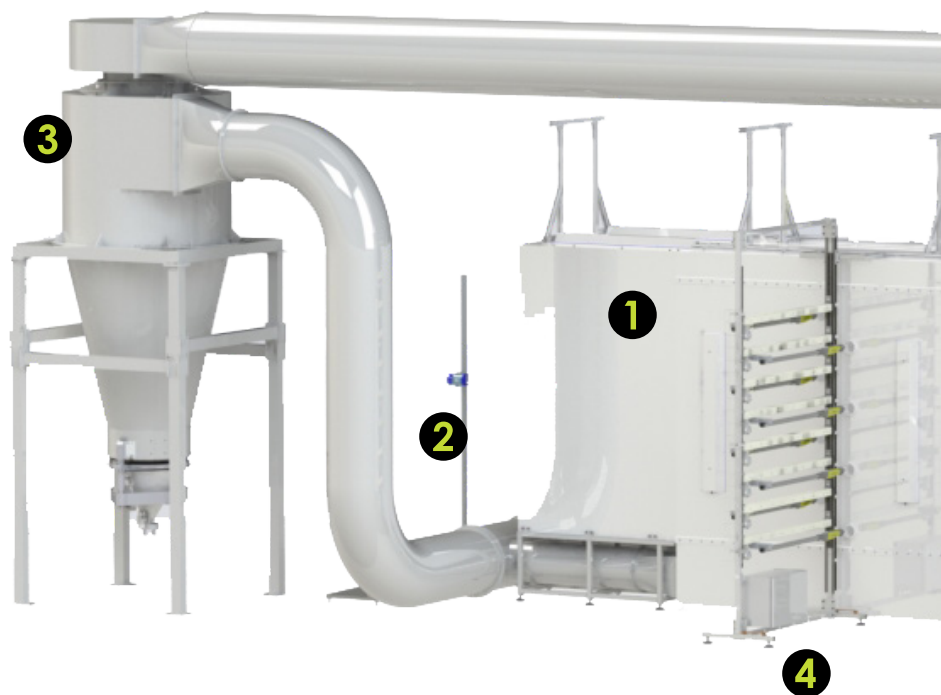

3 - CYCLONE WITH FILTER

- The cyclone/sieve set allows the recovery of powder overspray.
 - High efficiency
 - Continuous sleeve valve recycling
 - Sieve to recover the powder:
- Very efficient and durable, the perforated plate is fitted between the base of the cyclone and the sieve.

4 - QUICK COLOR CHANGE

- A compressed air network automatically cleans :
 - Powder hoses to the sprayer
 - Sprayers bodies
 - Cyclone & sieve
 - Recycled powder circuit
- Lead from main control panel
- Between 10 and 15 minutes on average

Engineering solutions

5 - CENTRAL CONTROL PANEL

- Large touch screen for controlling the installation,
- Total production management,
- Preventive maintenance management,
- Assistance with the cleaning procedure,
- Profinet communication network between the different devices (reciprocator, detection, projector module, PLC),
- Optional modem for remote connection and assistance.

6 - FILTER GROUP

It controls the quality of the air expelled either inside or outside of the workshop as required. Its anti-clogging control system checks the water column permanently. This method preserves good speeds inside the powder coating chamber, whilst ensuring long life for the filter cartridges.

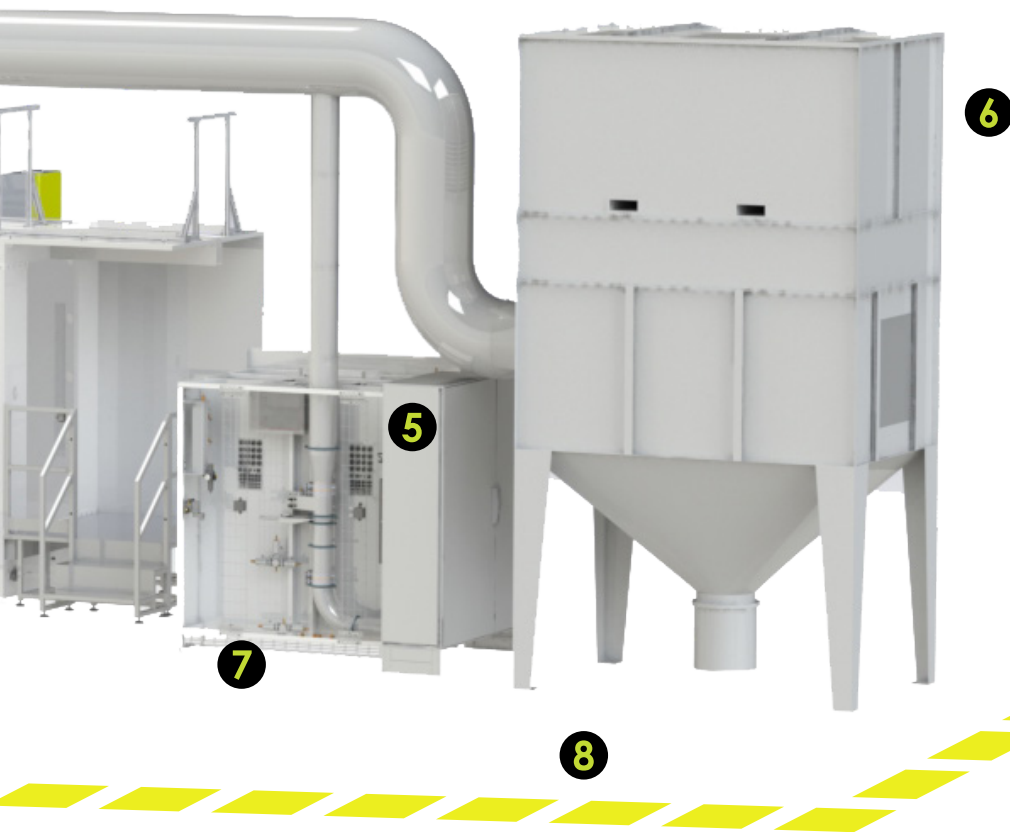

7 - POWDER FEED CENTER

- Feeding up to 24 pumps,
- Quality of the color change, 99% powder reclaimed for powder savings,
- The same Inocenter fits all types of powder containers from 20 to 1000 kg production needs, from small batches to large campaigns,
- Automatic pump & hoses cleaning,
- Complete color change in 10 minutes: fast color change, small batch work,
- Possible retrofit on existing line,
- Reduced maintenance = no filter cartridge in the central unit and recovery of the powder lost in the general group.

8 - MODULAR DESIGN TO ANSWER ALL NEEDS

- Variable lengths and heights of our booth models (EasyCompact, EasyColor and Inoboath),
- Number of sprayers and ventilation are sized depending on project,
- Modular design, adaptive to production needs and increase.

Engineering solutions

Systems of powder installation

Allows your customers to increase their productivity by modernizing their automatic powder installation. All elements which compose our different powder coating booths are independently available. You will be able to integrate them on your customer's existing line or on brand new lines.

1 - BOOTH MADE FROM COMPOSITE MATERIALS

1 need => 1 suitable model
The range of powder coating booths meets a wide demand for the dimensions of parts to be painted.

Booth dimensions		Easycompact		EasyColor	Inoboath
		Standard	Large		
Height H (mm)	Maxi.	4000	4000	4000	2500 -> 4000
	Mini.	2500	2500	2500	
Length L (mm)	Maxi.	3850	4450	6000	2500
	Mini.	-	-	3000	
Width I (mm)	Maxi.	1700	2100	2500	2200
	Mini.	-	-	1200	1700

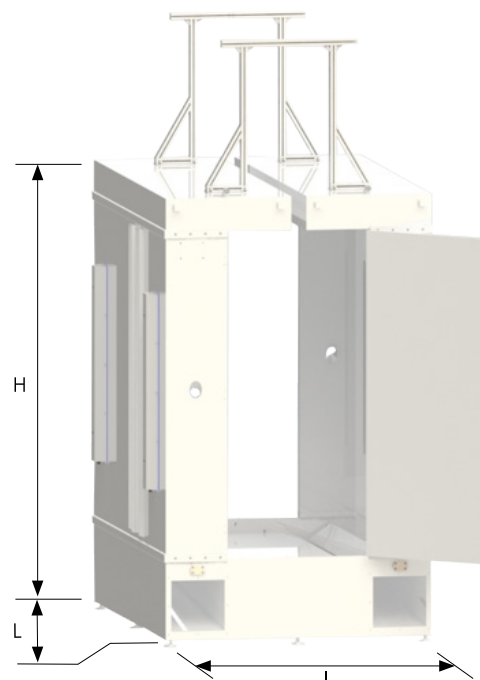

2 - PARTS DETECTION

Detection of parts to be painted by 3D laser scanner allowing shape recognition.

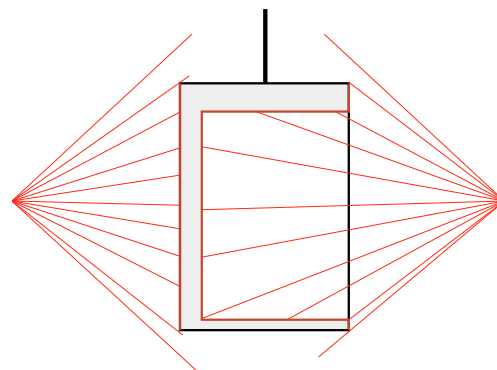

Parts sizes		EasyCompact & Inoboath	EasyColor
max. Width (mm)	Standard	800	-
	Large	1200	1600
max. height (mm)		2500	3000

Engineering solutions

3 - EXTRACTION CYCLONE

Air/powder separator thanks to the centrifugal force ensuring a high recycling yield. The cyclone/sieve set allows the recovery of powder overspray. The recycling system (sleeve valves) ensures the powder transfer from the sieve to the powder center. A perforated plate makes it possible to «break» the speed of arrival of the powder on the sieve and thus to prolong the life of the latter.

This determines the output of the installation. Its form and diameter are calibrated to suit the context of the installation to guarantee very good separation performances. The built in sieving system is patented and combines fine filtration and high flow rate.

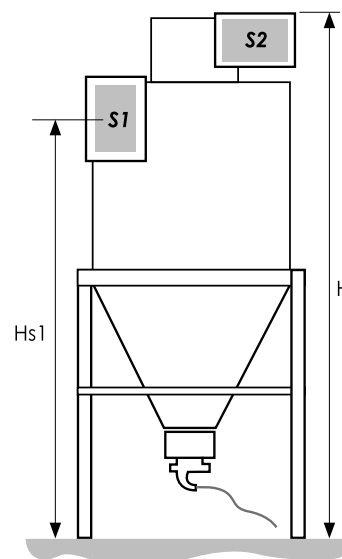
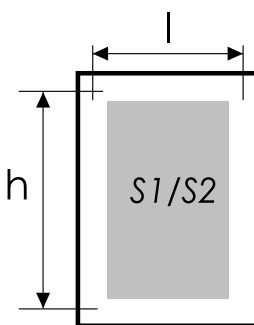

TECHNICAL DATA OF CYCLONES:

	Air flow (m ³ /h)						
	9000	12 000	16 000	20 000	24 000	28 000	32 000
«S1» air input section l x h (mm)	262 x 377	256 x 411	296 x 556	356 x 606	366 x 686	373 x 692	514 x 864
«S2» air output section l x h (mm)	400 x 298	451 x 359	505 x 402	567 x 451	643 x 512	714 x 568	741 x 602
«H» Height on frame (mm)	4110	4520	4971	5988	6184	6228	6268
«Hs1» Height (mm)	3377	3707	3948	4938	5013	5066	5066
Frame dimensions (mm)	1360 x 1360	1465 x 1465	1610 x 1610	1830 x 1830	2010 x 2010	2210 x 2210	2410 x 2410
Weight (frame included) (kg)	660	750	860	1080	1170	1360	> 1360

TECHNICAL DATA OF THE POWDER SIEVE AND CONTROL MODULE:

Powder flow max.	150 kg/h
Box supply voltage	24 V - DC
Vibrator supply voltage	380 VAC Tri
Supply pressure	6 bar (87 psi) +/- 1 bar (14,5 psi)
Size of sieve screen	250 µm / 390 µm

Engineering solutions

4 - SPRAYERS BLOWING

When changing over colors, the Inogun A-FCC or Inobell can be cleaned easily, automatically and quickly with an airblowing system.

The use of an **Inorecip V** reciprocator on the horizontal axis (forward and backward) allowing cleaning, is possible with the **Inorecip H** option (refer to the *Inorecip* chapter on page 38).

Inoprofile solution is also equipped with a dedicated nozzle for guns cleaning optimization.

The automatic cleaning system is then controlled either by the Inomotion control module for a standard installation or with our new HMI interface from a PLC controller for Inomaster Platinum type installations.



5 - CENTRAL CONTROL PANEL

Installation control HMI (Inomaster Platinum)

- Large touch screen for controlling the installation
- 4 operating modes
- Profinet communication network between the different devices (reciprocator, detection, projector control modules, PLC)
- Production management page to allow preventive maintenance
- Assistance with the cleaning procedure
- Optional modem for connection and remote assistance

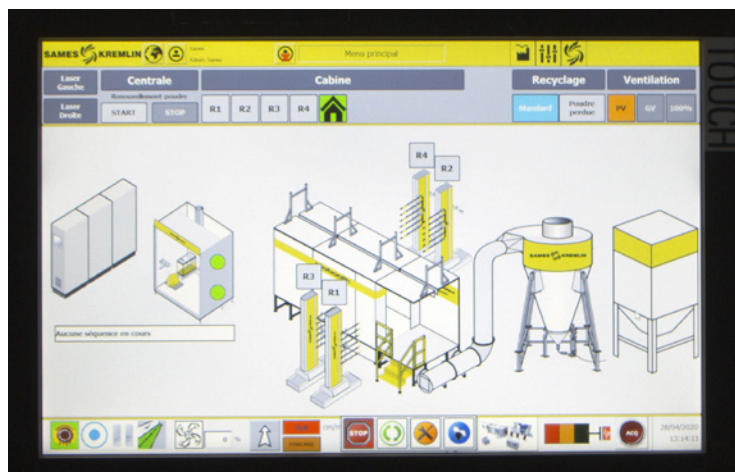

Engineering solutions

6 - FILTER GROUP

Ventilation boxes with compressed-air automatic cleaning, are especially designed for filtration and separation of powder paint. They guarantee a highly effective filtering.

Air flow provided by the filter box is comprised between 10 000 m³/h and 22 000 m³/h (to choose according to dimensions of the booth openings and the quantity of projected powder).

The filters are delivered in 3 sub-assemblies:
fan block + filter block + hopper

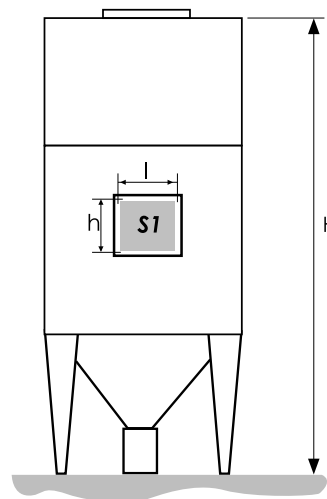

GROUPS OF FILTRATION DATA:

	Air flow (m ³ /h)				
	10 000	12 000	16 000	20 000	22 000
«S1» air input section l x h (mm)	800 * 250	2 * 800 * 200	2 * 800 * 250	2 * 800 * 250	2 * 350 * 800
«H» Height on frame (mm)	4108	3889	4364	4364	4177
Frame dimensions (mm)	1475 * 1050	2000 * 1475	2000 * 1475	2000 * 1475	2000 * 2351
Weight (kg)	1215	1580	1890	1890	2240
Fan unit length x width x height (mm)	1561 * 1486*1153	2011 * 1486 * 1406	2011 * 1486 *1406	2011 * 186 *1406	2011 * 2362 * 1046
Filter block length x width x height (mm)	1475*1050*2255	2000*1475*1780	2000 * 1475 * 2255	2000 * 1475 * 2255	2000 * 2351 * 1930
Hopper length x width x height (mm)	1475*1050*703	2000*1475*703	2000 * 1475 * 703	2000 * 1475 * 703	2000 * 1930 * 841
Number of cleaning valves	8	12	16	16	24
Filtering surface (m ²)	168	252	336	336	504
Nominal fan power (kW)	15	22	30	37	45
Nominal static pressure (Pa)	3600	4900	5000	4250	5650

ATEX MARKING:

II 3D Ex h IIIC T200°C Dc

Engineering solutions

7 - POWDER FEED CENTER

The INOCENTER is a fast color change powder center, with a low capacity fluidized hopper feeding up to 24 guns, ideal for small batches work.



- **Complete color change in 10 minutes: fast color change, small batch work.**
- **Quality of the color change, 99% powder recovered: more powder savings.**
- **Modular design: adaptive to production needs and increase.**



- 1 - Powder pump
- 2 - Powder tank,
- 3 - Vibrating table,
- 4 - New powder supply plunger
- 5 - HMI (Human Machine Interface)

The Inocenter powder station is a ventilated powder dispensing enclosure allowing:

- Powder supply to projectors and guns (24 maximum).
- Automatic cleaning of:
 - powder pumps,
 - powder supply hoses,
 - the inside of projectors and guns,
 - powder recycling hose.
 - powder tank.

Without filter cartridge, there is almost no maintenance operation, reducing downtime and running costs. Designed for an easy and flexible integration with the rest of the INOCOAT

Powder and energy savings have been placed at the heart of the Inocenter development to reduce waste emission, enhancing productivity and finish quality of the coating. Should it be used in an advanced powder process or in a very simple and performing powder booth, it is ideally controlled by a single panel equipped with a very friendly and clear interface.

SPECIFICATIONS DETAIL FOR EACH EQUIPMENT

GUN	Inocenter
Weight (kg)	550
Height (mm)	2200
Wdidth (mm)	1800
Depth (mm)	1300
Number of powder guns	24
Intermediate fluidized hopper capacity (L.)	20
Electrical power (V)	110 - 220
Maximum air pressure (bar)	7

ATEX MARKING:

Vibrating table & Tank
II 3 D - Ex tc IIIC T100 C Dc

COMPONENTS

Description	Part Number
Inocenter powder station	910028183

The control unit incorporates: Control and blower terminal boards PN **910029605**; Transfer pump management board PN **910028861**; Ventilation duct assembly PN **910027665**; Inotransfer pump PN **910023986**; New powder supply sleeve valve assembly PN **910028081**; Recycling sleeve valve assembly PN **910028082**; Solenoid valve assembly for blowing out the tank PN **910028125**; Solenoid valve assembly for distribution cleaning PN **910028124**; Vibrating table PN **910024392**; Tank PN **910027997**; Powder pump (x24) PN **910028786**

Engineering solutions

ATEX zones to consider

According to 1999/92/EC Directive, the ATEX zones' definition is the responsibility of the user. For information, here is an installation diagram in accordance with EN16985 standard booth system, contact **SAMES KREMLIN** for more information.

Zones are defined as follows:

- 1- POWDER BOOTH:**
 - Zone 22** for the inner volume of the booth + **1 meter** around all openings.
 - Zone 22** inside the cabin ventilation duct
- 2 - POWDER FEED CENTER:**
 - Zone 22** for the inner volume of the feed center
 - Zone 20** for the inside of the tank
- 3- CYCLONE AND LINES:**
 - Zone 22** outside the cyclone 1 meter from the hopper
 - Zone 22** inside the pipe between the booth and the cyclone
 - Zone 21** inside the cyclone and the hopper
- 4 - FILTER GROUP AND LINES:**
 - Zone 22** between the cartridge and the fan motor
 - Zone 21** in the filtering part with the cartridges

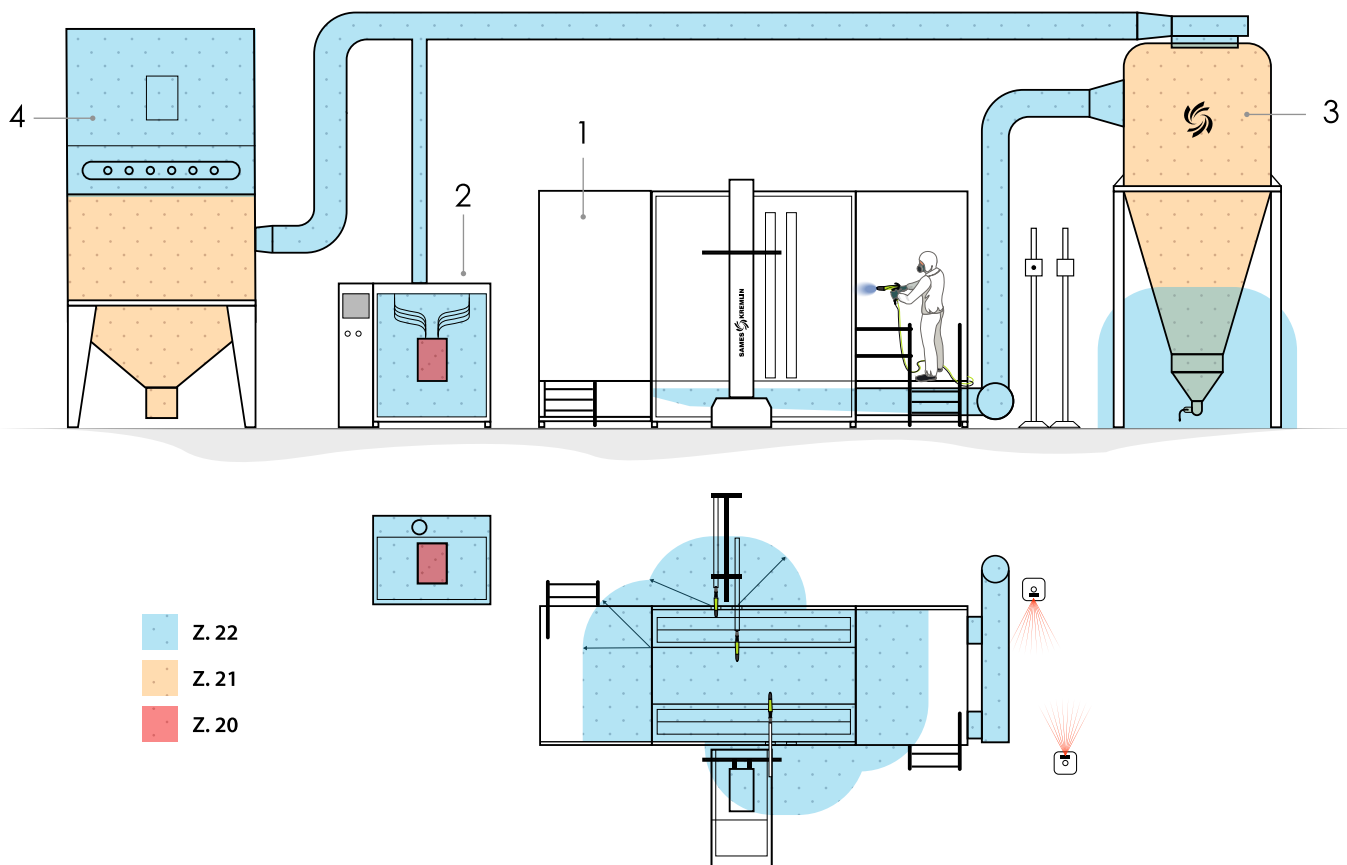

Inoboost

Productivity, compactness, ergonomics are the key words that sum up the current requirements of the surface treatment industry.

To meet these criteria and satisfy the most demanding customers, Sames Kremlin has developed Inoboost.

An automatic powder application solution designed around the booth and complementary to the Easycompact and Easycolor booths, all dedicated for quick color change installations.

Modular in design, the assembly is carried out without welding and does not involve specific skills or equipment for on-site welding.

The composite structure reduces powder retention on the side panels and roof, for a quick and pollution-free color change.

The background is continuously blown during the application phases for a regular supply of recycled powder and a saving in color change time.

Reduced air speeds in the automatic application area to maximize application yield, and high air speeds at the entry/exit silhouettes to limit powder outflow.

This cabin can be used for a 100% automatic application, equipped either with Inorecip, or with our Inoprofile solution, or mixed with Inogun A FCC and/ or Inobell.

It can be optionally equipped with an operator platform for the pre-touches upstream of the automatic structure, and/or at the exit for manual touch-ups.



FOR RANDOM PRODUCTION & MANY COLOR CHANGES

PVV EasyCompact

Optimise your paint line and your production !

EasyCompact can be integrated quickly and easily into new or existing installations; its compact size means that it may be commissioned very quickly.

Its performances for changing over colors will increase your coating productivity significantly, as well as that of the rest of your production, provided that the stages prior to the booth (assembly of parts, surface treatment) and after the booth (hoven) allow it!

The booth gives access to 2 manual rework stations, either BEFORE OR AFTER the automatic station.

Changing over colors becomes quick and easy. The booth is cleaned from the outside, there is no need to go inside it once the manual and double doors have been closed.



FOR INTEGRATED PRODUCTION & INTENSIVE TOUCH-UP



The air flow passes under the floor along the length of the booth through a central opening. This design permits a homogeneous flow inside the booth that satisfies the application and cleaning criteria.

The design of the booth, thanks to its flat floor in the manual zone and the internal separation deflectors, permits the operator to enter sufficiently inside the booth for more ergonomic and cleaner use in production. These deflectors are covered by a patent by **SAMES KREMLIN**, and can be oriented to facilitate cleaning from the outside of the booth.

The two manual powder coating stations and the output area are equipped with swing doors and permit, when closed, a reduction of the opened surfaces of the booth and therefore to increase the air speeds to limit the powder outputs during cleaning operations.



PVV EasyColor

The PVV Easycolor booth is fully modular and great flexibility.

Its composite structure allows colors to be changed over very quickly (10 to 15 min).

The PVV Easycolor system ensures a finish that meets your expectations for industrial requirements.

- Manual and ventilated access to work stations
- Vertical ventilation
- Automatic cleaning function using a pressurised air system that carries out the cleaning:
 - venturi feed pumps.
 - powder hoses and inside of sprayers.
 - a reclaim powder hose.
- The external cleaning of the sprayers is carried out inside the booth
- Flat base that facilitates access for cleaning and maintenance operations
- The central powder supply unit Inocenter is fully automated
- The control cabinet Inomaster Platinum equipped with a color touch screen
- Cyclone with integral sieve and filter preventing the powder from polymerisation



FOR INTEGRATED PRODUCTION & EASY PARTS



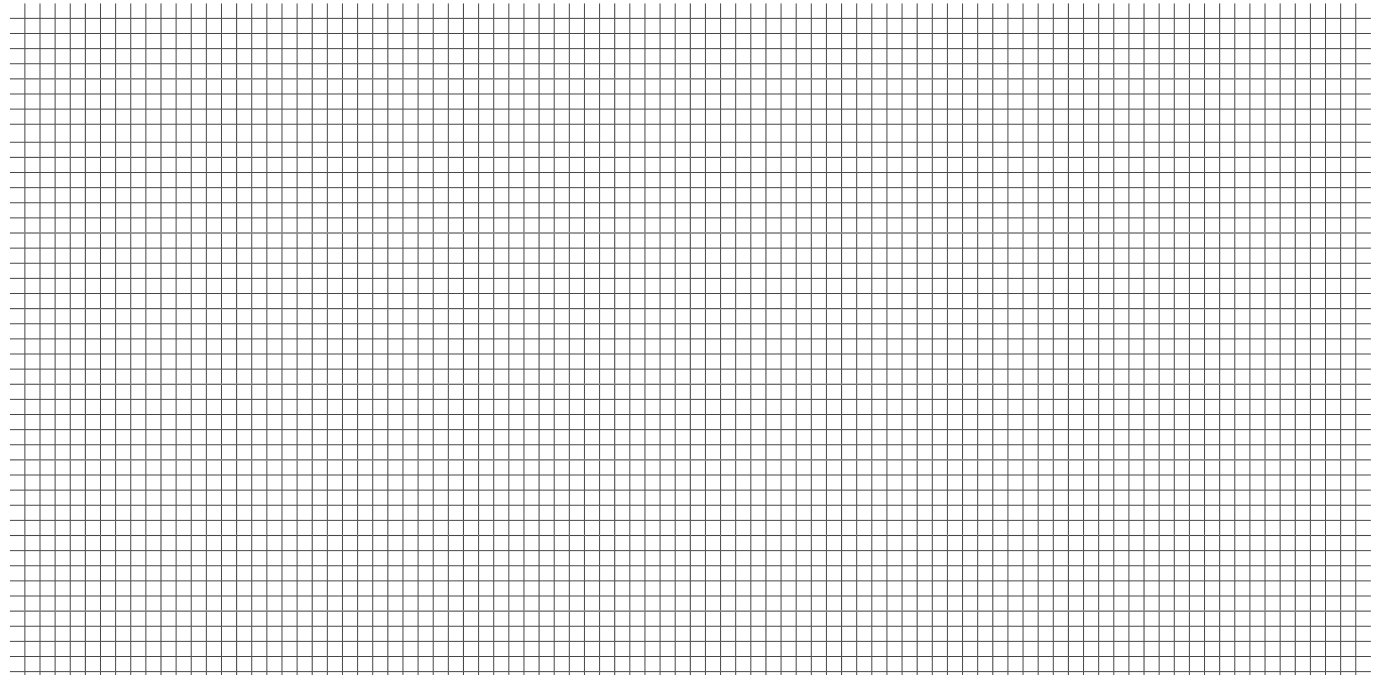

SAMES  **KREMLIN**



HVP500

Measuring device
High voltage probe

- **EASY TO READ DISPLAY:** 4 1/2" digit display
- **PORTABLE:** Protected by a foam lined aluminum case
- **FACTORY CALIBRATED:** HVP500 is calibrated to NIST standards

HVP500 is a precision high voltage probe designed to measure DC voltages up to 100 KV.

HVP500 consists of a removable probe containing high voltage resistors and a 4 1/2" digit display.

The probe resistors are very high resistance to minimize loading of the high voltage being measured.

The removable probe screws into the hand-held base and comes with 2 removable tips - including a ball and a cone.

This portable hand-held unit comes in a foam lined aluminum case that is lockable.



TECHNICAL DATA

Description	Reference
Voltage	0 to ± 100 KV
Accuracy	± 0.1%
Resistance	10 G ohm ± 5%
Stability	100 ppm/ °C
Weight	1 lbs. 11 oz.

Description	Reference
HVP 500	220000326

Not for use in hazardous location.

AS100

Powder fluidity measuring equipment



- **Instant and accurate result**
- **Easy and ready to use**
- **Reference equipment for powder development laboratories**

PERFORMANCE

- Accurate and quick measurement of the fluidity and of the ability of the powder to be fluidized
- Compact

PRODUCTIVITY

- Helps determine the powder spraying parameters
- Quality management of powder batches

SUSTAINABILITY

- Easy to clean
- Saves time for the commissioning of new powder paint facilities and/or new colors in the process

USE

The powder is placed in suspension in the porous-bottomed cylinder, by means of a controlled air flow. Successively the height of fluidised powder bed is measured, in the fluidised state (H1), then the height at rest (H0) and the weight (P) of the fluidised powder that flows 30 s through the calibrated opening. It is thus possible to define a "projectability" factor, a characteristic of the powder:

$$R = P \times (H1 / H0)$$

For information, for epoxy powders with a density between 1.3 and 1.6, experience shows that results in function of R are as follows:

R	Rating
> 140	Very good
120 to 140	Good
80 to 120	limited
< 80	Poor

The AS100 fluidimeter demonstrates this behaviour and indicates immediately whether a powder is suitable for spraying purposes. It is a valuable aid in product quality control for both powder paint manufacturers and other laboratories. This is the first electrostatic powder coating apparatus to be covered by a registered French standard (T 30 A doc 396).

TECHNICAL DATA

Description	Reference
Min. feed pressure (bar)	1
Maximum air flow (l/h)	500
Air inlet connector	fluted ø4 mm
Weight (kg)	5

Description	Reference
Fluidimeter AS100	451195

Warning:
the operator must collect a sample of paint so as to control it in a non hazardous location.

Operators accessories

1 COVERALL ANTI-STATIC

Size "S" to "XXL". Grey.
Extremely sturdy, recommended for liquid paint.
Contamination limited, reduced risk of electrostatic charge accumulation.



2 HAT, GREY (ONE SIZE)



3 COVERBOOTS (ONE SIZE)

4 DUST MASK

Meets European standard EN-149-2001, class FFP2. Provides protection only from wearer from mechanically and hermally produced particulates. May be used to protect against concentrations up to 10 times the Average Exposure Value (AEV), Belgium upper limit (VLB).



5 ANTI-SOLVENT MASK

Complies with European standard EN 405:2001. Protection against most vapours/gases and particles such as:

- Inorganic vapours and acid gas, up to 1000 ppm or 10 x VME/VLB, taking the lowest of the 2.
- Particles up to 50 x VME/VLB



Operators accessories

6 GLOVES - NITRILE RUBBER (ONE SIZE)

Provide protection against numerous chemicals such as alcohols, aromatic and chlorinated solvents (within the provisions of the chemical resistance chart).
Complies with European 89/686/CEE Directive.



7 LIGHT PROTECTION COVERALL (ONE SIZE)

Woven paper overall very sturdy. The use of overalls is recommended to protect against micro-particles, splashing and spray dust, depending on the degree of toxicity of the products and working conditions .
Complies with European EN 13982/1 and EN 13034 standards.
Certified types 5 and 6.

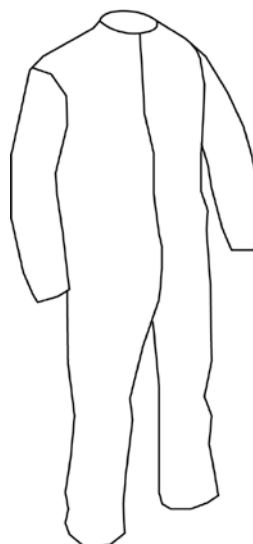

N°	Reference
1	(S) W5GMAS059
	(M) W5GMAS060
	(L) W5GMAS061
	(XL) W5GMAS062
	(XXL) W5GMAS063
2	W5GMAS070
3	W5GMAS071# (x10 qt)
4	W5GMAS018 (x10 qt)
5	W5GMAS035
6	W5GGAM039
7	W5GMAS024

N°1: Anti-static work-suit, size S, M, L, XL, XXL

Index

A		H	
Anti-solvent mask	66	Hat	66
AS100	65	high voltage	64
Assistance and technical support	6	HVP500	64
ATEX zones	59	I	
Automatic applicator	26	Inobell	30
B		Inobell R	36
Booth	52,	Inoboath	51,
	54		60
Booth range	51	Inobox	15,
			18
C		Inocart equipment range	18
Central	56	Inocart H	22
Control system	38	Inocart HF	24
Counter electrode	35	Inocart NDT	24
Coverall anti-static	66	Inocart VT	20
Coverboots	66	Inocenter	58
CS 130	21,	Inocoat range	50
	23	Inocontroller	27,
CS130	44		29,
Cyclone	55		35
D		Inogun A	28
Dust mask	66	Inogun A FCC	28
E		Inogun M	14
Engineering	9	Inogun R	34
Engineering solutions	50	Inomaster	42
F		Inomotion	39,
Filter	57		42
G		Inoprofile	40
Global presence	10,	Inorecip	38
	11	Inosieve	48
Gloves	67	Inotank	48
		Inotransfer	46

Index

L

Light protection coverall 67

M

Measuring device high voltage 64

P

Painting test center 10

PLC 43

Plunger tube 44

Powder coating system 51

Powder feed center 58

Powder feed systems 48

Powder systems 50

PVV EasyColor 51,

62

PVV EasyCompact 51,

61

Q

Quality assurance 7

Quick color change 52

R

Range of powder equipment 12

Reciprocator 38

Repair 6

Research & Development 8

Robotic applicator 34,

37

Rotating bell applicator 36

Rotating bell applicator 30

S

Sieve 55

Spare parts 6

T

Table of contents 3

TCR 31

TCR 5 37

TEC 5 16,

28,

34

Tools & Accessories 64

Training 6

U

UHT165 37

V

Vibrating table 48

W

When using Corona or Bell ? 12

Bond | Protect | Beautify

With our manual guns, automatic and robotic applicators, supplied by our wide range of pumps & machines for fluid handling, dosing, mixing & dispensing.

SAMES KREMLIN provides industrial solutions for production increase, quality improvement, material & cost savings.

We are designers and manufacturers of process equipment that is divided into **6 ranges**:

Airspray: Since 1925, we have been an Airspray manufacturer bringing you the very best in finishing.

Airmix®: Creator of Airmix® Technology since 1975, we provide the perfect mix between quality and productivity.

Airless®: We provide premium Airless Products for finishers with demanding applications.

High Viscosity: Pumping beyond possible, dispensing precisely.

Electrostatic: expertise for high finishing quality & efficiency.

Powder: Powder coating solutions for the highest Productivity since 1960.

FIND YOUR
LOCAL CONTACT
BY FLASHCODE:

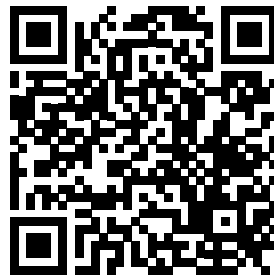

www.sames-kremlin.com



13 chemin de Malacher - CS 70086
38243 MEYLAN Cedex - FRANCE
Phone: +33 (0)4 76 41 60 60 - Fax: +33 (0)4 76 41 60 90