

# SAMES KREMLIN

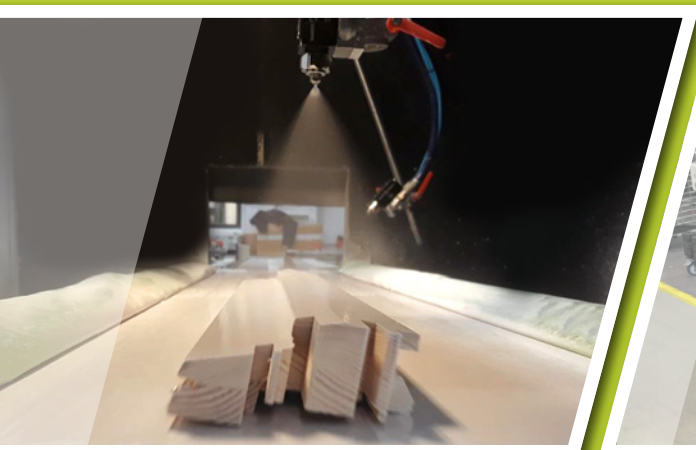

## AIRLESS® spraying & equipment



## Catalog **v5.2**

"We provide premium Airless Products for finishers with demanding applications"

## Apply your Skills

**SAMES KREMLIN** reserves the right to modify the equipment introduced in this catalogue as well as their specifications without notice.  
Any representation or reproduction, even partial, carried out by any means whatsoever, and without **SAMES KREMLIN**' prior knowledge and agreement, is illegal, and constitutes counterfeiting and infringement as sanctioned by the articles L.335-2 and following of the Intellectual Property code.  
Document, products and pictures shown are not contractual - Graphic designer: Cyril Brouillet - Contact: [marketing@sames-kremlin.com](mailto:marketing@sames-kremlin.com)  
Printed in France - July 2021 - Ref: **573 727 002**



SAMES KREMLIN - **Headquarter** - 13 chemin de Malacher - 38243 **MEYLAN**  
≈ 236 Employees / 15 000 m<sup>2</sup>



SAMES KREMLIN - 150, avenue de Stalingrad - 93240 **STAINS**  
≈ 220 Employees / 20 000 m<sup>2</sup>

## Editor's **note**



To help you increase your competitiveness, **SAMES KREMLIN** dedicates itself daily to excellence in terms of innovation and reliability.

We are constantly improving our performances as well as quality to meet your specific needs.

We also help you define the equipment allowing your installation to comply with V.O.C. directives and industry standards.

We enable you to benefit from reliable technologies while ensuring you a swift return on investment.

In this catalog, you will find the equipment that will enable you to reach the paint application results you are targeting and the finish quality you desire.

**Our mission is to provide you with the best equipment to meet your needs and requirements.**

The entire team at **SAMES KREMLIN** is at your disposal to answer your questions.

Enjoy your reading.

# Table of contents

## PRODUCTS RANGE

<b>MANUAL SPRAY GUNS</b>	<b>12</b>	<b>FLUID REGULATORS</b>	<b>62</b>
SFLOW™ 275 & 470	13	Pressure regulator manual & piloted control	63
<b>AUTOMATIC SPRAY GUNS</b>	<b>16</b>	REGSMART Regulators	64
ASB	17	REGSMARTER Regulators	65
ASC	19	<b>HEATER</b>	<b>66</b>
Automatic Spray Gun 400 bar	20	Magma 500	66
<b>TIPS AND SPRAYING ACCESSORIES</b>	<b>21</b>	<b>FLUID LINE</b>	<b>68</b>
AIRLESS® spray tips	22	CTM Color Change Valves	68
Tip guard	25	Filters	69
AIRLESS® Extensions	26	Suction and flushing rod	70
Accessories for AIRLESS® guns	27	Cyclix™ agitators	72
<b>MAINTENANCE KIT FOR OLD AUTOMATIC GUNS</b>	<b>29</b>	Fluid Hoses	73
<b>CUP PUMPS</b>	<b>30</b>	Fittings	75
Selection table of Cup pumps	32	<b>AIR LINE</b>	<b>79</b>
10C18	34	Air Hoses	79
15C25	35	Fittings	80
15C50	36	<b>PRESSURE REGULATORS</b>	<b>82</b>
30C25	37	Air regulators	82
35C50	38	DE37 Purifier-regulator	82
40C50	39	<b>PROTECTION</b>	<b>83</b>
40C50 WB	40	RC 756 respirators	83
40C100	41	Protective overalls	84
40C100 WB	42	Protective hood	84
40C260	43	Lubricants & greases	85
Azur™ 52C225	44	<b>ACCESSORIES</b>	<b>86</b>
65C260	45	Compatibility of trolleys	86
Azur™ 72C160	46	<b>GENERAL INFORMATIONS</b>	<b>88</b>
80C220	47	Paint	88
<b>FLOWMAX® PUMPS</b>	<b>48</b>	Surfaces preparation	89
Selection table of Flowmax® pumps	49	Components of paint	90
34F60	50	Paint consistency	91
40F50	51	Drying of paints	93
40F100	52	<b>PRACTICAL PAGES</b>	<b>94</b>
40F260	53	<b>PRACTICAL INFORMATION</b>	<b>98</b>
65F260	54		
<b>MECHATRONIC &amp; ELECTRONIC DOSING</b>	<b>56</b>		
PU 3000 AIRLESS®	57		
CYCLOMIX™ Micro	58		
CYCLOMIX™ Multi	59		
CYCLOMIX™ II & Expert	60		

Flash this QRcode to request a private access to download every user manual.



# Customer satisfaction

## SAMES KREMLIN HAS WORKED OUT A COMPLETE OFFER OF SERVICES, ADAPTED TO ALL YOUR NEEDS:

Advice, repair, servicing, adjustment or intervention by a qualified technician. Whatever your request may be, **SAMES KREMLIN** Customer satisfaction department, is at your disposal to answer your needs within the shortest time.



### > HOTLINE



**SAMES KREMLIN** has a quality hotline which takes care of our customer satisfaction. Please fill free to contact us. Our customer service team would like to provide an answer under 48 hours.

**+33 (0)1 49 40 25 28**

Monday to Friday: 8:30 - 12:00 am & 13:00 - 17:30 pm

### > AUDIT



In order to make the most from your installation, paint or powder, advice and expertise of specialists are essential. Made of practical, experienced members, **SAMES KREMLIN** customer support team will carry out a diagnostic of your installation and will provide you with a worthy technical assistance for the improvement or retrofit of your paint line.

### > REPAIR



A regular, and carried out professionally, maintenance or a retrofit of your equipment, is the best way to guaranty the correct running of your equipment. To this end, do not hesitate to contact one of our technicians:

- to get technical advice or technical assistance by phone
- to get one of your product repaired or controlled
- to carry out a retrofit

### > SPARE PARTS



Original spare parts guaranty the correct running of your equipment. We are here to deal with all your orders of spare parts throughout the world. Thus, our aim is to rapidly supply you and at the best price, with the wished part in order to guaranty an optimum and prolonged running of your paint or powder application equipment.

### > TRAINING



**SAMES KREMLIN** is registered as a training centre by the French Ministry of Employment. Training sessions that allow you learning the requisite knowledge to the use and the maintenance of your equipment are organised throughout the year. A catalogue can be obtained upon request. You will be then able to choose among the proposed selection of training courses, the type of training that meets your needs or production aims. These training sessions can be organised within your premises or in our training centre located in our headquarters in Meylan - FRANCE.



# Quality insurance

In conformity with the ISO9001 standard - issue 2008, the requisite procedures and registrations are mastered. The seriousness with which **SAMES KREMLIN**'s quality policy is dealt ensures you an optimum quality at each stage of the production and of the assembly of the components.

Our products are in the scope of the following European directives:

- 2014/34/UE Explosive Atmospheres
- 2006/42/CE Machinery
- 2014/35/UE Low Voltage
- 2014/30/UE Electromagnetic Compatibility
- 2011/65/UE RoHS Restriction of Hazardous Substances in electrical and electronic equipment
- 2012/19/UE WEEE Waste of Electrical and Electronic Equipment
- 1907/2006/CE REACH Registration, Evaluation, Authorization and Restriction of Chemicals.

A process mapping allows organizing all the stages while being very attentive to the various environments (customers, competition...), to the audits (inner and outer) and to the indicators linked to the defined aims.

## PROCESSES MAPPING

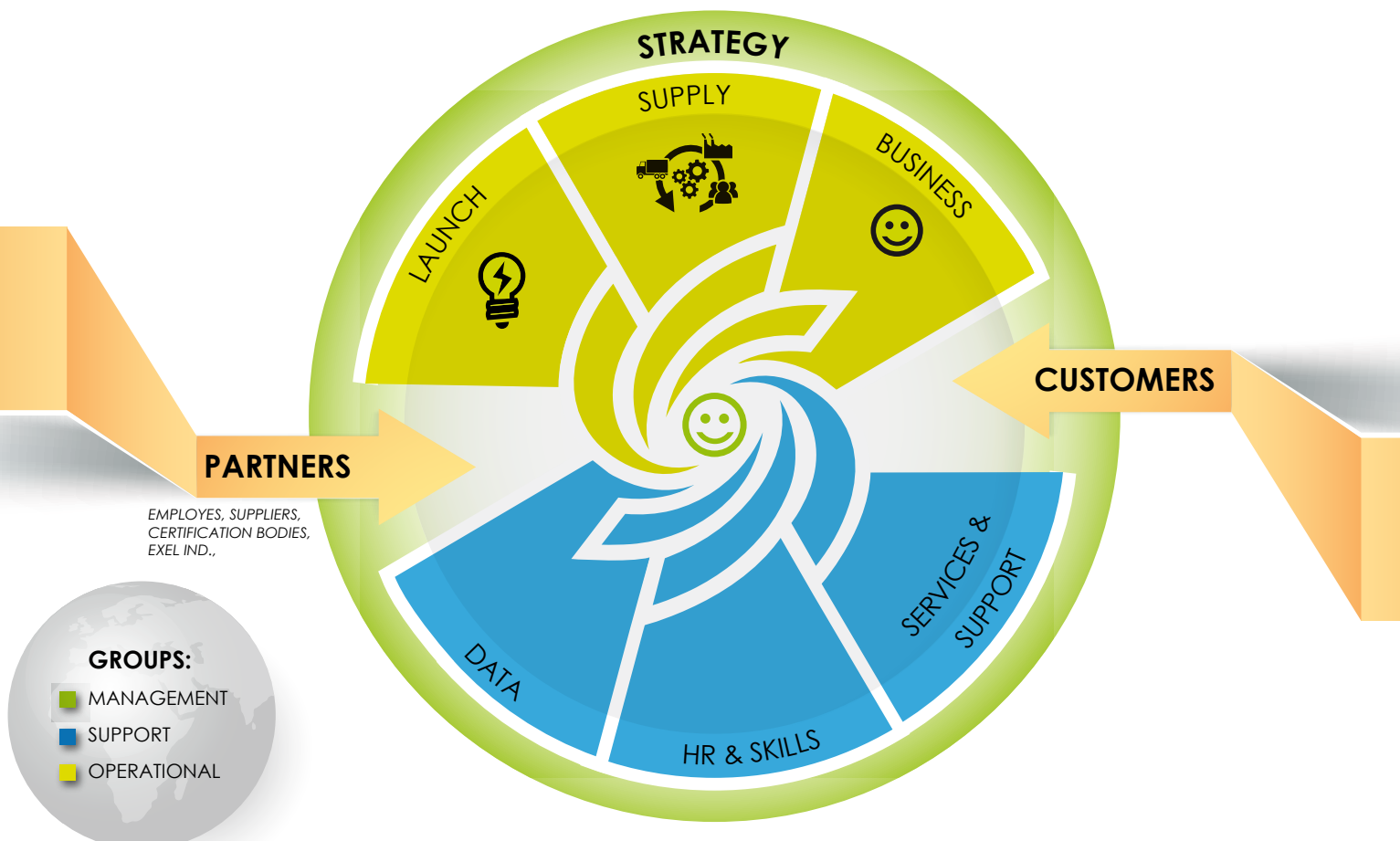

# Global presence

16 Locations

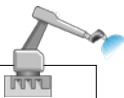

**USA**

**SAMES KREMLIN**  
Application Lab

45001 5 Mile Rd,  
PLYMOUTH, MI, 48170  
Ph: +1 734 979 0100

**CANADA**

**SAMES KREMLIN**

931, Progress Ave, Unit 7  
SCARBOROUGH M1G 3V5  
Ph: +1 800 450 0655

**MEXICO**

**SAMES KREMLIN**

BERNARDO GARZA TREVINO # 1715  
COL DE MAESTRO MONTERREY, N.L  
CP 64180 MEXICO  
Ph: +52 (442) 161 2595

**BRAZIL**

**SAMES KREMLIN**

Rua Alfredo Mario Pizotti, N.41  
Vila Guilherme  
SAO PAULO SP  
Ph: +55 (11) 2903 1200

**ARGENTINA**

**SAMES KREMLIN**

Avenida Juan Justo, 6021  
C1416DLB CIUDAD DE BUENOS AIRES  
Ph: +54 11 45 82 89 80

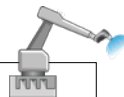

**FRANCE**

**SAMES KREMLIN**  
Headquarter

Application Lab

13 chemin de Malacher  
38243 MEYLAN Cedex - France  
Ph: +33 (0)4 76 41 60 60

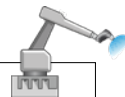

**FRANCE**

**SAMES KREMLIN**

Application Lab

150, av. de Stalingrad  
93245 STAINS Cedex - France  
Ph: +33 (0)1 49 40 25 25

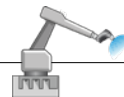

**GERMANY**

**SAMES KREMLIN GmbH**  
**INTEC SAMES KREMLIN GmbH**

High viscosity application Lab

Otto - Hahn - Allee 9  
50374 Erftstadt - Germany  
Ph: +49 (0)2235 46558 - 0 (INTEC)  
Ph: +49 (0)2235 46558 - 220 (SAMES KREMLIN)

# Global presence

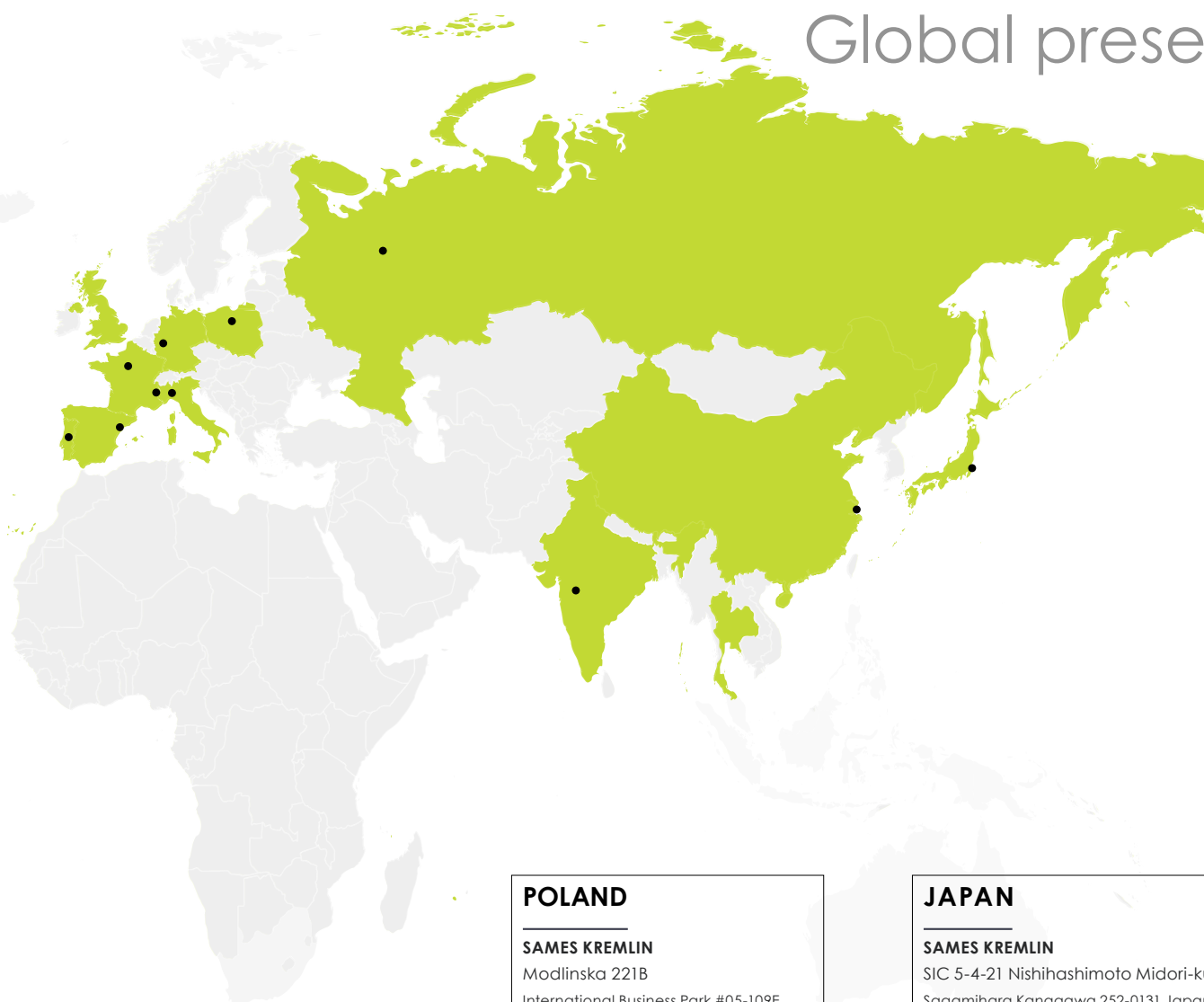

## POLAND

### SAMES KREMLIN

Modlinska 221B  
International Business Park #05-109E  
03120-WARSZAWA  
Ph: +48 225 10 38 50

## JAPAN

### SAMES KREMLIN

SIC 5-4-21 Nishihashimoto Midori-ku  
Sagamihara Kanagawa 252-0131 Japan  
Ph: 042 703 4430  
Mobile: +81 (0)45 412 5800

## PORTUGAL

### SAMES KREMLIN

Rua da Silveira, 554 - Touria  
2410-269 POUSOS LRA  
Ph: +351 244 848 220

## SPAIN

### SAMES KREMLIN

C/Botánica, 49  
08908 L'HOSPITALET DE LLOBREGAT  
BARCELONA  
Ph: +34 93 264 1540

## ITALIA

### SAMES KREMLIN

Linate Business Park  
Strada Provinciale Rivoltana 35  
20096 Pioltello (MI)  
Ph: +39 (0)2 48 95 28 15

## RUSSIA

### SAMES KREMLIN

Application Lab since the beginning of 2020

Rodionova str. 134.  
603093, N. Novgorod - Russia  
Ph: +7 831 467 8981



## INDIA

### SAMES KREMLIN

GAT no - 634, PUNE NAGAR Road, Wagholi  
PUNE - 412 207  
Ph: +91 (0)20 30472700/01

## CHINA

### SAMES KREMLIN

Application Lab

Building No.9, No.3802 Shengang Road  
Songjiang District  
SHANGHAI 201613  
Ph: +86 21 5438 6060

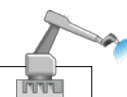

# AIRLESS® technology

## ➤ What is specific to AIRLESS® Liquid spraying technology?

The name «AIRLESS®» comes from the fact that the spraying is obtained without using compressed air. The product is pressurized by a pump and forced to flow through an extremely fine nozzle orifice called a tip.

The shape of the hole on the tip determines the spraying shape. If the hole is circular, the spray will be round. If the hole is elliptical, the spray will be flat. The flow rate of a tip depends on the hole diameter. There are 3 types of tips - FLAT, REVERSIBLE TIP TOP and SKILL™ for each painter job, depending on the business.



The AIRLESS® sprayer does not integrate any adjustment, resulting in very easy usage : therefore, to adjust the flowrate or the fan width, the proper tip should be selected depending on the atomizing pressure (our chart on **Page 22 to 24** will help you to select the best tip for your job).

## ➤ The equipment

Our AIRLESS® range is designed for manual or automatic spraying.

The minimum equipment needed for AIRLESS® spraying comprise a pump, one fluid hose and a spraygun.

- The pump **(1)** is equipped with a suction rod, suitable for any container **(4)**, or a gravity hopper **(4)**.
- The gun **(5)** is connected up to the pump with only 1 fluid hose **(6)**.

The operator will regulate the fluid pressure by manipulating the air regulator **(2)**. It is possible to plug a outlet filter **(3)** on the circuit to avoid tip lockage while spraying.

The choice of fluid hoses must be done according to the material viscosity, chemistry and the maximum pressure than the pump can deliver.

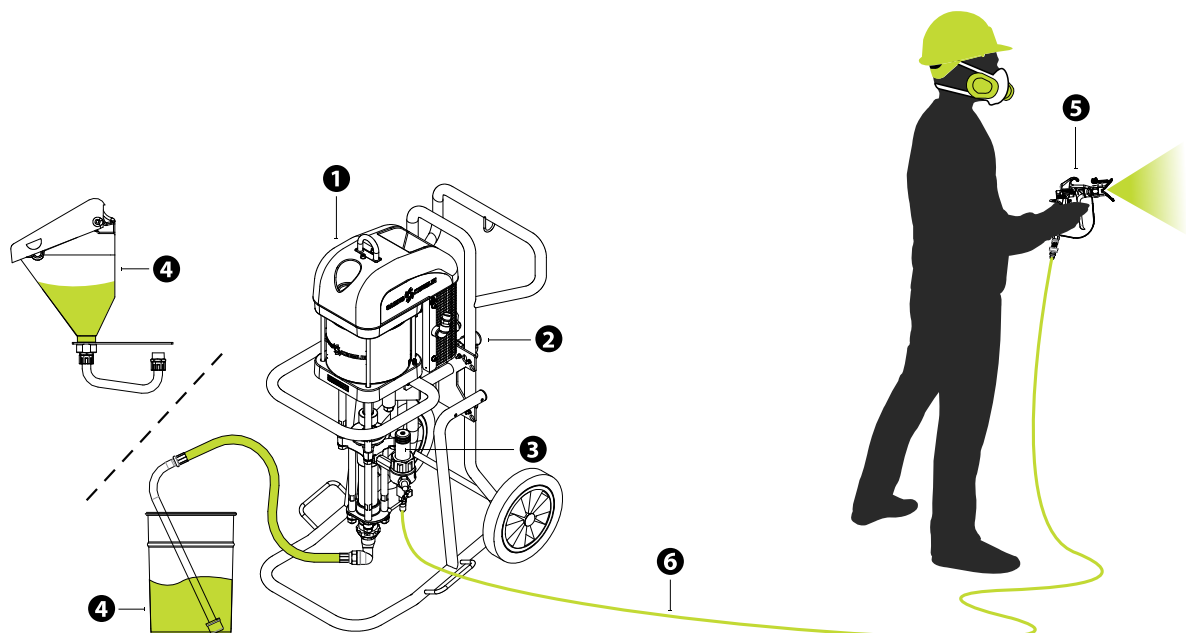



# AIRLESS® technology

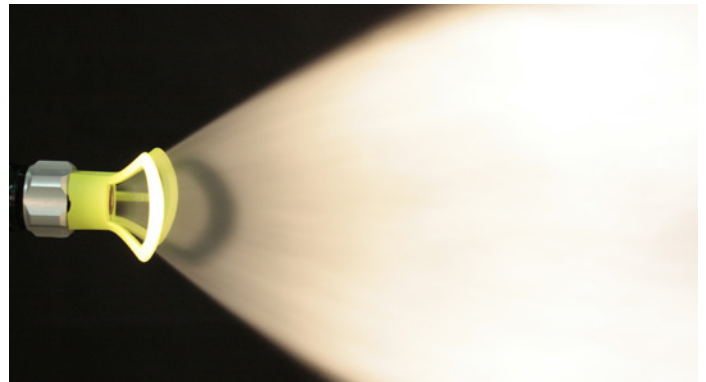

## > The performances

AIRLESS® sprayers are designed for big, relatively flat surfaces, such as walls, oil tanks and allows much higher productivity than any other existing spraying technology in the market (such as HVLP, conventional or AIRMIX® spraying) and the resulting layers are much more filling, but on the other hand the quality of the resulting droplets is most of the time lower and it is difficult to avoid orange peel.



## > AIRLESS® key points at SAMES KREMLIN

That's the reason why Sames Kremlin has decided to split the offer into 2 ranges: AIRLESS® Fine Finish and AIRLESS® Protective. On this catalog, every equipment will be tag with the relevant picto depending on the specific usage.

	 <b>AIRLESS® Fine Finish</b>	 <b>AIRLESS® Protective</b>
Benefits	<ul style="list-style-type: none"> <li>• Fast unblocking thanks to reversible tip system</li> <li>• Easy to set up : One tip will give one flowrate and one fan width</li> </ul>	
	<ul style="list-style-type: none"> <li>• Low overspray</li> <li>• High finish quality</li> <li>• No bubbling effect with UV paint</li> </ul>	<ul style="list-style-type: none"> <li>• Thick coats applied in one passage</li> <li>• High productivity</li> <li>• Material dilution required = reduction of VOC emission (decreasing the release of solvent into the environment)</li> </ul>
Optimal fluid pressure	Between 40B for Skill™ tip usage up to 240B	From 200B and above
Pump pressure ratio recommended	Below 40/1	Equal or above 40/1
Market recommendation	Wood coating Flatline on UV coating Metal finishing Agriculture Trailers Railway	Metal framework, GPL tank, Fire protection, Mega-yachting, Big shot blasting and painting workshop, Marine Oil & gas
Type of coatings chemistry recommended	Waterbased or solventbase Primer Polyester Acrylic Vinylic Cellulosic Single or Plural Component	
	UV Paint PU top coat Stains Epoxy primer	Up to 100% Solids Coatings Elastomeric Coatings (Silicone membranes) Epoxy or epoxy vinylic Coatings Epoxy Intumescent Fireproofing Materials High Solids Coatings ( typically 65% + Volume solids, VOC Compliant) Zinc rich organic and inorganic + glass flake charge material Antifouling – based with silicon or others Stripper Glue, Adhesives Sealant

# AIRLESS® technology

➤ The place of both AIRLESS® FineFinish and Protective coating inside the spraying technologies.

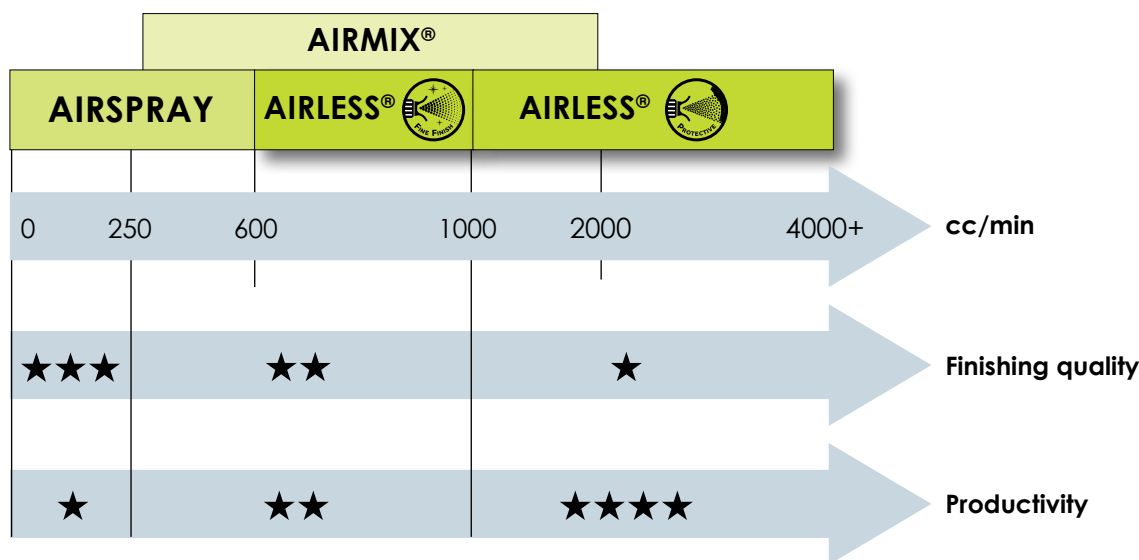

## ➤ Spraying principle

AIRLESS® spraying happens when the material under high pressure flows through a small hole called a tip. The shape of the hole determines the spraying pattern. If the hole is circular, the spray will be round. If the hole is elliptical, the spray will be flat.

Different tip sizes are available to achieve desired atomization and spray pattern size.

Our tips are built with 4 digit **XX-YY**:

- **XX** The size of the orifice, expressed by his diameter, determines the tip and associated flowrates of the application - the higher the value, the higher the flowrate

- **YY** give a theoretical fan width, spraying at 25 cm from the substrate - on our chart, we generally give an equivalent spray angle

There are 3 types of tips - Flat, reversible **Tip Top** and **Skill™** for each painter job, depending on the business.

No fan adjustments are possible with one tip.

### What are the benefits of AIRLESS® spraying

- The coating penetrates better into pits and crevices.
- A uniform thick coating is produced, reducing the number of coats required.
- A very «wet» coating is applied, ensuring good adhesion and flow-out
- Low dilution, high viscosity materials can be sprayed.

### The equipment

The AIRLESS® range is designed for manual, automatic and hot spraying. Our range of sprayer are able to work up to 470 bar (depending on models).

A standard AIRLESS® equipment consists of a pump, a hose and a gun.

- The pump must have an high pressure ratio, and is equipped with a suction rod, that is suitable for any container, or a gravity hopper for lower consumption. Ideally, the pump can held a filter on his output.

- The gun is connected up to the pump by a hose. in some cases, the hose can be splitted into 2 parts:

- one longer section with high internal diameter to avoid pressure losses,
- one whip end hose of 1 to 1.6m length with smaller internal diameter to insure operator maneuverability.

The choice of fluid hoses must been done according to the material sprayed and the maximum pressure than the pump can deliver

### With AIRLESS® technology, you will be able to apply many kind of material:

- Waterbased
- Solvent based
- Epoxy primer,
- High rich zinc primer
- PU Top coat
- Acrylic
- Vinylic
- Antifouling
- Stripper
- Polyester
- 2K material with or without acid or moisture sensitive catalyst
- High Solid Content
- Glue, Adhesives
- Sealants

# Spray Pack

In this chapter, you will find our AIRLESS® solution that includes:

**A PUMP** equipped with 1 manometer :

- to control the pressure at the pump

**1 OR 2 FLUID HOSES::**

- 1<sup>st</sup> with high internal diameter available in 7.5, 10 or 14m length
- 2<sup>nd</sup>, whip end hose with smaller internal diameter with 1.6m length

**ONE MANUAL SPRAY GUN**

Some pack may offer additional accessories such as trolley, suction rod or gravity hopper, filters or spraying tip  
Please refer to the below table to select your spray pack.

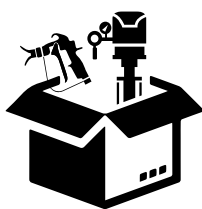

**= ON THE FOLLOWING PUMP PAGES, THIS PICTO MEANS THE PUMP IS ALSO AVAILABLE ON SPRAYPACK VERSION**



Pump type	Maximum output pressure bar (psi)	Set-up	Sealing	Filter	Suction rod	Hoses length m (ft)	Gun type (Fingers)	Swivel fitting	Tip guard	Tip	P/N	Specific usage
10C18	60 (870)	Wall Mounted		-	Without F 1/2" BSP	-					151.665.800	
30C25	180 (2610)	Wall Mounted	GT	-	Without M26x125	1.6 + 7.5 (5+25)	SFlow™ 275 (2F)	-	For Flat tip	-	151.265.001	AIRLESS® Fine Finish
				✓	✓			✓	151.265.002			
		Cart		-	✓			6L Hopper	✓	151.265.004		
		Wall Mounted	MBA	-	Without M26x125			-	151.265.011			
				✓	✓			✓	151.265.012			
		Cart		-	✓			6L Hopper	-	151.265.013		
35C50	210 (3 045)	Wall Mounted		✓	✓	✓			Tip Top 12-13 (515)	151.148.550		
40C50	240 (3480)	Cart	PTFE G + Polyfluid	Prime kit	✓	✓	SFlow™ 275 (4F)	✓	For reversible tip	Tip Top 14-13 (517)	151.265.102	AIRLESS® Protective
Wall Mounted		✓		151.265.103								
Cart		Prime kit		151.265.202								
Wall Mounted		✓		151.265.203								
40C100WB		Cart		Prime kit							✓	
Azur™ 52C225	312 (4 525)	Cart	PTFE / UHMWPE	-	✓	15+1.6	SFlow™ 470 (4F)			151.265.302	3522253171525	AIRLESS® Protective
		Cart		✓	1" 1/4			151.265.303	3522253111525			
		Cart		✓	20L Hopper			3522253431525				
Azur™ 72C160	432 (6 265)	Cart	-	✓	1" 1/4					3721603171525	3721603111525	
		Cart	✓	1" 1/4						3721603111525		
		Cart	✓	20L Hopper						3721603411525		



# Manual spray guns

The SFlow™ gun family allows real material savings for industrial applications. The SFlow™ gun brings an excellent comfort to the operator with fatigue free trigger and comfortable grip.

SFlow™ family uses high quality components which ensure a perfect reliability maintaining a high level of performances. Our range of tips delivers high transfer efficiency up to 81% optimizing efficiency

Features	Benefits
High end tungsten carbide tip tested individually	Reliable and repeatable spraying quality
Trigger lock, tip lock, and hand safety protection	Enhanced security
Embedded patented dedicated tool	Quick filter change
Ergonomic design	Comfortable grip to prevent any mdSs
Build-in hook	To keep the gun near the workstation
Swivel handle fitting	Insure better maneuverability
Fatigue free 2 or 4 fingers	To fit every painter morphology
Smart lock	Quick & easy tip orientation and positioning
Large filtration area	Available in PA or stainless steel to prevent any tip plugging

## SPECIFICATIONS DETAIL FOR EACH GUN

		SFlow™ 275	SFlow™ 470
Body of the gun		Forged aluminum	
Maximum fluid pressure (bar (psi))		275 (4 000)	470 (6 817)
Fluid output		Depends on the tip used	
Weight	With Swivel / g (lbs)	597 (21)	
Maximum fluid Temperature (°C (°F))		60 (140)	
Wetted parts		Stainless steel, PTFE, carbide	
Safety		Trigger lock	
Filter (fitted on fluid tube)		#6 - 85 MESH / 168µ	
Seat		Carbide	
Fittings	Fluid inlet without swivel fitting	M 1/2 JIC	
	Fluid inlet with swivel fitting	M 1/2 JIC or M 1/4 NPSM (depending on models)	
Sprayed material	Waterbased	✓	
	Solvent base	✓	✓
	Primers	✓	✓
	Stains	✓	✓
	Direct Gloss / Metallic	-	-
	Top coats / High Gloss	-	-
	UV products	✓	✓
	Moisture sensitive	✓	✓
	Two components	✓	✓
	Anti-corrosion / abrasives	✓	✓
	Adhesives	✓	✓
	Sealants	✓	✓
	Greases	✓	✓
Wax	✓	✓	

# SFLOW™ 275 & 470

The SFlow™ is an AIRLESS® paint sprayer used for applying protective coatings and is available in 275 and 470 bar (4000 & 6820 psi) pressures. This gun delivers real product savings for industrial applications. The ergonomic design offers flexibility in extreme conditions and is ideal for handling high solid content paints and high rich zinc primers.



- High transfer efficiency of 81%
- Good atomization quality
- Designed for high duty industrial applications

NO NEED TO BE ROUGH TO BE STRONG



## CONFIGURATION OF SFLOW™ SPRAY GUN

Tip guard type	Tips	Maximum Fluid pressure (bar)	Trigger	Swivel fitting	Handle fluid fitting	Included hose	Part number		
For flat tip	- (1)	275	2 fingers	-	1/2" JIC		135.740.200		
			4 fingers				135.740.400		
			2 fingers				135.740.240		
		470	4 fingers		1/4" NPSM		135.740.440		
			2 fingers		1/2" JIC		135.745.420		
					1/4" NPSM		135.745.440		
For reversible Tip Top tip(2)	TIP TOP 12-13 (515)	275	2 fingers	✓	1/2" JIC		135.740.220		
			4 fingers		1/2" JIC		135.740.420		
			2 fingers		1/4" NPSM		135.740.225		
	TIP TOP 14-13 (517)	275	2 fingers		1/4" NPSM		135.740.245		
			4 fingers		1/2" JIC		135.740.425		
					1/4" NPSM		135.740.445		
	TIP TOP 18-13 (519)	470	4 fingers		1/2" JIC		1/2" JIC	135.740.427	
					1/4" NPSM		1/4" NPSM	135.740.447	
					1/2" JIC		1/2" JIC	135.745.429	
	TIP TOP 14-13 (517)	275	4 fingers		4 fingers		1/4" NPSM	✓ 15 m Ø3/8" + 1,6m Ø1/4"	151.590.016
							1/2" JIC	✓ 5 m Ø1/4"	151.245.400
							1/2" JIC	✓ 10 m Ø1/4"	151.245.500

(1) : to be order on page 23 - 24  
 (2) : full list of Tip Top reversible tip on page 22

## Maintenance kits

Description	Part number
Maintenance kit for SFlow™ 275 (needle and spring)	129.740.901
Maintenance kit for SFlow™ 470 (needle and spring)	129.740.902
Seal kit - o'ring (x10)	150.040.341
Seal kit - cartridge (x10)	109.420.298

# SFLOW™ 275 & 470

## Accessories

Description	Part number
2 fingers trigger	129.740.006
4 fingers trigger	129.740.007
F 1/2 JIC - M 1/4 NPSM fitting	050.123.304
THREAD ADAPTOR SFLOW FOR TIP GUARD 7/8"	129.740.030
THREAD ADAPTOR SFLOW FOR TIP GUARD 11/16"	129.740.032
PACK OF 5 S/STEEL SCREEN NO 4 FOR DEFLECTOR	129.982.021
PACK OF 5 S/STEEL SCREEN NO 6 FOR DEFLECTOR	129.982.022
PACK OF 5 S/STEEL SCREEN NO 12 FOR DEFLECTOR	129.982.023
CS Nipple MM 1/2 JIC	050.102.301
SST Nipple MM 1/2 JIC	905.210.709
CS Nipple M1/2 JIC M3/4 JIC	905.160.201
SST Nipple M1/2 JIC M3/4 JIC	906.314.217
SST Nipple MM 1/4 NPSM 500B	150.104.151
SST Nipple MM 3/8 NPSM 500B	150.104.152
SST Nipple M1/4 NPSM M3/8 NPSM 500B	905.210.516
Pack of 10 Diffusers	129.740.910

## Filters

Number of screens	Screen size	Materials	Color	Recommended tips	Part number
Pack of 4	200 mesh (74µm) handle filter	Stainless steel	Red	04-xx to 06-xx	129.740.081
		PA			129.740.181
	150 mesh (100µm) handle filter	Stainless steel	Blue	06-xx to 12-xx	129.740.082
		PA			129.740.182
	100 mesh (150µm) handle filter	Stainless steel	Yellow	12-xx to 18-xx	129.740.083
		PA			129.740.183
	50 mesh (300µm) handle filter	Stainless steel	White	18-xx to 100-xx	129.740.084
		PA			129.740.184

## Recommended hoses with JIC fittings

Description	Fluid hose diameter (mm)	Max fluid pressure (bar)	Fittings	Hose length (m)	Part number	
Whip end hose	3,2	240	F 1/2 JIC	1,6	050.451.155	
	4,8				050.450.654	
	6,35				050.450.155	
Fluid hose	4,8	240		F 1/2 JIC	7,5	050.450.951
	6,35					050.450.605
	9,52	425		F 3/4 JIC	10	050.450.111
			14			76.085
						76.842

## Recommended hoses with NPSM fittings

Description	Fluid hose diameter (mm)	Max fluid pressure (bar)	Fittings	Hose length (m)	Part number
Whip end hose	6.35 (1/4)	350	F 1/4 NPSM	1,6	050.350.103
		500			050.500.103
		350			050.350.107
Fluid hose	6.35 (1/4)	500	F 1/4 NPSM	15	050.500.107
		350			050.350.207
	9.52 (3/8)	350	F 3/8 NPSM	15	050.350.207
		500			050.500.207



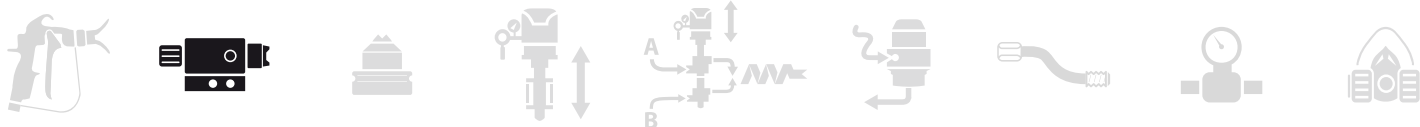

# Automatic spray guns

Our automatic gun range family is the result of **SAMES KREMLIN** experience since 1925.



Our compact design and reduced weight increase the performances and the efficiency of the automatic machines.

This range is delivering unsurpassed quality of atomization, providing high finish quality and important product savings. Worldwide recognized by professionals, our automatic range is widely used in automatic finishing lines in most markets.

For guns assembled on base, the fluid circulation is available in the base (no pressure loss) or inside the gun (quick flushing).

Features	Benefits	Specific to one family
Equipped with 2 fluid inlets	Perfect for fluid circulation and saves money by eliminating the need for a 2-way valve on color or flushing	ASB
No spring in the fluid passages	Saves time and money by making it easier to clean, faster color changes and less maintenance	All
fitted with a GT cartridge	Strong resistance to very abrasive UV and HS materials for an improved reliability	ASB
Small ball needle	For an improved laminar fluid passage	ASB
Modular design	Quick service: only 4 bolts to unscrew, no need to remove hoses	ASB
Compact Design	Minimal payload on the machine for efficient production.	ASC
Large dimension fluid passages	Minimized the pressure drop and allows to work from liquid to semi-viscous materials	AIRLESS
Choice of circulation in the base or the gun	Performance level guaranteed for most materials and easy flushing	ASB
Choice of bases with rear or side connections	To fit each customer need and line configuration	ASB
Wide range of AIRLESS® tips	Provides many patterns choices to fit each customer need	All
Lightweight design	Possibility to mount more guns on a reciprocator without exceeding the weight limit	ASB
Integrated filtration	Allows longer works without tip clogging	ASB & ASC
Double effect gun	High cycling rate (opening / closing)	ASC & AIRLESS

## SPECIFICATIONS

		ASB 	ASC 	AIRLESS gun 
Body of the gun		Forged aluminum	Stainless steel	Forged aluminum
Fluid pressure range (bar (psi))		Up to 240 (3480)	Up to 240 (3480) Up to 400 (5800)	Up to 400 (5800)
Maximum air inlet pressure (bar (psi))		6 (87)		
Minimal trigger air pressure (bar (psi))		4		
Fluid output		Depends on the tip used		
Weight - gun only (g (lbs))		336 (0.74)	397 (0.88)	585 (1.29)
Maximum fluid Temperature (°C (°F))		50 (122)		
Wetted parts		Stainless steel - treated stainless steel		Stainless steel and steel
Sealing		PTFE or GT		PTFE
Seat		Carbide		
Fittings	Fluid	On the base	F 1/4 NPS	
		Delivered but not fitted	M 1/4 NPT - M 1/2 JIC	-
		On the gun	-	M 1/2" JIC
	Pilot air	on the base	F 1/8 NPS	-
Delivered but not fitted		M 1/8 BSP - quick fitting ø4x6	-	-
On the gun		-	Elbow - 2.7 x 4 hose	Elbow - 2.7 x 4 hose
Head thread		M25x175		M 11/16"
Sprayed material	Waterbased	✓	✓	✓
	Solvent base	✓	✓	✓
	Primers	✓	✓	✓
	Stains	-	-	-
	Direct Gloss / Metallic	-	-	-
	Top coats / High Gloss	✓	✓	✓
	UV products	✓	✓	-
	Moisture sensitive	✓	✓	✓
	Two components	✓	✓	✓
	Sealants	-	✓	✓
Greases	✓	✓	✓	



# ASB

The ASB automatic spray gun offers superior atomization whatever the line speed thanks to perfect balance between high pressure and high flow rate. It offers precise application - coating applied directly on the target - due to fast response time.

- Premium AIRLESS® application
- The lightest automatic AIRLESS® gun of the market
- Low maintenance cost of ownership



## ACCURACY AT HIGH SPEED AIRLESS® APPLICATION



## Configuration of ASB spray gun

Description	GT cartridge	PTFE cartridge	Base & Tip	Tip guard	Part number
ASB 240 GT Flat tip guard w/o base	✓	-	To be ordered separately	For flat tips	129.990.300
ASB 240 GT Reversible tip guard w/o base				For reversible tips	129.990.500
ASB 240 PTFE Flat tip guard w/o base	-	✓		For flat tips	129.990.200
ASB 240 PTFE Reversible tip guard w/o base				For reversible tips	129.990.400

## Maintenance

Description	Part number
Package of seals	129.990.060
GT cartridge - Carbide needle assembly	129.990.040
PTFE cartridge - Carbide needle assembly	129.990.050
Carbide seat holder assembly	129.740.040

## Compatible base for ASB gun (without gun)

Description	Base type	Detail	Weight (g)	Filter	Wetted parts	Part number
Base for ASB (circulation in the base (⊥))	side outlet	Standard flat	240	-	Stainless Steel	129.690.070
CEFLA base for ASB (circulation in the base (⊥))	-	For Cefla machine	-		129.690.090	
Base for ASB (circulation in the gun (Ω))	-	Standard flat	-		129.691.070	
Base for ASB (circulation in the base (⊥))	rear outlet	Standard flat	480		129.690.080	
Base for ASB (circulation in the gun (Ω))	-	Standard flat	-	-	129.691.080	
Robotic Base for ASB (⊥) With filter	Behind	60°	540	✓	-	129.691.170
Robotic Base for ASB (Ω)	-	60°	540	-	-	129.691.160
Semi robotic Base for ASB (⊥) With filter	--	60°	540	✓	-	129.691.171
Semi robotic Base for ASB (Ω)	-	60°	540	-	-	129.691.161

## Accessories

Description	Part number
Pack of 2 fast fitting for cartridge lubrication	129.990.062
Filter support for robotic and semi-robotic base	129.691.180
N°4 Screen (x5) for deflector	129.982.021
N°6 Screen (x5) for deflector	129.982.022
N°12 Screen (x5) for deflector	129.982.023

**Fittings kit**

	Including				Part number
	MM 1/4" - 1/4 NPS	MM 1/4 NPT - 12/ JIC SST	Plug M 1/4 NPT SST	M 1/8" - Fast fitting 4x6	
Fitting kit for side outlet base	1	2 off Elbow	1	1	129.690.075
Fitting kit for rear outlet base	1	2 off Straight	1	1	129.690.085

**Support**

Description	Part number
Mounting support Ø 16	049.351.000
Mounting support Ø 12	049.351.700
Adjustable mounting support for Ø12 support	049.351.705

# ASC

The ASC automatic AIRLESS® gun is a concentration of technologies in a compact and lightweight body. High quality materials make the ASC a highly productive and durable gun. SAMES KREMLIN's finishing technologies deliver premium AIRLESS® applications.

- Premium AIRLESS® application
- Heavy duty sustainability
- High functionality



COMPACT BY BIRTH, PERFORM BY CHOICE



## Configuration of ASC spray gun

Description	Cartridge	Max Pressure (bar)	Tip	Tip guard	Part number
ASC 240 SST PTFE Flat tip guard	PTFE	240	To be ordered separately	Flat	129.982.121
ASC 240 SST PTFE Reversible tip guard				Reversible	129.982.122
ASC 240 SST GT Flat tip guard	GT	240		Flat	129.982.521
ASC 240 SST GT Reversible tip guard				Reversible	129.982.522
ASC 400 SST PTFE Flat tip guard	PTFE	400		Flat	129.984.121
ASC 400 SST PTFE Reversible tip guard				Reversible	129.984.122
ASC 400 SST GT Flat tip guard	GT	400		Flat	129.984.521
ASC 400 SST GT Reversible tip guard				Reversible	129.984.522

## Maintenance

Description	Part number
Package of seals	129.982.093
GT cartridge - Carbide needle assembly	129.990.040
PTFE cartridge - Carbide needle assembly	129.990.050
Carbide seat holder assembly	129.740.040

## Accessories

Description	Part number
Pack of 2 fast fitting for cartridge lubrication	129.990.062
N°4 Screen (x5) for deflector	129.982.021
N°6 Screen (x5) for deflector	129.982.022
N°12 Screen (x5) for deflector	129.982.023
Fast closing assistance	129.982.050
Manifold for fast color changes	129.982.060
1/2 JIC head	129.982.065

## Support

Description	Part number
Mounting support	129.982.030
Mounting rod Ø 16	049.351.000

# Automatic Spray Gun 400 bar



SAMES KREMLIN 400 bar automatic AIRLESS® spray gun is recommended for high flow rates. This gun has a remote fluid passage for easy maintenance.

- High flow rates
- 50 years of experience
- Reduced overspray



IDEAL FOR VISCOUS SPRAYING

## Configuration of 400 bar spray gun



Description	Sealing	Seat	Max working pressure (bar)	Tip	Part Number
AIRLESS Auto spray gun	PTFE V seals	Carbide	400	To be ordered separately	151.120.300

## Maintenance

Description	Part number
Seal kit (including packing)	101.331
Needle	203.014
Carbide seat	630.387
SST filter screen - 50 mesh (300 µ)	625.218
SST filter screen - 100 mesh (150 µ)	625.212
SST filter screen - 160 mesh (95 µ)	625.216
Pack of 4 filter seals	107.021

## Accessories

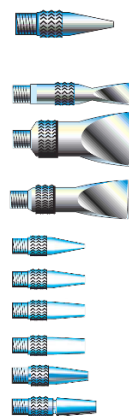
Description	Outlet fitting	Length mm (in)	Outlet orifice size mm (in)	Material	Part Number	
Color change adapter nozzle for manifold mounting	M 1/8" G co	-	-	-	203.948	
CS Cap to be mounted instead of the tip guard	F 1/4" G				630.649	
SST Cap to be mounted instead of the tip guard	F 1/4" G				203.033	
CS adaptor to be mounted instead of the tip guard	F10x100				630.647	
Extrusion nozzle 	M1/4" G	64 (2.52)	Ø1.6 (0.06)	Polyethylene	107.011.03	
		102 (4.02)	Ø0.8 (0.03)		107.011.01	
			Ø1.6 (0.06)		107.011.02	
Extrusion nozzles 	M10x100	43 (1.69)	Ø1.5 (0.06)	Chrome plated brass	670.135	
			Ø2.5 (0.1)		670.136	
			Ø3 (0.12)		670.152	
			Ø4 (0.16)		670.155	
			Ø1,5 x 8 (Ø 0.06 x 0.32)		670.134	
	43 (1.69)	-	Ø 2 x 30 (Ø 0.08 x 1.18)	Plastic	670.142	
			Ø 1,5 x 20 (Ø 0.06 x 0.80)		670.137	
			Ø1.5 (0.06)		670.128	
			Ø2.5 (0.1)		670.129	
			Ø4 (0.16)		670.130	
-	-	-	-	Carbon Steel	670.154	
					Ø2.5 (0.1)	670.157
					Ø4 (0.16)	670.156

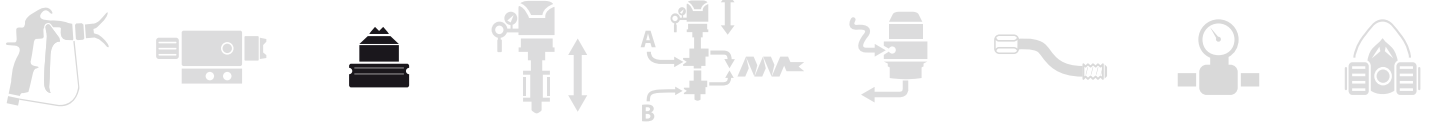

# Tips and spraying accessories

The choice of the tip must be done according to the desired flowrate and fan width in order to achieve a good paint coverage and reduce paint costs. An AIRLESS® tip needs to be replaced frequently in order to maintain the original transfer efficiency

## Why choosing our high quality tips?

To make sure that every tip built in our factory yields the best results, we follow a precise machining process that guarantees consistent material output at different spray angles each & every time. Our tips are built with carefully selected materials to guarantee a lifetime production.

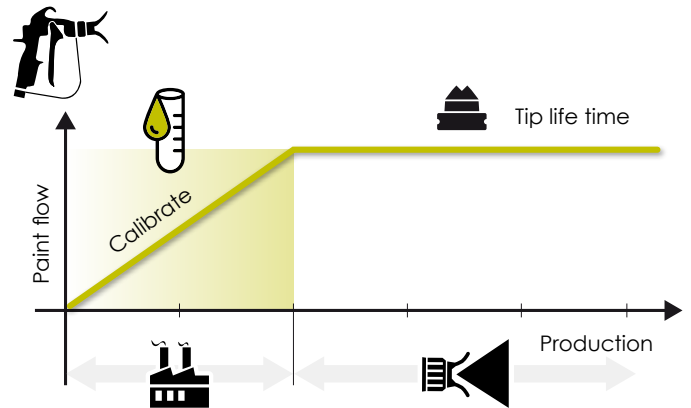



## How is build our offer

**Sames Kremlin** offers 3 types of AIRLESS® tips to fit to all customer requirement. These tips are fully compatible with our spray gun range.



Tip name	Tip Top	Flat	Skill™
Features			
Extremely quick unplugging without tools	✓	-	-
Premium finishing quality	-	-	✓
Standard on protective coating application	✓	✓	-
Compatible with most waterbased and solventbase applications	✓	✓	✓

## Ordering example

A customer needs to apply 1L/min at 140 bar of paint with a spray pattern of around 25 cm. Our tip chart gives us the following tip size:

1. First 2 XX digits : caliber #14 will deliver the appropriate flowrate at 140 bar
2. Last 2 XX digits : For a spray pattern width of 25 cm, we should choose a width caliber #13
3. The complete part number of the tip requested will be :
  - 000.401.413 for Tip Top reversible Tip
  - 000.001.413 for flat tip
  - 000.301.413 for Skill™ super finishing tip

Note : Tip Top tip size 100.XX will have part number 000.410.0XX

## > Tips and Tricks

At the end of the day, we recommend that you place your tip in a closed solvent bucket for easy cleaning.



# AIRLESS® spray tips

## Table of Tip Top reversible AIRLESS® spray - Tips 000.40X.XXX

Recommended for high working cadency.  
Time savings with extremely quick unplugging without tools.

Caliber	ø orifice (inch)	Water Output (L/min) at XXX bar			Handle Filter (MESH)	Pump filter Number (MESH)	Angle	Fan width (cm) at 25 cm							
		70	200	400				30°	40°	50°	60°	70°	80°	90°	
04	0,009	0,22	0,37	0,53	Red (200)	4 (140)			<b>04-09</b>	<b>04-11</b>	<b>04-13</b>				
									(309)	(409)	(509)				
06	0,011	0,33	0,56	0,79	Blue (150)	6 (85)		<b>06-07</b>	<b>06-09</b>	<b>06-11</b>	<b>06-13</b>	<b>06-15</b>			
								(211)	(311)	(411)	(511)	(611)			
09	0,013	0,45	0,76	1,08	Blue (150)	6 (85)		<b>09-07</b>	<b>09-09</b>	<b>09-11</b>	<b>09-13</b>	<b>09-15</b>	<b>09-17</b>		
								(213)	(313)	(413)	(513)	(613)	(713)		
12	0,015	0,6	1,01	1,43	Blue (150)	8 (70)		<b>12-07</b>	<b>12-09</b>	<b>12-11</b>	<b>12-13</b>	<b>12-15</b>	<b>12-17</b>		
								(215)	(315)	(415)	(515)	(615)	(715)		
14	0,017	0,72	1,22	1,72	Blue (150)	8 (70)		<b>14-07</b>	<b>14-09</b>	<b>14-11</b>	<b>14-13</b>	<b>14-15</b>	<b>14-17</b>	<b>14-19</b>	
								(217)	(317)	(417)	(517)	(617)	(717)	(817)	
18	0,019	0,95	1,61	2,27	Yellow (100)	12 (55)		<b>18-07</b>	<b>18-09</b>	<b>18-11</b>	<b>18-13</b>	<b>18-15</b>	<b>18-17</b>	<b>18-19</b>	
								(219)	(319)	(419)	(519)	(619)	(719)	(819)	
25	0,021	1,33	2,25	3,18	Yellow (100)	12 (55)				<b>25-11</b>	<b>25-13</b>	<b>25-15</b>	<b>25-17</b>	<b>25-19</b>	
										(421)	(521)	(621)	(721)	(821)	
30	0,023	1,6	2,70	3,82	Yellow (100)	15 (45)				<b>30-11</b>	<b>30-13</b>	<b>30-15</b>	<b>30-17</b>	<b>30-19</b>	
										(423)	(523)	(623)	(723)	(823)	
40	0,025	2,175	3,68	5,20	White (50)	15 (45)				<b>40-11</b>	<b>40-13</b>	<b>40-15</b>	<b>40-17</b>	<b>40-19</b>	
										(425)	(525)	(625)	(725)	(825)	
45	0,029	2,38	4,02	5,69	White (50)	20 (30)			<b>45-09</b>	<b>45-11</b>	<b>45-13</b>	<b>45-15</b>	<b>45-17</b>	<b>45-19</b>	
									(329)	(429)	(529)	(629)	(729)	(829)	
68	0,033	3,78	6,39	9,04	White (50)	30 (20)				<b>68-11</b>	<b>68-13</b>	<b>68-15</b>	<b>68-17</b>	<b>68-19</b>	
										(433)	(533)	(633)	(733)	(833)	
100	0,036	5,6	9,47	13,39	White (50)	30 (20)					<b>100-13</b>	<b>100-15</b>	<b>100-17</b>	<b>100-19</b>	
											(539)	(639)	(739)	(839)	

### Accessories

Description	Part number
Pack of 10 seals for reversible TIP ToP tips	134.740.007
Servicing kit (seat (x4) and seals (x4))	129.740.907



# AIRLESS® spray tips



## Table of Double Atomization Skill™ AIRLESS® spray Tips 000.30X.XXX

Double insert Skill™ tip allows low AIRLESS® atomizing pressure without tail. The new generation of Skill™ tips deliver a softer spray pattern on edges for a perfect overlapping on flat line and facilitates the settings on flat line machines.

**High reliability:** Always clean in production for high productivity with excellent atomization

**Easy maintenance:** This tip is easier to clean because of his dome shape design.

Tip Caliber	Diameter in mm	Diameter in inches	Water Output			Recommended Tip Diaphragm Auto gun ASI 24 & 40	Gun Filter (Mesh)	Pump Filter (Mesh)	Average Spray angle and fan width at gun target distance of 25 cm or 10 inches from substrate													
			Fluid Pressure - bar (psi)						03	05	07	09	11	13	15	17	19	21				
			70 (1000)	140 (2000)	200 (2860)				15°	25°	35°	40°	50°	55°	70°	80°	90°	100°				
			cc/mn	cc/mn	cc/mn				8 cm	10 cm	16 cm	21 cm	24 cm	29 cm	35 cm	40 cm	48 cm	60 cm				
			3.5 "	3.9 "	6.3 "	8.3 "	9.5 "	11.4 "	13.8 "	15.7 "	18.9 "	23.6 "										
04	0.23	0.009	220	310	370	12	Red (200)	4 (140)			04-07	04-09	04-11	04-13								
06	0.28	0.011	330	465	560		Blue (140)		6 (85)		06-05	06-07	06-09	06-11	06-13	06-15						
07	0.30	0.012	390	550	660	15		8 (70)			07-05	07-07	07-09	07-11	07-13	07-15						
09	0.33	0.013	450	635	760							09-07	09-09	09-11	09-13	09-15	09-17					
12	0.38	0.015	600	850	1015	15	Yellow (100)	12 (55)				12-09	12-11	12-13	12-15	12-17						
14	0.41	0.017	720	1020	1215									14-11	14-13	14-15	14-17	14-19				
18	0.46	0.019	950	1345	1605	20							18-13	18-15	18-17	18-19						
20	0.51	0.020	1060	1500	1790									20-13	20-15	20-17	20-19					

## Accessories

Description	Part number
Pack of 10 collars	134.980.002
Pack of 10 collars with integrated screen filter for low caliber #04 and #06	134.980.010



# Tip guard

The following chart represent our selection of tip guard compatible with our full range of guns and others.

Compatible with	SFlow™	✓	-	✓	-	Yes with adaptor 129.740.032				-	
	ASB	✓	-	✓	✓	Yes with adaptor 129.740.032				-	
	ASC	✓	-	✓	✓	Yes with adaptor 129.740.032				-	
	ASI range	Yes with optionnal diaphragm 129.740.074	-	✓	Yes with optionnal diaphragm 129.740.074		✓	✓	✓	✓	-
	AS2		-	-	✓	✓	✓	✓	✓	-	
	AIRLESS gun	-	-	✓	-	-	✓	✓	✓	-	✓
Thread	F25x175	F 7/8"	F 11/16"	F25x175		F 11/16"					
Tightening type	Manual					With wrench					
Tip guard	✓	✓	-	✓	-	✓	✓	✓	-	-	
Tip compatibility	Tip Top reversible	✓		-	-	-	-	-	-	-	
	Skill™	-		✓	✓	-	-	✓	✓	✓	
	Flat	-		✓	✓	-	-	✓	✓	✓	
	Part Number	132.740.200	132.740.210	132.740.220	132.740.100	129.740.071	922.562.000	922.552.000	922.004.202	000.152.290	630.390



Tip housing adaptor	Inlet thread	Outlet	Part Number
#1	F25x175	M 7/8"	129.740.030
#2		M 11/16"	129.740.032

# AIRLESS® Extensions

An extension is used to spray on part unreachable with the painter hand.

- 100% compatible with most of the solventborne and waterborne materials as the new extensions are in stainless steel.
- Only one working pressure up to 500B to avoid any risk
- Low weight with only
  - 77.9 g for the 300mm
  - 129 g for the 600mm
- Stainless steel extensions cannot be bent for longer lifetime and painter safety.



Length (mm)	Working pressure (Bar)	Material	Thread	Compatible with			
				Sflow™, ASB, ASC	AIRLESS automatic gun	Old AS2 and ASI range	Part Number
300	500	Stainless steel	25x175	✓	-	-	175740030
600				✓	-	-	175740060
300	250	Aluminum	11/16"	-	✓	✓	922030122
600				-	✓	✓	922030242
100				-	✓	✓	203426
150				-	✓	✓	625199
200				-	✓	✓	625174
				-	✓	✓	
Accessories							
Swivel head fitting	250	Aluminum	11/16"	-	✓	✓	922075062
Straight head				-	✓	✓	922024302



# Accessories for AIRLESS® guns

## Seat & seat assembly

Description	Quantity	SFlow™	ASB	ASC	AIRLESS	Old Guns			Part Number
						ASI 24 & 40	ASI40 GT & ASI 40 GTV	AS2	
Carbide seat with seal + Diffuser	2	✓	✓	✓					129.740.908
Stainless steel seat	2	✓	✓	✓					129.729.905
Stainless steel seat + Diffuser	2	✓	✓	✓					129.740.909
Acetal Seat	10	✓	✓	✓					129.729.904
Diffuser	10	✓	✓	✓					129.740.910
Carbide seat assembly (with holder) (mounted on standard)	1	✓ <sup>(1)</sup>	✓ <sup>(1)</sup>	✓ <sup>(1)</sup>					129.740.040
	1		-	-		✓ <sup>(1)</sup>		✓ <sup>(1)</sup>	129.461.300
SST seat assembly (with holder) (mounted on standard)	1	✓	✓	✓	✓ <sup>(1)</sup>		-		630.387
	1		-	-			✓ <sup>(1)</sup>		129.982.040
Acetal seat assembly (with holder) (mounted on standard)	1	✓	✓	✓			-		129.980.100
	1	✓	✓	✓			-		129.982.070

(1) : Mounted on standard

## Tip seals

Description	Tip Top	Skill™	Flat	Part number
Pack of 10 seals	✓	-		134.740.007
Servicing kit(Pack of 4 seat and seal assembled)	✓	-		129.740.907
Pack of 10 collars for Skill™ tips		✓	-	134.980.002
Pack of 10 collars with integrated micro-screen for Skill™ tips caliber #04 & 06		✓		134.980.010
Pack of 10 micro-screen		✓		129.609.901
Pack of 5 seals for flat tip		-	✓	150.041.319

## Pre-orifice for AIRLESS® gun

Mounted before an AIRLESS® tip to improve the quality of AIRLESS® atomization. Reduces spray atomization pressure.

Used with tip size in (mm)	Marking	Part number
0.007 - 0.009 (0.17 - 0.22)	9	500109
0.011 (0.27)	13	500113
0.013 - 0.015 (0.33 - 0.38)	16	500116
0.016 - 0.018 - 0.020 - 0.021 (0.40 - 0.45 - 0.50 - 0.53)	25	500125
0.024 (0.60) and +	39	500139

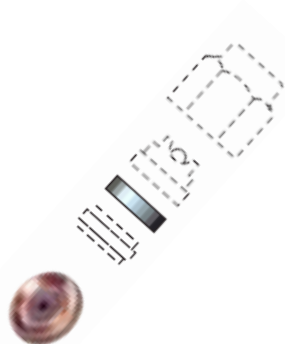

# Accessories for AIRLESS® guns

## Unplugging needles for flat tips

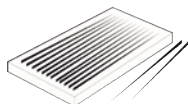

Description	Tip size (mm)	Quantity	Part number
Unplugging needles	≤ 0.9	12	000.094.000
	≥ 0.9		000.094.002

## Swivel fitting



Description	Maximum fluid pressure (bar)	Thread		Part number
		Inlet	Outlet	
Twist swivel fitting	500	M 1/2" JIC	F 1/2" JIC	129.670.425
		M 1/4" NPSM	F 1/2" JIC	129.670.435

## In-line paint filter

With its compact dimensions, it fits on base of the handle or between two hoses.



Description	Set-up	Maximum fluid pressure (bar)	Thread		Part number
			Inlet	Outlet	
Stainless steel filters supplied with 6 screen - 168µ	Between 2 hoses	200	M1/2 JIC	M1/2 JIC	155.010.000
	At the gun fluid inlet		M1/2 JIC	F1/2 JIC	155.010.100

## Gun screen filter (Compatible for Sflow™, ASB and ASC)

Screen in stainless steel for deflector	Size (µm)	Quantity	Part Number
N° 4	100	5	129.982.021
N° 6	168	5	129.982.022
N° 12	280	5	129.982.023

# Maintenance kit for old automatic guns

## Maintenance kit for ASI 24 & ASI40 gun

Description	Part number
Seal kit	129.980.901
GT packing	129.980.310
Needle line	033.980.100

## Maintenance kit for ASI40 GT & ASI40 GTV gun

Description	Part number
Seal kit	129.980.901
Fluid packing assembly	129.971.102
Pack of 50 needles	129.980.520

## Maintenance kit for AS2 gun

Description	Part number
PTFE cartridge assembly	129.973.100
Needle	000.152.208
Carbide seat	129.461.300
SOFT seat	129.461.305

## Diaphragm for ASI Range and AS2 spray gun

A diaphragm has to be chosen depending on the tip size. It increases the quality of atomization. It is installed before the tip and his seal

Description	For tip size	fitting	Part Number
Diaphragm 12	03 to 06	M11/16"	000.029.112
Diaphragm 15	09 to 12	M11/16"	000.029.115
Diaphragm 18	14 to 18	M11/16"	000.029.118
Diaphragm 20	20	M11/16"	000.029.120
Diaphragm 25	30	M11/16"	000.029.125
Diaphragm 60 - mounted on standard	-	M11/16"	000.029.160
Diaphragm 60 - For M25x175 guard	-	M25x175	129.740.074

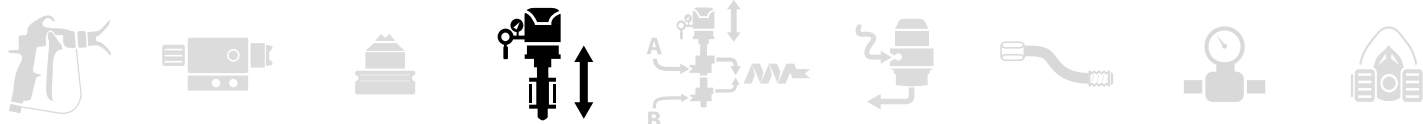

## Cup pumps

➤ An Airless spraying system is included the following equipment list (at minimal):

- A pump
- 1 Fluid hose
- A gun

➤ Every of our Airless pumps, hereafter detailed, are built in the same way:

1. One Pneumatic air motor
2. One hydraulic section.
3. One manometer to pilote the compressed air entering the engine



The role of a pump is to suck the fluid from the drum and exhaust it under high pressure to the gun through an hose.

**SAMES KREMLIN** is a world leader in pneumatic piston pump manufacturing which is the benchmark technology in the industry for many reasons:

- No risk of fire in the presence of solvent vapors.
- Very high pressure even with the most viscous products.
- Continuous feed without flow variation (*thanks to double-acting operation*), ideal to guarantee consistency of thickness and high finishing result.

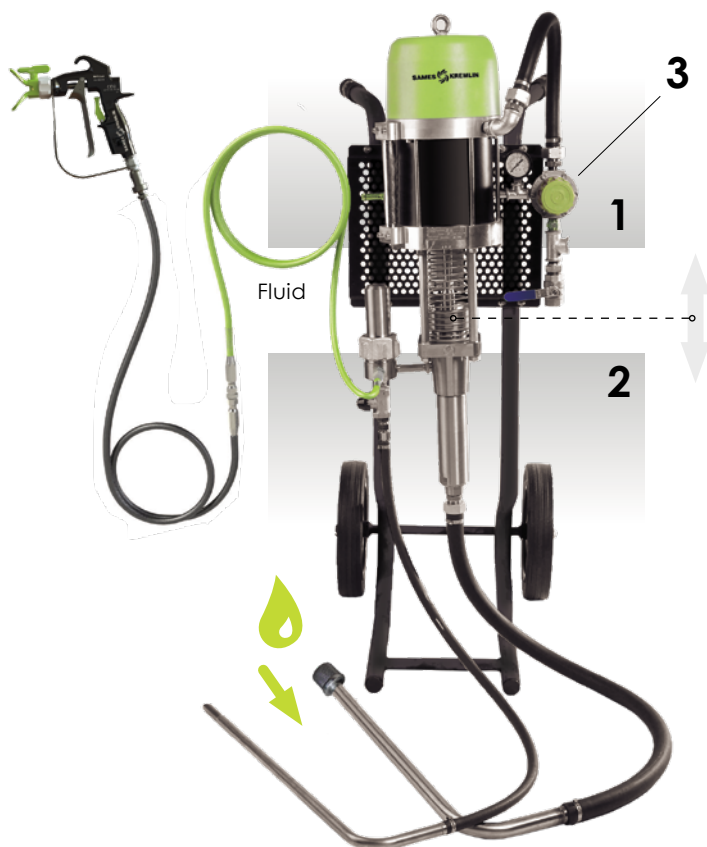

Then, pump accessories can be added as standard or optional to complete the equipment:

- Suction elements: suction tube with a selection of different diameter or gravity hopper
- Filter at the pump outlet with purge rod - to limit nozzle clogging and to facilitate the priming/ flushing of your equipment.
- Wall mounted frame, trolley or tripod.

### A pump must be selected according 2 essential parameters:

- The pressure ratio, brings the necessary power to transport the Fluid and to atomize it
- The hydraulic section size, which will allow the feeding of 1 or several guns

Selecting the correct pump for your application and adapted to your material requires know-how and our local SAMES KREMLIN teams are there to help you. It is important to mention that all our pumps are compatible with solvent and water-based materials.

➤ The following chapter introduces you to our range of cup pumps. These pumps are built with a cup on top of the hydraulics which have to be filled with lubricant.

This lubricant ensures constant piston lubrication and must be compatible with the pumped material.



This **Cup-lub pump technology** has many advantages:

- Increases the pump lifetime: the lubricant prevents any paint drying on the piston
- Represents a visual leak indicator, alerting the user of the need to retighten the seal or to charge them
- Limits heating of the piston

Finally, our know-how is to propose a multitude of pump's option to prolong their lifespan whatever the material used and your constraints of application:

- Choice of different seals, GT, PFA, PU, MB-A, PTFE G, UHMW, Leather, Polyfluid, the table below will help you in your choice
- Ball valve option in stainless steel 316 or 316L, carbide or in ceramic
- Engine with anti-icing Turbo option

It's a safe bet that you will find the pump you need in the following pages

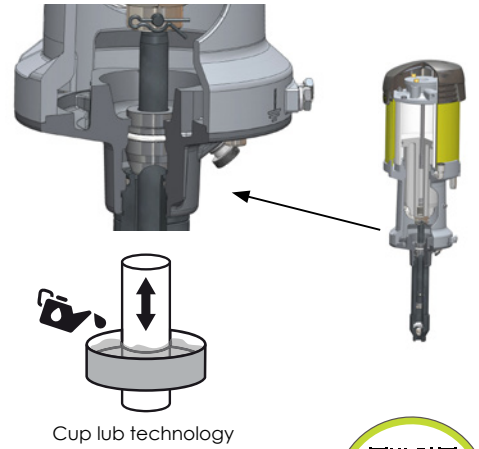

Cup lub technology



**Selection table per features**

FEATURES	BENEFITS	10C18	15C25	15C50	30C25	35C50	40C50	40C50WB	40C100	40C100WB	40C260	Azur™ 52C225 / 72C160	65C260	80C220
Stainless steel design	Compatible with water-based and solvent-based materials								✓					
Simple design, reduced number of spare parts	Easy maintenance		✓				✓		✓	✓	-	✓	-	✓
Compact design	Fits in small working areas			✓			-	-	-	-	-	-	-	-
large diameter suction rod and high compression ratio	Can be used with a wide range of materials	-	-	-	-	✓	✓	✓	✓	✓	✓	✓	✓	✓
Fluid section with mobile lower packing construction	Improved material refilling and emptying for constant output improved sealing - easier maintenance	-	✓	✓	✓	✓	✓	✓	✓	✓	✓	✓	✓	✓
Simple and accessible air motor/fluid section coupling without tie rod	Possibility to rotate the fluid section to adjust the	-	✓	✓	✓	✓	-	-	-	-	-	-	-	-
Double stroke fluid section	fluid output on the application	-							✓					
Closed design with protective carrier between air motor and fluid section	lubricant protection against external pollution Full operator safety			✓			-	-	-	-	-	✓*	-	-
Progressive start up with very low air pressure	Easy priming at very low fluid discharge pressure. No pulsation even with 0.5 bar of air			✓			-	-	-	-	-	✓	-	-
Puls-Absorber™ technology	Stable and smooth flow	-	-	-	-	-	-	✓	-	✓	-	✓	-	-
Stainless steel strainer	Long service life and good reliability. No crushing possible			✓			-	✓	-	✓	-	✓	-	-
Rugged design	Excellent performances and easy maintenance in hard to reach places	-	-	-	-	-	-	-	-	-	✓	✓	✓	✓
Air motor muffler included	Very silent pump for better comfort of the operator	-	-	-	-	-	-	-	-	-	✓	✓	✓	-
High pressure ratio	High power, compatible with long hose lengths	-	-	-	-	-	-	-	-	-	-	✓	✓	✓
VDE technology	Reduced noise pollution due to an enhanced exhaust/muffler technology	-	-	-	-	-	-	-	-	-	-	✓	-	-
	Reduced ising potential	-	-	-	-	-	-	-	-	-	-	✓	-	-
	Stalling free : Fast pump changer over design to eliminate pulsation during application	-	-	-	-	-	-	-	-	-	-	✓	-	-
Sprayed material	Waterbased	✓	✓	✓	✓	✓	✓	✓	✓	✓	✓	✓	✓	✓
	Solvent base	✓	✓	✓	✓	✓	✓	✓	✓	✓	✓	✓	✓	✓
	Primers	✓	✓	✓	✓	✓	✓	✓	✓	✓	✓	✓	✓	✓
	Zinc charged primer	-	-	-	-	-	-	-	-	-	-	-	-	-
	Stains	✓	✓	✓	✓	-	-	-	-	-	-	-	-	-
	Direct Gloss / Metallic	-	-	-	-	-	-	-	-	-	-	-	-	-
	Top coats	✓	✓	✓	✓	✓	✓	✓	✓	✓	✓	✓	✓	✓
	UV products	-	-	-	-	-	-	-	-	-	-	-	-	-
	Moisture sensitive	-	-	-	-	-	-	-	-	-	-	-	-	-
	Two components	✓	✓	✓	✓	✓	✓	✓	✓	✓	✓	✓	✓	✓
	Protective coating / abrasives	-	-	-	-	✓	-	✓	-	✓	✓	✓	✓	✓
	Adhesives	-	-	-	-	-	✓	✓	✓	✓	✓	✓	✓	✓
	Silicone	-	-	-	-	-	-	-	-	-	-	-	-	✓
	Sealants	-	-	-	-	-	-	-	-	-	-	-	-	✓
Greases	-	-	-	-	-	-	-	-	-	-	-	-	✓	
Wax	-	-	-	-	-	-	-	-	-	-	-	-	-	

✓ available  
✓\* optional

# Selection table of Cup pumps

## Selection table per technicity

Pump name	10C18	15C25	15C50	30C25	35C50	40C50	40C50WB	
<b>Construction</b>								
Stainless Steel	✓	✓	✓	✓	✓	✓	✓	
Upper sealing available	GT cartridge	✓	✓	-	✓	-	✓*	
	MB-GT cartridge	-	-	✓*	-	✓*	-	
	MB-A cartridge	-	✓	✓	✓	✓	-	
	PTFE G + Polyfluid	-	-	-	-	-	✓	
	PTFE G + PE	-	-	-	-	-	-	
	PE	-	-	-	-	-	✓	✓
	Leather + PE	-	-	-	-	-	-	-
	PU	-	-	-	-	-	-	-
	PTFE	-	-	-	-	-	-	-
	PTFE + PE	-	-	-	-	-	-	-
Lower sealing available	PU + PE + Acetal resin	-	-	-	-	-	-	
	PU	✓	-	-	-	-	-	
	GT	✓*	✓	✓	✓	✓	✓	
	UHMW polyethylene	-	-	-	-	-	-	
	PTFE G + PE	-	-	-	-	-	*	
	PTFE	-	-	-	-	-	-	
	PTFE + PE	-	-	-	-	-	-	
Ball	Leather + PE	-	-	-	-	-	-	
	PTFE G	-	-	-	-	-	-	
	Stainless steel	-	✓	✓	✓	✓	✓	
	316	✓	-	-	-	-	✓	
Carbide	-	-	-	-	-	-	-	
Ceramic	✓*	-	-	-	-	-	-	
<b>Assembling</b>								
Bare	-	-	-	-	-	✓	-	
Wall mounted	✓	✓	✓	✓	✓	✓	✓	
Cart mounted	✓*	✓*	✓*	✓*	✓*	✓	✓	
<b>Dimension (wall mounted pump without filter or suction rod)</b>								
Height (mm)	390	585	585	585	600	800	920	
Width (mm)	270	158	159	158	230	400	400	
Depth (mm)	150	170	160	170	230	280	280	
Weight (kg)	5,3	7,6	8	7,6	12	22	22	
<b>Characteristics</b>								
Pressure ratio	10/1	15/1		30/1	35/1	40/1	40/1	
Output per cycle (cc)	18	25	50	25	50	50	50	
Number of cycle (per liter)	55	40	20	40	20	20	20	
Output at 30 cycles/min (L)	0,55	0,75	1,5	0,75	1,5	1,5	1,5	
Free flowrate (L/min)	1,1	1,5	3	1,5	3	3	3	
Max fluid pressure (bar)	60	90	90	180	210	240	240	
Max Paint temperature (°C)	60	60	60	60	60	60	60	
Operating air pressure (bar)	1-6	1-6	1-6	1-6	1-6	1-6	1-6	
Air consumption at 30 cyc/ min and 4 bar (m(3)/h)	1,9	2,8	8,1	7,1	18,9	21,6	21,6	
<b>Fittings</b>								
Air inlet	F 3/8 BSP							
Fluid Inlet - Bare pump	F 1/2 BSP	F 1/2 BSP	F 1/2 BSP	M 26x125	F 1/2 BSP	F 1/2BSP	F 1"	
Fluid inlet - Assembled pump	-	M26x125	M26x125	M 26x125	M26x125	M 26x125	M 1"	
Fluid Outlet - Bare pump	-	-	F 3/8 NPS	-	F 3/8 NPS	F 3/8 NPS	F 3/8 NPS	
Fluid Outlet - Assembled pump	M 1/2 JIC					M 1/2 JIC (filter output)	M 1/2 JIC (filter output)	

✓ available

✓\* optional



# Selection table of Cup pumps

Pump name		40C100	40C100WB	40C260	Azur™ 52C225 / 72C160	65C260	80C220	
<b>Construction</b>								
Stainless Steel		✓	✓	✓	✓	✓	✓	
Upper sealing available	GT cartridge	✓*	-	✓	-	✓*	-	
	MB-GT cartridge	-	-	-	-	-	-	
	MB-A cartridge	-	-	-	-	-	-	
	PTFE G + Polyfluid	✓	✓	-	-	-	-	
	PTFE G + PE	-	-	✓	✓	✓	-	
	PE	✓*	✓*	-	-	-	-	
	Leather + PE	-	-	-	✓	-	✓	
	PU	✓*	✓*	✓	-	✓*	-	
	PTFE	-	-	-	-	-	✓	
	PTFE + PE	-	-	-	✓	-	✓*	
	PTFE G	-	-	-	-	-	✓*	
	PU + PE + Acetal resin	-	-	-	-	-	✓*	
	Lower sealing available	PU	✓*	✓*	✓	-	✓*	-
		GT	✓	✓	✓	-	✓	-
UHMW polyethylene		-	-	-	-	-	-	
PTFE G + PE		✓*	-	-	-	-	✓*	
PTFE		-	-	-	-	-	✓*	
PTFE + PE		-	-	-	✓	-	✓*	
Leather + PE		-	-	-	✓	-	✓*	
Ball	PTFE G	-	-	-	-	-	✓*	
	Stainless steel	✓	✓	✓	✓	✓	✓	
	316	✓*	-	-	-	-	-	
	Carbide	-	-	-	✓*	-	-	
	Ceramic	-	-	-	✓*	-	-	
<b>Assembling</b>								
Bare		✓	-	-	✓	-	-	
Wall mounted		✓	✓	✓	✓	✓	-	
Cart mounted		✓	✓	✓	✓	✓	✓	
<b>Dimension (wall mounted pump without filter or suction rod)</b>								
Height (mm)		800	920	1080	1132	1120	1360	
Width (mm)		400	400	640	317	480	740	
Depth (mm)		280	280	325	425	500	830	
Weight (kg)		22	22	110	60,4	86	125	
<b>Characteristics</b>								
Pressure ratio		40/1	40/1	40/1	52/1 // 72/1	65/1	80/1	
Output per cycle (cc)		100	100	240	225 / 160	260	220	
Number of cycle (per liter)		10	10	4	4.5 / 6	4	4.5	
Output at 30 cycles/min (L)		3	3	7,2	6.75 / 4.8	7,8	6,6	
Free flowrate (L/min)		6	6	14,4	13.5 / 9.6	14,4	13,6	
Max fluid pressure (bar)		240	240	240	312 / 432	390	480	
Max Paint temperature (°C)		60	60	60	60	60	60	
Operating air pressure (bar)		1-6	1-6	1-6	1-6	1-6	1-6	
Air consumption at 30 cyc/min and 4 bar (m(3)/h)		43,2	43,2	96,8	126 / 124	157,3	190	
<b>Fittings</b>								
Air inlet		F 3/4 BSP	F 3/4 BSP	F 3/4 BSP	M 3/4 BSP	F 3/4 BSP	F 3/4 BSP	
Fluid Inlet - Bare pump		F 1/2BSP	F 1"	F 1"	M 3/4" BSP	F 1"	F 1"	
Fluid inlet - Assembled pump		M 26x125	M 1"	M 38 x 150 Elbow	M 1" 1/4 BSP	M 38 x 150 Elbow	M 1" Elbow	
Fluid Outlet - Bare pump		F 3/8 NPS	F 3/8 NPS	F 3/4 NPS	F 3/4 BSP	F 3/4 NPS	F 1"	
Fluid Outlet - Assembled pump		M 1/2 JIC (filter output)	M 3/4 JIC (filter output)	M 3/4 JIC	M 3/8 NPSM	M 3/4 JIC	M 3/4 JIC	

✓ available  
 ✓\* optional

# 10C18

The 10C18 Airless Fine Finish painting pump is only available as a complete spraying package. It ensures constant and pulse free delivery for superior finish.

- **Designed for long-lasting industrial use**
- **Fast color changes with minimum solvent consumption**
- **Simple design to minimize maintenance time and operation**

COMPACT DESIGN ENSURING CONSTANT DELIVERY AND PULSE FREE FOR SUPERIOR FINISH



## Configuration of the 10C18 Airless paint pump

The 10C18 is only available under spray pack, please refer to chapter "Table of spray pack", page 11, for part number list

## Maintenance kits

Description	Part number
Repair kit for 340/2 air motor	144.850.150
C18 fluid section repair kit	144.855.799
* PU red seal for exhaust valve - recommended for water-based materials	144.855.704

## Accessories

Description	Part number
Tripod	151.665.705
Single Post Cart	051.730.110
Handle	051.665.651
Suction rod Ø6.35 plunging tube length 420mm	151.665.640
Easyflush suction rod Ø16 plunging tube length 600 mm	149.596.050
Easyflush suction rod Ø16 plunging tube length 1000mm (for 200 liters drums)	149.596.060

# 15C25



The compact Airless painting pump is the ideal partner for your Airless spray guns, providing exceptional finish quality & high transfer efficiency.

- **Efficiency:** perfect for Airless fine finish
- **Optimization:** built with minimal parts
- **Simplicity:** lowest cost of ownership

ACCELERATOR OF PERFORMANCE



## Configuration of Airless 15C25 paint pump

Set-up	Cartridge	fluid inlet fitting	Suction rod	drain rod	Atomizing air regulator	Fluid pressure regulator	Filter pump outlet	Part number
Airless 15c25	GT	M 26x125	∅ 16	-	-	✓	-	151.140.300
	MB-A	M 26x125	∅ 16	-	-	✓	-	151.140.650

## Maintenance kits

Description	Part number
Servicing kit - Motor 245-4	144.140.190
Servicing kit - hydraulic C25	144.130.291
GT cartridge	144.130.205
MB-A Cartridge	144.130.365
Piston assembly and MB-A cartridge	144.130.389

## Accessories

Description	Part number
Wall-mounted totem	151.140.240
Stand	151.140.210
Double Post Cart	151.241.000
Gravity Hopper 6 liters	151.140.230
Easyflow suction rod ∅25 plunging tube length 600 mm	149.596.150
Easyflow suction rod ∅25 plunging tube length 1000mm (for 200 liters drums)	149.596.160
Stainless steel drain rod F18 x 125	049.596.000
Fluid filter	155.580.600
Air plate with 1 air regulator	151.140.060

\*: +/- 2% according to norm (EN 13966-1)

# 15C50

The compact Airless paint pump is the ideal partner for your Airless spray guns providing exceptional finish quality & high transfer efficiency.

- Perfect Airless fine finish application
- Built with minimal parts
- Lowest cost of ownership

ACCELERATOR OF PERFORMANCE



### Configuration of the 15C50 Airless paint pump

Set-up	Cartridge	fluid inlet fitting	Suction rod	Drain rod	Atomizing air regulator	Fluid pressure regulator	Filter pump outlet	Part number
Airless 15C50	GT	F 1/2 BSP	-	-	-	✓	-	151.145.500

### Maintenance kits

Description	Part number
Servicing kit - Motor 420-4	144 130 190
Servicing kit - Hydraulic C50	144 135 237
GT cartridge	144 135 205
MB-A Cartridge	144 135 365
Piston assembly and GT cartridge	144 135 291
Piston assembly and MB-A cartridge	144 135 389

### Accessories

Description	Part number
Wall-mounted totem	151.140.240
Stand	151.140.210
Double Post Cart	151.241.000
Gravity Hopper 6 liters	151.140.230
Easyflow suction rod Ø25 plunging tube length 600 mm	149.596.150
Easyflow suction rod Ø25 plunging tube length 1000mm (for 200 liters drums)	149.596.160
Stainless steel drain rod F18 x 125	049.596.000
Fluid filter	155.580.600
Air plate with 1 air regulator	151.140.060

# 30C25



This compact Airmix® paint pump is the ideal partner for your Airmix® spray guns providing exceptional finish quality & high transfer efficiency.

- Efficiency - perfect for Airless fine finish application
- Optimization - built with minimal parts
- Simplicity - lowest cost of ownership

ACCELERATOR OF PERFORMANCE



### Configuration of the 30C25 Airless paint pump

Set-up	Cartridge	fluid inlet fitting	Suction rod	drain rod	Atomizing air regulator	Fluid pressure regulator	Filter pump outlet	Part number
Airless 30C25	GT	M26x125	-	-	-	✓	-	151.145.050
Airless 30C25	MB-A	M26x125	-	-	-	✓	-	151.145.500
Airless 30C25	GT	M26x125	ø25	-	-	✓	✓	151.145.300
Airless 30C25	MB-A	M26x125	ø25	-	-	✓	✓	151.145.750

### Maintenance kits

Description	Part number
Servicing kit - Motor 245-4	144.140.190
Servicing kit - hydraulic C25	144.130.291
GT cartridge	144.130.205
MB-A Cartridge	144.130.365
Piston assembly and MB-A cartridge	144.130.389

### Accessories

Description	Part number
Wall-mounted totem	151.140.240
Stand	151.140.210
Double Post Cart	151.241.000
Gravity Hopper 6 liters	151.140.230
Easyflow suction rod Ø25 plunging tube length 600 mm	149.596.150
Easyflow suction rod Ø25 plunging tube length 1000mm (for 200 liters drums)	149.596.160
Stainless steel drain rod F18 x 125	049.596.000
Fluid filter	155.580.600
Air plate with 1 air regulator	151.140.060

# 35C50



The 35C50 Airless paint pump ensures constant and pulse-free delivery for superior, industrial finishing.

- Designed for long-lasting industrial use
- Fast color changes with minimum solvent consumption
- Simple design to minimize maintenance time and operation

ACCELERATOR OF PERFORMANCE



### Configuration of the 35C50 Airless paint pump

Set-up	Cartridge	fluid inlet fitting	Suction rod	Drain rod	Atomizing air regulator	Fluid pressure regulator	Filter pump outlet	Part number
Airless 35C50	MB-A	F 1/2"	-	-	-	✓	-	144.148.150
	MB-A	M26x125	-	-	-	✓	-	151.148.200
	MB-A	M26x125	ø25	-	-	✓	-	151.148.300
	MB-A	M26x125	ø25	-	-	✓	✓	151.148.350

### Maintenance kits

Description	Part number
Servicing kit - Motor 970-4	144 160 191
Servicing kit - Hydraulic C50	144 135 237
GT cartridge	144 135 205
MB-A Cartridge	144 135 365
Piston assembly and GT cartridge	144 135 291
Piston assembly and MB-A cartridge	144 135 389

### Accessories

Description	Part number
Wall-mounted totem	151.140.240
Stand	151.140.210
Double Post Cart	151.241.000
Gravity Hopper 6 liters	151.140.230
Easyflow suction rod Ø25 plunging tube length 600 mm	149.596.150
Easyflow suction rod Ø25 plunging tube length 1000mm (for 200 liters drums)	149.596.160
Stainless steel drain rod F18 x 125	049.596.000
Fluid filter	155.580.600
Air plate with 1 air regulator	151.140.060

# 40C50

This paint pump is the perfect pump for Airless® applications.

- Ideal for Airless applications
- High efficiency pump for maximum energy savings
- Optimized construction for simple & quick maintenance

PRODUCTIVITY FOR ALL



### Configuration of the 40C50 Airless paint pump

Set-up	Suction rod (ø 25)	Drain rod	Atomizing air regulator	Fluid pressure regulator	Filter pump outlet	Part number
40C50 bare pump	M26x125	-	-	-	-	144.148.150
Wall mounted	-	-	-	✓	-	151.775.050
Wall mounted	✓	✓	-	✓	-	151.775.100
Wall mounted	-	✓	-	✓	✓	151.775.150
Wall mounted	✓	✓	-	✓	✓	151.775.200
2 arm cart mounted	✓	✓	-	✓	✓	151.775.400

### Maintenance kits

Description	Part number
Seals kit - 1000-4 air motor	146.270.991
Servicing kit - 1000-4 air motor	146.270.995
Seals kit - C50 with upper Polyfluid & lower GT	144.950.091
Servicing kit - C50 with upper Polyfluid & lower GT	144.950.096
Seals kit - C50 with upper & lower GT	144.950.090
Servicing kit - C50 with upper & lower GT	144.950.095

### Accessories

Description	Part number
Two Post Cart w/o plate	051.221.000
Two Post Pump Mounting Plate	056.100.199
Easyflow suction rod Ø25 plunging tube length 600 mm	149.596.150
Easyflow suction rod Ø25 plunging tube length 1000mm (for 200 liters drums)	149.596.160
Stainless steel flushing rod F18 x 125	049.596.000
Filter	155.580.400

Spray guns

Pumps

Machines & Controllers

Accessories

General informations

# 40C50 WB

This water-based paint pump provides exceptional performance for high viscosity paints.

- Ideal for Airless water-based applications
- High efficiency pump for maximum energy savings
- Optimized construction - simple & quick maintenance

ACCELERATOR OF PERFORMANCE



## Configuration of the 40C50 WB Airless paint pump

Set-up	Suction rod (Ø 1")	Drain rod	Air regulator Fluid pressure	Pump output filter	Part number
Wall mounted	✓	✓	✓	✓	151.775.550
2 arms cart mounted	✓	✓	✓	✓	151.775.500

## Maintenance kits

Description	Part number
WB seal kit	144.950.991
Repair kit	144.950.992
Seal kit for 1000-4 air motor	146.270.991
Repair kit for 1000-4 air motor	146.270.995

## Accessories

Description	Part number
Two Post Cart w/o plate	051.221.000
Two Post Pump Mounting Plate	056.100.199
Suction rod 1"	921.270.101
Stainless steel flushing rod F18 x 125	049.596.000
Filter	155.580.400



# 40C100

This paint pump is perfect for Airless applications and provides exceptional performance.

- Ideal for Airless applications
- High efficiency pump for maximum energy savings
- Optimized construction - simple & quick maintenance



Spray guns

Pumps

Machines & Controllers

Accessories

General informations

## Configuration of the 40C100 Airless paint pump

Set-up	Suction rod (Ø 25)	Drain rod	Air regulator Fluid pressure	Pump output filter	Part number
40C100 bare pump	M 26 x 125	-	-	-	151.785.000
Wall mounted	-	-	✓	-	151.785.050
Wall mounted	✓	-	✓	-	151.785.100
Wall mounted	-	✓	✓	✓	151.785.150
Wall mounted	✓	✓	✓	✓	151.785.200
2 arms cart mounted	✓	✓	✓	✓	151.785.400

## Maintenance kits

Description	Part number
Seals kit - 2000-4 air motor	146 270 990
Servicing kit - 2000-4 air motor	146 270 996
Seals kit - C100 with upper Polyfluid & lower GT	144 960 091
Servicing kit - C100 with upper Polyfluid & lower GT	144 960 096
Seals kit - C100 with upper Polyfluid & lower chevron	144 960 090
Servicing kit - C100 with upper Polyfluid & lower chevron	144 960 095
Servicing kit - C100 with upper Polyfluid & lower chevron	144 960 095
Servicing kit - C100 with upper & lower PU - H2O Application	144 960 159

## Accessories

Description	Part number
Two Post Cart w/o plate	051.221.000
Two Post Pump Mounting Plate	056.100.199
Easyflow suction rod Ø25 plunging tube length 600 mm	149.596.150
Easyflow suction rod Ø25 plunging tube length 1000mm (for 200 liters drums)	149.596.160
Stainless steel flushing rod F18 x 125	049.596.000
Filter	155.580.400

# 40C100 WB

This water-based (WB) type paint pump provides exceptional performance for high viscosity paints.

- Ideal for Airless water-based applications
- High efficiency pump for maximum energy savings
- Optimized construction - simple & quick maintenance



## Configuration of the 40C100 WB Airless paint pump

Set-up	Suction rod (Ø 1")	Drain rod	Air regulator Fluid pressure	Pump output filter	Part number
Wall mounted	-	-	✓	-	151.785.510
Wall mounted	-	✓	✓	✓	151.785.520
Wall mounted	✓	✓	✓	✓	151.785.550
2 arms cart mounted	✓	✓	✓	✓	151.785.500

## Maintenance kits

Description	Part number
WB seal kit	144.960.891
WB repair kit	144.960.892
Seal kit for 2000-4 air motor	146.270.990
Repair kit for 2000-4 air motor	146.270.996

## Accessories

Description	Part number
Adaptator stainless steel F 3/4" JIC/M 1/2" JIC	905.160.219
Two Post Cart w/o plate	051.221.000
Two Post Pump Mounting Plate	056.100.199
Suction rod 1"	921.270.101
Stainless steel flushing rod F18 x 125	049.596.000
Filter	155.581.400

# 40C260

This Airless® 40C260 High Pressure Pump is designed for the application of water or solvent based with medium to high viscosity materials.

- All stainless steel construction
- High output pump
- Very simple and fast servicing



Spray guns

Pumps

## Configuration of the 40C260 Airless paint pump

Set-up	Upper sealing	Lower sealing	Suction rod (1")	Drain rod	Air regulator Fluid pressure	Pump output filter	Part number
Wall mounted	PTFE G + PE	GT	-	-	✓	-	151.870.500
Wall mounted	PTFE G + PE	GT	-	-	✓	✓	151.870.800
Wall mounted	GT	GT	-	-	✓	✓	151.870.670
Wall mounted	PU	PU	-	-	✓	✓	151.870.660
Wall mounted	PTFE G + PE	GT	✓	-	✓	✓	151.870.600
Cart-mounted	PTFE G + PE	GT	✓	-	✓	✓	151.870.700

## Maintenance kits

Description	Part number
Seal kit 5000-4_2 air motor	146.280.991
Servicing kit 5000-4_2 air motor	146.280.996
Seal kit C260 upper PTFE G - PE & lower GT	144.025.090
Seal kit C260 PU (upper & lower)	144.025.691
Seal kit C260 GT (upper & lower)	144.025.693
Servicing kit C260 upper PTFE G - PE & lower GT	144.025.695
Servicing kit C260 PU (upper & lower)	144.025.692
Servicing kit C260 PU (upper & lower)	144.025.694
Conversion kit from old to new generation of Hydraulic C260	151.870.499
Complete PU cartridge	144.710.200

## Accessories

Description	Part number
Two Reinforced Arms w/o mounting plate	051.231.000
Pump bracket	051.341.206
Suction rod Ø1"	921.270.101
Stainless steel flushing rod F18 x 125	049.596.000
Pack of 2 U-bolts, 4 washers, 4 nuts	151.730.114
Fluid filter	155.581.400
Adaptor Stainless steel F 3/4" JIC/M 1/2" JIC	905.160.219

Machines & Controllers

Accessories

General informations

# Azur™ 52C225



Azur™ range is the recommended line for the protective coatings market. The pump will transfer material without compromising your finish quality whether you are using single component paints, pre-mixed 2K, zinc-rich materials, and other types of coatings.

- High finishing protective coatings applications
- Designed to operate well in harsh and intensive environments
- Simple maintenance and comfortable to use

ADDICTED TO WORK



## Configuration of the Azur™ 52C225 Airless protective coating pump

	Sealing			Air regulator Fluid pressure	Suction			Output filter	Part Number
		Wall mounted	Trolley		Hose 600 mm	Hose 1000 mm	Gravity hopper		
BARE		-	-	-	-	-	-	-	64350225130000
W/M SUC 30L W/O FILT	#03 - UHMWPE +PTFE	✓	-	✓	✓	-	-	-	64350225131101
W/M SUC 200L W/O FILT		✓	-	✓	-	✓	-	-	64350225135101
W/M SUC 200L FILT SST		✓	-	✓	-	✓	-	✓	64350225135111
MOB SUC 30L FILT SST		-	✓	✓	✓	✓	-	✓	64350225131115
MOB HOPPER FILT SST		-	✓	✓	✓	-	-	✓	64350225134115

## Maintenance kits

Description	Part number
Air motor seals kit	146.371.040
C225 Servicing kit (does not include seals)	144.050.225
C225 Seal kit - All purpose - #03 - UHMWPE+PTFE	144.050.313
C225 Seal kit - Abrasive - #04 - UHMWPE+Leather	144.050.314
C225 Seal kit - Warm - #05 - UHMWPE+PTFE G	144.050.315

## Accessories

Description	Part number
Suction rod 1"1/4 L=600 mm	149.597.200
Suction rod 2" L=600 mm	149.597.210
Suction rod 1"1/4 L=1000 mm	149.597.250
Priming kit (without filter) for 3/8" hoses	151.590.012
SST Equipped filter	155.581.456
Heavy duty trolley	151.590.700
Gravity hopper 20L	125.010.000
Magma heater range (refer to <b>page 66</b> for P/N detail)	156.160.0XX
Kit 1 sprayer : SFlow™ 470 with Tip Top 18-13 (519) - 1.6M + 1.6M hoses + fittings	151.590.016
14 Seals PTFE G	144.050.326
14 Seals PTFE	144.050.325
14 Seals Leather	144.050.324
14 Seals UHMWPE	144.050.323

# 65C260

This Airless® 65C260 High Pressure Pump is designed for the application of water or solvent-based with medium to high viscosity materials.

- All stainless steel construction
- High output pump
- Very simple and fast servicing



## Configuration of the 65C260 Airless paint pump

Set-up	Suction rod (Ø25)	Drain rod	Air regulator Fluid pressure	Pump output filter	Part number
Wall mounted	✓	-	✓	✓	151.880.600
Cart-mounted	✓	-	✓	✓	151.880.700

## Maintenance kits

Description	Part number
Seal kit 8000-4-2 air motor	146.258.991
Servicing kit 8000-4-2 air motor	146.258.996
Seal kit C260 upper PTFE G - PE & lower GT	144.025.090
Seal kit C260 PU (upper & lower)	144.025.691
Seal kit C260 GT (upper & lower)	144.025.693
Servicing kit C260 upper PTFE G - PE & lower GT	144.025.695
Servicing kit C260 PU (upper & lower)	144.025.692
Servicing kit C260 PU (upper & lower)	144.025.694
Conversion kit from old to new generation of Hydraulic C260	151.870.499

## Accessories

Description	Part number
Two Reinforced Arms w/o mounting plate	051.231.000
Pump bracket	051.341.206
Suction rod Ø25 plunging tube length 600 mm	049.597.100
Stainless steel flushing rod F18 x 125	049.596.000
Pack of 2 U-bolts, 4 washers, 4 nuts	151.730.114
Fluid filter	155.581.400
Adaptor Stainless steel F 3/4" JIC/M 1/2" JIC	905.160.219

Spray guns

Pumps

Machines & Controllers

Accessories

General informations

# Azur™ 72C160



Azur™ range is the recommended line for the protective coatings market. The pump will transfer material without compromising your finish quality whether you are using single component paints, pre-mixed 2K, zinc-rich materials, and other types of coatings.

- High finishing protective coatings applications
- Designed to operate well in harsh and intensive environments
- Simple maintenance and comfortable to use

ADDICTED TO WORK



## Configuration of the Azur™ 72C160 Airless protective coating pump

	Sealing			Air regulator Fluid pressure	Suction			Output filter	Part Number	
		Wall mounted	Trolley		Hose 600 mm	Hose 1000 mm	Gravity hopper			
BARE		-	-	-	-	-	-	-	64350160130000	
W/M SUC 30L W/O FILT		✓	-	✓	✓	-	-	-	64350160131101	
W/M SUC 30L FILT SST	#03 - UHMWPE +PTFE	✓	-	✓	✓	-	-	✓	64350160131111	
W/M SUC 200L FILT SST		✓	-	✓	-	✓	-	✓	64350160135111	
MOB SUC 30L FILT SST		-	✓	✓	✓	✓	-	-	✓	64350160131115
MOB HOPPER FILT SST		-	✓	✓	✓	-	-	✓	✓	64350160134115

## Maintenance kits

Description	Part number
Air motor seals kit	146.371.040
C160 Servicing kit (does not include seals)	144.050.160
C160 Seal kit - All purpose - #03 - UHMWPE+PTFE	144.050.413
C160 Seal kit - Abrasive - #04 - UHMWPE+Leather	144.050.414
C160 Seal kit - Warm - #05 - UHMWPE+PTFE G	144.050.415

## Accessories

Description	Part number
Suction rod 1"1/4 L=600 mm	149.597.200
Suction rod 2" L=600 mm	149.597.210
Suction rod 1"1/4 L=1000 mm	149.597.250
Priming kit (without filter) for 3/8" hoses	151.590.012
SST Equipped filter	155.581.456
Heavy duty trolley	151.590.700
Gravity hopper 20L	125.010.000
Magma heater range (refer to <b>page 66</b> for P/N detail)	156.160.0XX
Kit 1 sprayer : SFlow™ 470 with Tip Top 18-13 (519) - 1.6M + 1.6M hoses + fittings	151.590. 016
14 Seals PTFE G	144.050.426
14 Seals PTFE	144.050.425
14 Seals Leather	144.050.424
14 Seals UHMWPE	144.050.423

## 80C220

This paint pump is designed for rugged industrial applications & can feed two guns. It is recommended for long hose lengths.

- Perfect for high solids materials
- Built with minimal parts
- Lowest cost of ownership



## Configuration of the 80C220 Airless paint pump

Set-up	Suction rod (Ø25)	Drain rod	Air regulator Fluid pressure	Pump output filter	Part number
Cart-mounted	✓	-	✓	✓	151.245.980

## Maintenance kits

Description	Part number
Leather/PE seal kit	106.284
Air motor seal kit	146.340.090
Silencer kit	146.320.091
Distributor kit	146.320.092
Distributor seal kit	146.320.093

## Accessories

Description	Part number
Suction rod 1"	921.270.101
Stainless steel flushing rod F18x125	049.596.000
Cart	208690
Fluid filter	155.582.050
Adaptor Stainless steel F 3/4" JIC/M 1/2" JIC	905.160.219

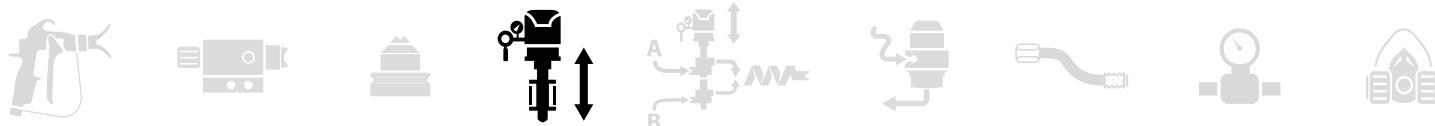

## Flowmax® pumps

➤ The exclusive Flowmax® SuperLife Technology is available only with **SAMES KREMLIN**. Nothing of similar pressure and fluid output in the piston pump design outperforms the Flowmax® SuperLife technology. Flowmax® pumps substantially outlast standard piston pumps using self-adjusting seals. In addition there is no lubricant cup, thus eliminating packings. In sum, this is a packing-free pump that performs quietly with minimal service. Nothing Compares !

➤ The Bellows eliminates the top packings and lubricant cups found on other double acting pumps. Virtually pulsation free with low friction seals giving a smooth motion.

The Flowmax® bellow technology keeps the air and the light out which is crucial when processing:

- Moisture sensitive Polyurethane hardener
- Waterbased paint
- UV curing paints

This pumps are also excellent for material recirculation applications with low pulsation characteristics

 Flowmax® Bellow Technology is a patented **SAMES KREMLIN** design that ensures balanced fluid delivery and long leak free operation.

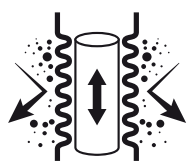

Flowmax® technology



**With this technology, no need to care if the lubricant cup is enough filled out with lubricant ! You can use it with eyes closed.**

### Selection table

FEATURES	BENEFITS	34F60	40F50	40F100	40F260	65F260
Sealing ensured by a Superlife™ bellow seal	High reliability					
	no more lubricant cups					
	leak free					
	Total sealing between pump and its environment, ideal to work with moisture sensitive catalysts	✓	✓	✓	✓	✓
	ideal for uV and pre-catalyzed materials					
Large and smooth fluid passages	fluid discharge without retention of a wide range of coating materials	✓	✓	✓	✓	✓
Stainless steel design	Compatible with water-based materials	✓	✓	✓	✓	✓
Balanced fluid section	Constant fluid output pressure	✓	✓	✓	✓	✓
mobile piston seal	Excellent suction capacity	✓	✓	✓	✓	✓
External valves assembly	Easy maintenance	✓	-	-	-	-
floating piston	Fast inversions and very high efficiency	✓	-	-	-	-
Sprayed material	Waterbased	✓	✓	✓	✓	✓
	Solvent base	✓	✓	✓	✓	✓
	Primers	✓	✓	✓	✓	✓
	Stains				-	
	Direct Gloss / Metallic				-	
	Top coats / High Gloss	✓	✓	✓	✓	✓
	UV products	✓	✓	✓	✓	✓
	Moisture sensitive	✓	✓	✓	✓	✓
	Two components					
	Anti-corrosion / abrasives					
	Adhesives					
	Sealants					
	Greases					
Wax						



# Selection table of Flowmax® pumps

Pump name	34F60	40F50	40F100	40F260	65F260
<b>Construction</b>					
Stainless Steel	✓	✓	✓	✓	✓
Bellow					
Upper sealing					
Lower sealing	GT	GT	GT	GT	GT
Turbo version	-	-	-	-	-
Stainless Steel ball	✓	✓	✓	✓	✓
316L ball		✓*	✓*		
<b>Assembling</b>					
Bare	-	✓	✓	-	-
Wall mounted	✓	✓	✓	✓	✓
Cart mounted	✓	✓	✓	✓	✓
Portable	-	-	-	-	-
<b>Dimension (wall mounted pump without filter or suction rod)</b>					
Height (mm)	610	975	975	1120	1160
Width (mm)	410	400	400	300	485
Depth (mm)	250	280	280	510	575
Weight (kg)	26,5	37	42	110	120
<b>Characteristics</b>					
Pressure ratio	34/1	40/1	40/1	40/1	60/1
Output per cycle (cc)	60	50	100	260	260
Number of cycle (per liter)	17	20	10	3,846153846	3,846153846
Output at 30 cycles/min (L)	1,8	1,5	3	7,8	7,8
Free flowrate (L/min)	3,6	3	6	15,6	15,6
Max fluid pressure (bar)	204	240	240	240	390
Max Paint temperature (°C)	50	50	50	60	60
Operating air pressure (bar)	1-6	1-6	1-6	1-6	1-6
Air consumption at 30 cyc/min and 4 bar (m(3)/h)	22,03	21,60	43,20	112,32	182,52
<b>Fittings</b>					
Air inlet	F 3/4 BSP				
Fluid Inlet	M 26 x 125			M 38 x 150	
Fluid Outlet (bare)	F 3/8 NPS			F 3/4 NPS	
Fluid Outlet (after filter)	M 1/2 JIC			M 3/4 JIC	

✓ available

✓\* optional

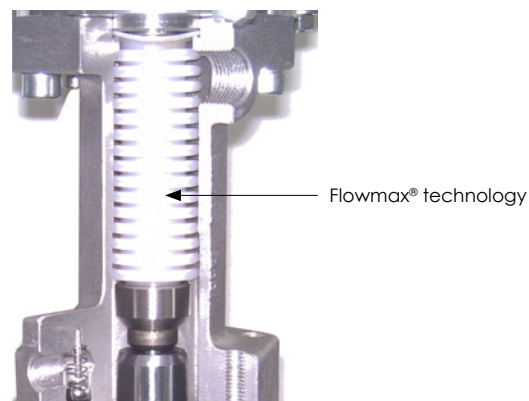

# 34F60



The Flowmax® paint pump uses Flowmax® technology for total sealing, performance and extended lifetime for Airless® applications.

- **Unique Flowmax® Bellows technology**
- **Extended lifetime**
- **Easy maintenance**

LUB FREE PUMP ENSURES TOTAL SEALING AND RELIABILITY



## Configuration of the 34F60 Flowmax® paint pump

Set-up	Suction rod (Ø25)	Drain rod	Air regulator Fluid pressure	Pump output filter	Part number
Wall-mounted	✓	✓	✓	✓	151.740.700
1 arm cart	✓	✓	✓	✓	151.740.750

## Maintenance kits

Description	Part number
Seal kit for 2000-2 air motor	144.929.902
Repair kit for 2000-2 air motor	144.929.912
Seal kit for F60 fluid section	144.910.799
Repair kit for F60 fluid section	144.910.797
Seal kit for external valves	144.910.798

## Accessories

Description	Part number
Two Post Cart w/o plate	051.221.000
Two Post Pump Mounting Plate	056.100.199
Easyflow suction rod Ø25 plunging tube length 600 mm	149.596.150
Easyflow suction rod Ø25 plunging tube length 1000mm (for 200 liters drums)	149.596.160
Stainless steel flushing rod F18 x 125	049.596.000
1 arm cart	051.730.110
Fluid filter	155.580.400
Gravity hopper 6 liters	151.140.250

# 40F50



This Flowmax® pump is recommended for feeding 2 guns.

- Flowmax® technology for zero maintenance
- Designed for moisture-sensitive and abrasive materials
- Extended lifetime

LUB FREE PUMP ENSURES TOTAL SEALING AND RELIABILITY



## Configuration of the 40F50 Flowmax® paint pump

Set-up	Suction rod (Ø25)	Drain rod	Air regulator Fluid pressure	Pump output filter	Part number
Bare pump	-	-	-	-	151.776.000
Wall Mounted without filter	✓	-	✓	-	151.776.100
Wall mounted	✓	✓	✓	✓	151.776.200
2 arm cart-mounted	✓	✓	✓	✓	151.776.400

## Maintenance kits

Description	Part number
Seal kit for 1000-4 air motor	146.270.991
Repair kit for 1000-4 air motor	146.270.995
Seal kit for F50 hydraulic section	144.950.291
Repair kit F50 hydraulic section	144.950.292

## Accessories

Description	Part number
Two Post Cart w/o plate	051.221.000
Two Post Pump Mounting Plate	056.100.199
Easyflow suction rod Ø25 plunging tube length 600 mm	149.596.150
Easyflow suction rod Ø25 plunging tube length 1000mm (for 200 liters drums)	149.596.160
Stainless steel flushing rod F18 x 125	049.596.000
1 arm cart	051.730.110
Fluid filter	155.580.400
Gravity hopper 6 liters	151.140.250

# 40F100



This Flowmax® pump is recommended for feeding 2 guns.

- Flowmax® technology for zero maintenance
- Designed for moisture-sensitive and abrasive materials
- Extended lifetime

LUB FREE PUMP ENSURES TOTAL SEALING AND RELIABILITY



## Configuration of the 40F100 Flowmax® paint pump

Set-up	Suction rod (Ø25)	Drain rod	Air regulator Fluid pressure	Pump output filter	Part number
Bare pump	-	-	-	-	151.786.000
Wall mounted	✓	-	✓	-	151.786.100
Wall mounted	✓	✓	✓	✓	151.786.200
2 arm cart-mounted	✓	✓	✓	✓	151.786.400

## Maintenance kits

Description	Part number
Seal kit for 2000-4 air motor	146.270.990
Repair kit for 2000-4 air motor	146.270.996
Seal kit for F100 hydraulic section	144.960.291
Repair kit F100 hydraulic section	144.960.292

## Accessories

Description	Part number
Two Post Cart w/o plate	051.221.000
Two Post Pump Mounting Plate	056.100.199
Easyflow suction rod Ø25 plunging tube length 600 mm	149.596.150
Easyflow suction rod Ø25 plunging tube length 1000mm (for 200 liters drums)	149.596.160
Stainless steel flushing rod F18 x 125	049.596.000
1 arm cart	051.730.110
Fluid filter	155.580.400
Gravity hopper 6 liters	151.140.250

## 40F260



This Flowmax® pump is recommended for anti-corrosion applications.

- Flowmax® Bellows technology for zero maintenance
- Designed for moisture-sensitive & abrasive materials
- Extended lifetime

HIGH OUTPUT, CARTRIDGE FREE BELLOW PUMP FOR CIRCULATING AND AUTOMATIC MACHINES



## Configuration of the 40F260 Flowmax® paint pump

Set-up	Upper sealing	Lower sealing	Suction rod (Ø25)	Drain rod	Air regulator Fluid pressure	Pump output filter	Part number
Wall mounted	GT	GT	-	-	✓	-	151.871.500
Wall mounted	GT	GT	✓	-	✓	✓	151.871.600
Wall mounted	GT	GT	-	-	✓	✓	151.871.800
Wall mounted	PU	PU	-	-	✓	✓	151.871.660
Cart-mounted	GT	GT	✓	-	✓	✓	151.871.700

## Maintenance kits

Description	Part number
Seal kit for 5000-4 air motor	146.280.991
Repair kit for 5000-4 air motor	146.280.996
GT Seal kit for F460 hydraulic section	144.020.690
PU Seal kit for F460 hydraulic section	144.020.691
GT Repair kit F460 hydraulic section	144.020.695
PU Repair kit F460 hydraulic section	144.020.692

## Accessories

Description	Part number
Two Reinforced Arms w/o mounting plate	051.231.000
Pump bracket	051.341.206
Suction rod Ø25 plunging tube length 600 mm	049.597.100
Stainless steel flushing rod F18 x 125	049.596.000
Fluid filter	155.581.400

# 65F260



This Flowmax® pump is recommended for anti-corrosion applications.

- Flowmax® Bellows technology for zero maintenance
- Designed for moisture-sensitive & abrasive materials
- Extended lifetime

HIGH OUTPUT, CARTRIDGE FREE BELLOW PUMP FOR CIRCULATING AND AUTOMATIC MACHINES



### Configuration of the 65F260 Flowmax® paint pump

Set-up	Suction rod (Ø25)	Drain rod	Air regulator Fluid pressure	Pump output filter	Part number
Wall mounted	✓	-	✓	✓	151.881.600
Cart-mounted	✓	-	✓	✓	151.881.700

### Maintenance kits

Description	Part number
Seal kit for 8000-4 air motor	146.280.991
Repair kit for 8000-4 air motor	146.280.996
GT Seal kit for F460 hydraulic section	144.020.690
PU Seal kit for F460 hydraulic section	144.020.691
GT Repair kit F460 hydraulic section	144.020.695
PU Repair kit F460 hydraulic section	144.020.692

### Accessories

Description	Part number
Two Reinforced Arms w/o mounting plate	051.231.000
Pump bracket	051.341.206
Suction rod Ø25 plunging tube length 600 mm	049.597.100
Stainless steel flushing rod F18 x 125	049.596.000
Fluid filter	155.581.400



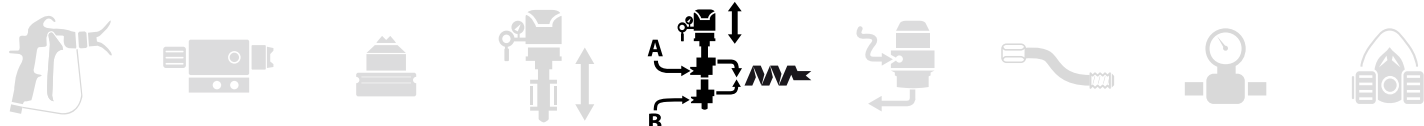

# Mechatronic & Electronic dosing

**SAMES KREMLIN** offers a complete range of 2K liquid systems for material dosing. Their uses are either mechatronic or electronic dosing machine .  
Our systems integrate many technologies, here are the main ones:

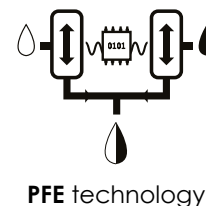





Injectmix technology allows injecting a custom catalyst volume into a continuous flow of base - directly in a high performance mixer, thus guaranteeing the mixing quality. The two materials are then instantly vehicles in an inline static mixer without intermediate pre-mixing chamber.

Pulse-Free Electronic Control (PFE) acts on unique pump changeover technology to ensure consistent metering. Liquid mixing technology PFE technology exist on the reverse pump in hidden time to ensure consistent metering.

- EASY to flush technology: limiting maintenance
- HIGH ACCURATE mixing
- DIFFERENT INJECTOR size: optimal hardener injection volume

- PRECISE METERING because the pumps never change over during an injection cycle.
- PULSATION FREE You will never have a spray pattern variation during spraying
- DOSING ACCURACY of  $\pm 1\%$

Specifications	 	 			
Machine name	PU3000	Cyclomix™ Micro	Cyclomix™ Multi	Cyclomix™ II & Expert	
Dosing type	Mechatronic	Electronical			
Ratio	Adjustable				
Injectmix technology	✓	-			
PFE technology	✓	✓			
<b>Dimension</b>					
Height (cm)	28.6 (control cabinet) - 130-150 (dosing unit)	17.3 (control cabinet) - 40 (dosing unit)	60 (control cabinet) - 77 (mixing unit)	60 (control cabinet) - 91 (mixing unit 2K)	
Width (cm)	36.7 (control cabinet) - 86 (dosing unit)	36.6 (control cabinet) - 40.7 (dosing unit)	60 (control cabinet) - 60 (mixing unit)	60 (control cabinet) - 89 (mixing unit 2K)	
Depth (cm)	14.3 (control cabinet) - 70 (dosing unit)	11.1 (control cabinet) - 30 (dosing unit)	40 (control cabinet) - 77 (mixing unit)	40 (control cabinet) - 68 (mixing unit 2K)	
Weight (kg)	-	25	70	48 (2K)	
<b>Characteristics</b>					
Electrical Power	115 / 230V - 75W	115 / 230V - 75W	115 / 230 V - 75 W	115 / 230V - 75W	
Trigger air pressure (bar mini)	6	4	4	4	
Product pressure (bar)	2 - 320	2 - 175	2 - 200	5 - 200	
Wetted parts	Stainless steel and PeHD	Stainless steel and PEHD 316L stainless steel on PH version catalyst side	Stainless steel and PeHD	Stainless steel and PeHD (option 316L)	
Mixing ratio	1/1 to 20/1	single component and 0.6/1 to 20/1	0.6/1 to 20/1 (160% to 5%)	0.6/ at 30/1	
Mixing accuracy	+/- 1%	+/- 1%	+/- 1%	+/- 1%	
Number of Products	1	1 - 3	7* - 20*	21*	
Mixed fluid output (cc/min)	PU 3000 2I: up to 2000 PU 3000 4I: up to 4000	100 - 2000	100 - 2000	50 - 6000	
Fluid viscosity	30 - 8000 cps	30 - 5000 cps	30 - 5000 cps	30 - 5000 cps	
<b>Fittings</b>	Air inlet	F 3/4" BSP	-	F 1/4" BSP	-
	Air outlet	F 1/4" BSP	-	F 1/4" BSP	-
	Fluid Inlet	-	M 1/2" JIC	M 1/2" JIC	-
	Fluid Outlet	F 3/4" JIC	M 1/2" JIC	F 1/4" BSP	-

\* This value is interdependent on the number of catalysts



Electronic mixing and dosing paint pump

# PU 3000 AIRLESS®

Electronic dosing & mixing equipment, includes pumping, metering & electronic functions in low and medium pressure.  
Available in 2 versions: 2 Liters and 4 Liters.

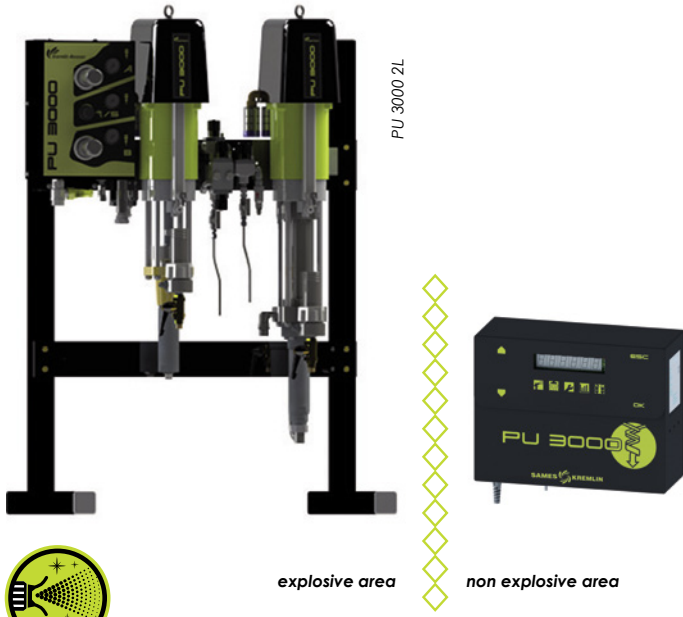

- User friendly
- Material mixing quality
- Security of application



**PLUG AND SPRAY SOLUTION PUMPING AND MIXING 2 COMPONENTS WITH ADJUSTABLE RATIO**



FEATURES	BENEFITS
Plug & Spray	Quick start-up
<b>SAMES KREMLIN</b> patent : Free Pulse Electronic Control (FPE) Innovative control system of pump change-over	Constant fluid flowrate Unsurpassed +/- 1% mixing accuracy and +/- 1% repeatability
Direct injection in the high performance static mixer	Perfect mixing
Recording of fluid consumptions and VOC Possibility to print records	Fluid and solvent consumptions stored in memory
Automatic component management : base, catalyst and solvent Automatic flushing and material generation User-friendly control panel	User-friendly and easy programming for the operator
Preventive maintenance alarm Continuous ratio checking and alarm Low level drum alarm	Safe operation
Ratio check kit in standard with 2 liters test tube Filter and drain assembly in standard	Visual control of mixing accuracy No product loss
Sealing done by a FLOWMAX® bellow on the catalyst side	High reliability Ideal to work with moisture-sensitive catalysts
Variable ratio from 5 to 160%	Suitable for use on a wide range of markets

### Configuration of the PU 3000 AIRLESS® dosing paint pump

Description	Fluid volume per cycle (cm3)	Pressure Ratio	Hardener section	Part number
PU3000 2L AIRLESS	124	53/1	C-Cup or Cup lub	155.680.102
PU3000 4L AIRLESS	227		C-Cup or Cup lub	155.680.150
PU3000 4L AIRLESS (Flowmax)	260	40/1	Flowmax®	155.680.175

### Option

Description	Part number
Spray booth glass mounting kit	155.660.340

### Flushing pump

Description	Suction rod	Purge rod	Air regulator fluid pressure	Part number
30-C25 flushing pump - PU 3000	• (Ø 16)	-	-	151.145.090

### Seal kit

Description	Seal mix	Part number
Seal kit for AIRLESS 2L	PE/PTFEG	107-282
Seal kit for AIRLESS 4L		107-366

Electronic mixing and dosing paint pump

# CYCLOMIX™ Micro

The Plural Component Electronic Mixing & Dosing System allows the user to dose, mix & continuously deliver two-component paints or adhesives.



- Fresh material on demand
- Elimination of manual mixing errors
- Significant material savings

ENTRY LEVEL DOSING MACHINE UP TO 3 COLORS MANAGEMENT



Supplied without pumps or guns to be ordered separately  
Designed to supply one gun only



FEATURES	BENEFITS
Automatic component management : base, catalyst and solvent	Dosing +/- 1% and repeatability +/- 0.5%
Automatic flushing and material generation	Quick start-up. Minimal material and solvent wastage.
Adjustable flushing volume Several flushing sequence available : only Base side; Base side then Catalyst ; Catalyst side then Base side	Solvent savings and environmental protection
Continuous ratio checking and alarm	The paint applied on parts always conforms to specifications
User-friendly control panel	User-friendly and easy programming for the operator
Stainless steel design	To handle a wide range of materials
Recording of fluid consumptions and VOC with the possibility to print records (with RS 232 option)	Fluid and solvent consumptions stored in memory
Possibility to monitor the Cyclomix™ Micro from the spray booth (with the glass kit option)	Ergonomy of the working station
Design of the mixing plate	Easy maintenance and spare parts standardization
PH version (stainless steel 316L)	Compatible with acid catalyst

## Configuration of the CYCLOMIX™ Micro electronic dosing system

Description	Catalyst flushing	Number of bases	Number of catalysts	Part number
CYCLOMIX™ Micro	-	1	1	155.660.900
	-	3		155.660.930
CYCLOMIX™ Micro+	•	1		155.660.911
	•	3		155.660.933
CYCLOMIX™ Micro+ PH (without mixer - see options)	•	1		155.660.951
	•	3		155.660.953

## Options

Description	Part number
Mixing assembly for Cyclomix® Micro+ PH	155.660.955
RS 232 connection kit for printer	155.660.935
Spray booth glass mounting kit	155.660.340
5m extension cable between control cabinet and mixing panel	901.250.216

Electronic mixing and dosing paint pump

# CYCLOMIX™ Multi

The Cyclomix™ Multi allows the user to dose, mix & continuously deliver two-component paints or adhesives.

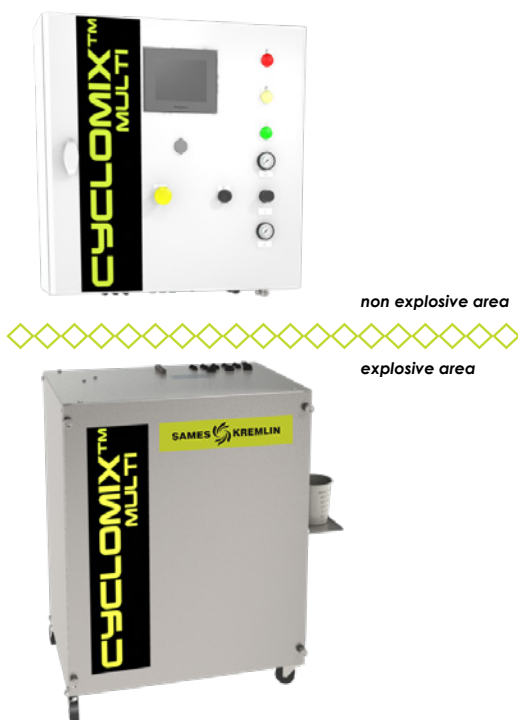

non explosive area

explosive area

- Elimination of manual mixing errors
- Material savings guaranteed
- Always fresh material on demand

PROFESSIONAL DOSING MACHINE UP TO 20 COLORS



Supplied without pumps or guns to be ordered separately  
Designed to supply one gun only



FEATURES	BENEFITS
Automatic component management: base, catalyst and solvent	Dosing +/- 1% and repeatability +/- 0.5%
Automatic mix material fill	Quick start-up. Minimal material and solvent wastage.
Adaptable programming for each color	Ideal application for each color
Several flushing modes: production cycle, extended production stops, solvent-based materials	Perfect compatibility with production conditions evolutions
Fast mixing ratio accuracy	Visual control of mixing accuracy
batch mode	To easily get small quantities of mixed materials for touch-up works
Autowash system	Off-production gun automatic monitoring
Multilingual display and integrated instruction manual	User-friendly and easy programming for the operator
Stainless steel design	Compatible with water-based materials
Numerical interface	Quick link with an on-line automate
Integrated spraying air management	Comfort and safety during color and solvent fill
Pneumatic emergency flushing	Perfect flushing in case of power supply cut-off
Design of the mixing plate	Easy maintenance and spare parts standardization
Robotic interface	Connection with an on-line automate

## Configuration of the CYCLOMIX™ Multi electronic dosing system

Description	Number of bases	Number of catalysts	Part number
CYCLOMIX™ Multi	3	1	155.660.813
	5		155.660.815
	7		155.660.817
	3	2	155.660.823
	5		155.660.825
	3		155.660.833
CYCLOMIX™ Multi Configurable	up to 20	up to 10	Contact us
CYCLOMIX™ Multi PH (without mixer - see options)	3	1	155.660.513
	5		155.660.515
	7		155.660.517

## Option

Description	Part number
Autowash	155.660.300
Static mixer 1 m long.	155.660.955

Electronic mixing and dosing paint pump

# CYCLOMIX™ II & Expert

The Cyclomix™ II & Expert are an innovative, industrial solution that are configured to meet the needs of the customer.



non explosive area



explosive area



Supplied without pumps or guns to be ordered separately

- Capable of metering 1 component as well as mixing 2 and 3 component materials
- Flexible modular design - up to 24 programmable components
- PH version available for acid-catalyzed coatings
- Handles up to 50 recipes
- Constant flow technology

PREMIUM DOSING MACHINE UP TO 3 COMPONENTS



FEATURES	BENEFITS
Automatic component management up to 24 components in 1, 2, 3 components and solvent	Innumerable possibilities Flexibility when changing materials
Real time display of instant real ratio and flowrate	Continuous process control
No pre-mixing chamber: optimized fluid passages w/o retention zones	Perfect flushing Prevent fluid waste
Stainless steel design	Compatible with water-based materials
Frequency configuration before flushing at the end of potlife	Mixed material and solvent savings Safe operation
Emergency pneumatic manual flushing	Perfect flushing in case of power supply cut-off
Batch mode	To easily get small quantities of mixed materials for touch-up works
Adaptable programming for each color	Ideal application for each color
3 data access level upon each operator	Safety use
Assisted data and tolerance product manufacturer specification entry	Quick and easy data entry eliminating any errors
Color man/machine interface	User friendly
Standard monitoring of 2 guns (2 priming - 2 flushing)	Possibility to manage 2 workstations simultaneously (1 or 2 guns or both)
Ratio check	Safe operation Full operator safety
6 different flushing sequences (air-solvent es standard) Volume or time flushing Multiples solvent choice for each recipe	Solvent consumption optimization upon recipe Optimized flushing
Magnetic injection volume adjustment - electro magnetic valves	Mixing optimization upon ratios Increase of injection frequency
USB data storage Batch number management	Production Follow-up optimization
Various Product mesurement technology: mass or gear	Handles a large range of materials

## Configuration of the CYCLOMIX™ II & Expert electronic dosing system

Description	Part number
CYCLOMIX™ II & Expert	Contact us



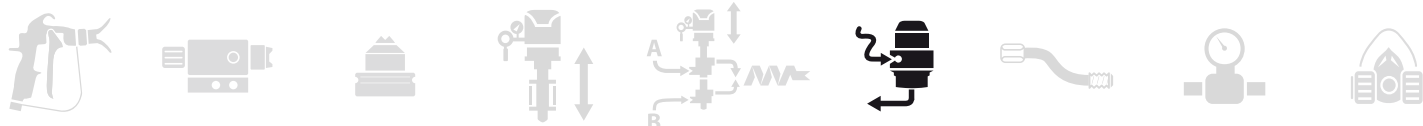

# Fluid regulators

## Regulation technology

The driven regulator technology consists in flow controlled by an air pressure regulator. The air pressure is applied on all the regulator diaphragms where a manual spring pushes on a limited surface. The high performance diaphragm delivers very high precision even at low pressures. It also brings fast response time to robotic applications.

**REMOTE control**

**FAST response**

**HIGH precision**

Fluid pressure regulators are used to reduce and balance the fluid pressure delivered from a pump. Regulators are designed to deliver constant fluid pressure based upon the inputs or setting of the regulator. Fluid regulators should be placed as close as possible to the point of application.

The fluid regulator closes and stops fluid flow when the downstream pressure in the hose of the regulator is greater than the set regulator pressure.

The input fluid pressure should be approximately 40% higher than the regulated pressure. For good control in a pneumatic regulated system, a stable air supply is required. Fluid supply pulsation should be minimized to help ensure ideal regulator function.

Specifications		Pressure regulator			Regsmart range	Regmaster range
		Manual control	Piloted	Piloted - back pressure	Piloted	
Pressure range	Inlet	400	400	230	See dedicated page	See dedicated page
	Outlet (upon version)	20 - 150	20 - 230	20 - 230		
Width (cm)		9,5	14,8	14,8		
Height (cm)		23,5	16	16		
Fittings	Air inlet	-	F 1/4" BSP	F 1/4" BSP		
	Fluid Inlet	F 3/8" BSP	F 3/8" BSP	F 3/8" BSP		
	Fluid Outlet	F 3/8" BSP	F 3/8" BSP	F 3/8" BSP		

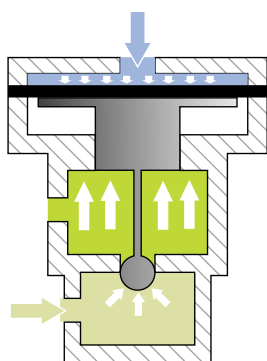

### FLUID FLOW

Force equilibrium unbalanced: the air piston doesn't move; the piston ball check "Inlet Material" is closed by the fluid pressure.

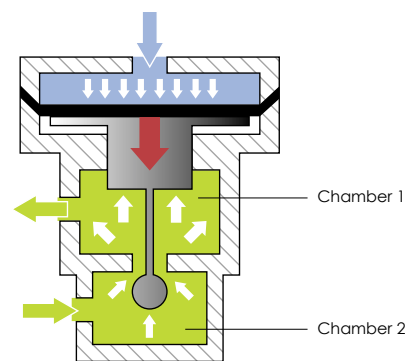

### PRESSURE DROP

As soon as a pressure drop occurs in the system the regulator piston moves with air pressure by opening the ball check and allowing material to flow in chamber 2.

# Fluid regulators

## Pressure regulator manual & piloted control

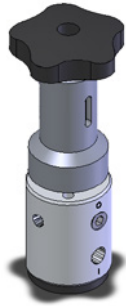

#1

### Pressure regulator manual & piloted control

	Description	Inlet pressure	Regulated pressure	Part Number
#1	Manual	400B	20/150B	1027900111
#2	Piloted	400B	25-230B	1027850111
#3	Back pressure piloted	230B	25-230B	103360

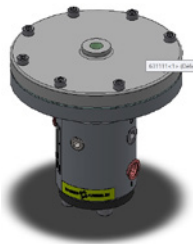

#2 & 3

### Seal kits

	Description	Part Number
#1	Mix of FFKM seals	102,887
#2 & 3	Mix of FFKM seals + diaphragm	107,196
#3	Mix of Viton, EPDM and PTFE seals + diaphragm	107,361



### High pressure gauges

Metal pressure gauge with glass and glycerin lens ; totally impact and solvent resistant.

Description	Pressure range (bar)	Fitting	Internal diameter (mm)	Part number
Diaphragm high pressure gauge (Y mounted)	0 - 250	M 3/8" NPS F 3/8" NPS	50	155.271.790
Pressure gauge side inlet	0 - 120	M 1/4 G	63	910.010.802
	0 - 400			910.010.801

Spray guns

Pumps

Machines & Controllers

Accessories

General informations

# REGSMART Regulators

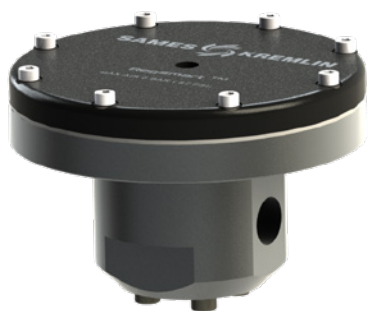

A regulator is needed when you want to control fluid pressure/flow rate, change fluid pressure to different values in a short time, dampen out pulsation on pump, change over and help prevent "snake head" effect on gun opening.

Specially designed for medium viscosity materials, RegSMART diaphragm design is ideal for moisture-sensitive and water-based materials. The modular design enables you to control over a wide range of flowrates.

RegSMART regulators incorporates a cartridge design, reducing dead zones, ensuring minimum downtimes during maintenance.



## Technical data

	REGSMART REGULATOR	REGSMART STAINLESS STEEL
Inlet pressure (bar Max)	400	
Outlet pressure range (min/max bar)	25 / 275	
Air pressure (bar max)	6	
Air inlet thread	1/4" F BSPP	
Weight (Lbs)	4.2 kg (9.25)	6.2 kg (13.66)
Max working temperature (°C)	80	
Material Inlet & outlet	3/4" F BSPP	
Wetted parts	Aluminum, PTFE, FFKM	Stainless steel, PTFE, FFKM
Average output (l/mn)*	diameter 6 - 0.9 l/mn diameter 8 - 3 l/mn diameter 12 - 9 l/mn	

\* measured at free flowrate with product viscosity of 15.000 cPs.

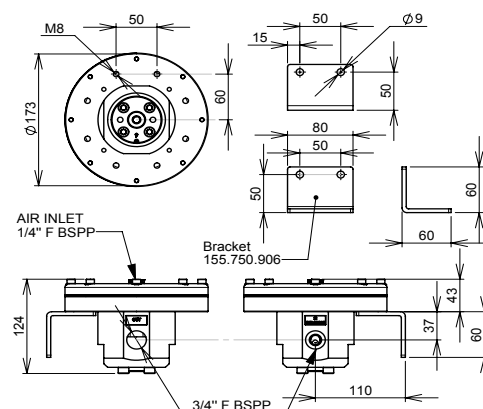

## REGSMART Part number

Designation	Material	Part Number
REGSMART - 275 bar - ball 6 (cold application)	Aluminum	155.750.000
REGSMART - 275 bar - ball 8 (cold application)	Aluminum	155.750.100
REGSMART - 275 bar - ball 12 (cold application)	Aluminum	155.750.200
REGSMART - 275 bar - ball 6 (cold application)	Stainless steel	155.751.000
REGSMART - 275 bar - ball 8 (cold application)	Stainless steel	155.751.100
REGSMART - 275 bar - ball 12 (cold application)	Stainless steel	155.751.200

## Accessories

Designation	Description	Part number
Regsmart support	Bracket and fixing screws	155750906
Air regulator kit	Air regulator with assembly accessories and pressure gauge - 0.3 to 7 bar	155750908

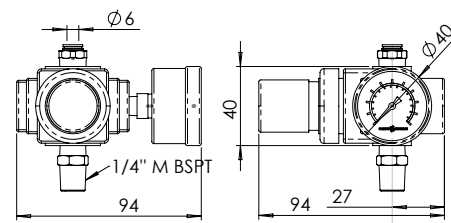



# REGSMART Regulators

A regulator is needed when you want to control fluid pressure/flow rate, change fluid pressure to different values in a short time, dampen out pulsation on pump, change over and help prevent "snake head" effect on gun opening.

The modular design enables you to control over a wide range of pressures. Our regulators are well known for their high precision and repeatability especially in automated applications.

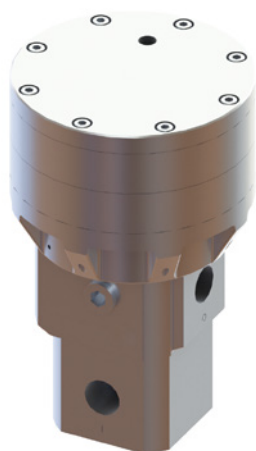

## Technical data

	REGMASTER 40	REGMASTER 80	REGMASTER 120	REGMASTER 160	REGMASTER 200
Number of plates	1	2	3	4	5
Inlet pressure (bar Max)	400	400	400	400	400
Outlet pressure range (min/max bar)	5 / 40	7 / 80	12 / 120	15 / 160	20 / 200
Air pressure (bar max)	6	6	6	6	6
Air inlet thread	1/4" F BSPP	1/4" F BSPP	1/4" F BSPP	1/4" F BSPP	1/4" F BSPP
Material inlet & outlet	3/4" F BSPP	3/4" F BSPP	3/4" F BSPP	3/4" F BSPP	3/4" F BSPP
Max working temperature (°C)	80	80	80	80	80
Wetted parts	Aluminum	Aluminum	Aluminum	Aluminum	Aluminum/stainless steel on request
Height (mm)	184	212	240	263	296
Diameter (mm)	150	150	150	150	150
Weight (Lbs)	6 kg (13,22)	6,5 kg (14,33)	7 kg (15,43)	7,5 kg (16,53)	8 kg (17,63)

## REGSMART Part number

The diffusor allows to reduce the needle wear

Designation	Option	Part Number
REGMASTER (cold application) - 200 b 5 PLT	with diffusor	1061250251
REGMASTER (cold application) - 400/40 b 1 PLT	-	1061250111
REGMASTER (cold application) - 400/80 b 2 PLT	-	1061250121
REGMASTER (cold application) - 400/120 b 3 PLT	-	1061250131
REGMASTER (cold application) - 400/160 b 4 PLT	-	1061250141
REGMASTER (cold application) - 400/200 b 5 PLT	-	1061250151
REGMASTER (cold application) - 400/40 b 1 PLT	with diffusor	1061250211
REGMASTER (cold application) - 400/80 b 2 PLT	with diffusor	1061250221
REGMASTER (cold application) - 400/120 b 3 PLT	with diffusor	1061250231
REGMASTER (cold application) - 400/160 b 4 PLT	with diffusor	1061250241

Spray guns

Pumps

Machines & Controllers

Accessories

General informations

# Heater

## Magma 500



WARM UP PRODUCTIVITY

Material fluid heater is an auxiliary device used for material preparation and air heating. Higher layer thicknesses can be achieved by heating the material, as well as shorter drying times and higher finishing quality.

- **High pressure for heavy duty applications**
- **Excellent performances even without Fluid recirculation**
- **Stainless steel design and Explosion proof, compatible with most coatings**



FEATURES	BENEFITS
Standard Stainless steel design	Compatible with water-based materials
Thermometer integrated into the command box	Direct information on the desire temperature
Flexible positioning of the heat exchanger connections	Easy implementation
The highest fluid passage volume of the market	Insure outstanding performances even when used as one pass (without recirculation)
Possibility of heating atomizing air	Increase finishing quality and regrease drying times
ATEX Compliant	Can be used in hazardous atmosphere
Weather resistant	Always efficient even in high humidity environments

### Specifications

Heater name	MAGMA 500 ID9			MAGMA 500 ID14			
Maximum fluid pressure	500 bar (7 250 psi)						
Fluid passage volume	0.225 L (0.0594 gal)			0.390 L (0.130 gal)			
Internal diameter	9 mm (0.35")			14 mm (0.55")			
Fluid passage length	354 cm (140")			253 cm (100")			
Voltage range (V)	115	230	400	115	230	400	440 (1)
Maximum fluid temperature	90 °C (194 °F)						
Temperature classification	T4						
Wetted parts	Stainless Steel						
Weight	17,6 kg (38.8 lbs)						
Explosion Proof	II 2G Ex db IIB T4 Gb						
Dimensions (H x L x l)	405 x 220 x 180 mm (16 x 8.7 x 7.1 in)						

(1): Need an external control unit with a switching element for 440V

# Magma 500

## Configuration of the MAGMA 500 material fluid heater

Description	Fitting IN/OUT	Internal Fluid diameter (mm)	Volt max (V)	Power (W)	Material	Pmax pressure (bar)	Delta T°C	Phase	Part number		
ID14 HV 230V 3500W M3/4 JIC	M 3/4 JIC	1,4	230	3500	SST	500	15-90	1	156.160.010		
ID14 HV 115V 1800W M3/4 JIC			115	1800			15-90	1	156.160.020		
ID 14 HV 400V 3800W M3/4 JIC			400	3800			15-90	3	156.160.030		
ID9 230V 3500W M1/2 JIC	M 1/2 JIC	0,9	230	3500			15-90	1	156.160.040		
ID9 115V 1800W M1/2 JIC			115	1800			15-90	1	156.160.050		
ID9 400V 3800W M1/2 JIC			400	3800			15-90	3	156.160.060		
ID14 HV 440V 3500W M3/4 JIC	M 3/4 JIC	1,4	440	3500					15-90	1	156.160.070

## Accessories

Description	Fits to ID	Part number
TEMPERATURE INDICATOR FOR MAGMA 500 ID9	9 mm (0.35")	156.160.110
TEMPERATURE INDICATOR FOR MAGMA 500 ID14 HV	14 mm (0.55")	156.160.111
KIT FOR HEATING ATOMIZING AIR MAGMA 500	9 mm (0.35") & 14 mm (0.55")	156.160.114

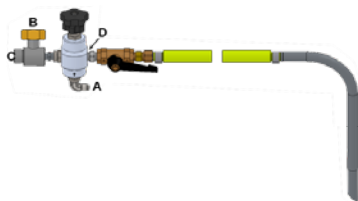

### Fluid line - Circulation valve

A circulation valve allows paint recirculation at the pump bottom (piston pump) and permits to set the perfect output for material circulation.  
Max. fluid pressure = 240 bar

## Configuration of Circulation valve

Version	Material	A. Inlet fitting	Outlet fitting		D. Purge	Flushing valve	Flushing rod M 18x125	Part Number
			B. Pump intake	C. Suction rod				
Bare	SST	F 1/4 NPS	F 1/4 BSP	-	F 1/8 BSP	-	-	149.220.420
Circulation kits	Carbon steel	M 1/2 JIC	F 26x125	M 26x125	-	✓	✓	051.314.010
		M 3/4 JIC	M 1" G	M 38x150				051.341.100
	SST	M 1/2 JIC	F 26x125	M 26x125				051.314.050
		M 3/4 JIC	M 1" G	M 38x150				051.341.100

## Maintenance

Description	Part number
Maintenance kit for recirculation valve	049.220.450

# Fluid line

## CTM Color Change Valves

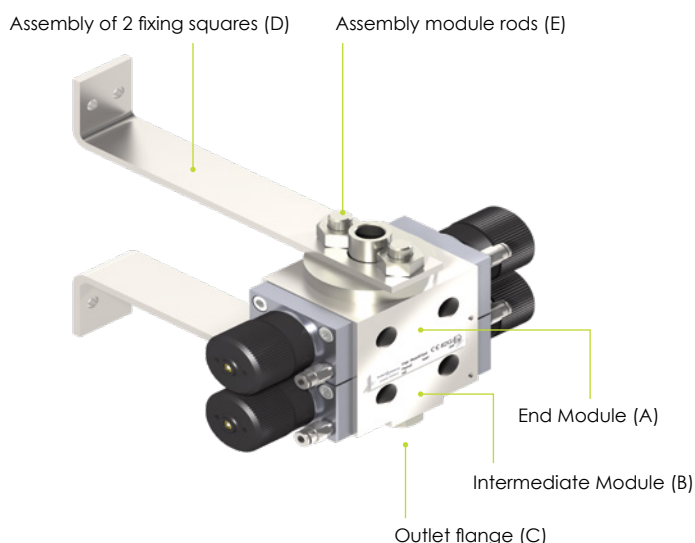

- CTM are designed for a rapid color change.
- No dead zone inside CTM reducing flushing time and solvent consumption
  - PTFE seals
  - Design allows modular expansion
  - Monostable valve normally closed
  - Visual Opening detector
  - Two valves per module (the solvent valve should be facing the fluid outlet)

How to build your complete assembly upon the number of colors:

Nb of material up to	Number of element to order				
	(A) End module	(B) Intermediate modules	(C) Outlet flange	(D) Fixing square kits	(E) Rod assembly size
2	1	-	1	1	for 1 module
4		1			for 2 modules
6		2			for 3 modules
8		3			for 4 modules
10		4			for 5 modules

### CTM valve specifications

Description	CTM
Max pressure (bar)	120-200
Ø of passage (mm)	6
Trigger air	for hose 2.7 x 4
Fluid inlet	F 1/4 NPS
Fluid outlet	F 1/4 NPS

### Configuration of CTM Valves

Description	Max. pressure (bar)	Part number
Modules	End module (inlet)	120 155.535.300
	End module (inlet) - stainless steel (316 L)	200 155.536.200
	Intermediate module	120 155.535.400
	Intermediate module - stainless steel (316 L)	200 155.536.320
	Outlet flange	155.535.500
	Outlet flange - stainless steel (316 L)	155.535.410
	Fixing square kit	155.535.700
Description	Nb. of materials	Part number
Rod assembly size	For 1 module (1 end + 1 flange)	2 155.535.610
	For 2 modules (1 end + 1 intermediate + 1 flange)	4 155.535.620
	For 3 modules (1 end + 2 intermediate + 1 flange)	6 155.535.630
	For 4 modules (1 end + 3 intermediate + 1 flange)	8 155.535.640
	For 5 modules (1 end + 4 intermediate + 1 flange)	10 155.535.650

# Filters

## Bare fluid filters



Description	Maximum fluid pressure (bar)	Average output	Fittings			Part number
			Inlet	Outlet	Purge	
3/8" stainless steel filter - high pressure	360	4	1x F 3/8" NPT	2x F 3/8" NPT	1x F 1/4" NPT base	155.580.200
3/4" stainless steel filter - high pressure	360	6	1x F 3/4" NPS	1x F 3/4" NPS	1x F 3/8" NPS	155.581.450
1" double screen stainless steel - high pressure	480	9	1x F 1" NPS	1x F 1" NPS	1x F 3/8" NPS	155.582.000

## Accessories for filters

Description	Part number
Stainless steel filter fitting length 70 mm (MM 3/8" NPT)	055.580.301
Wall-mounted bracket and screws for 3/8", 3/4" and 1" filter with 9 digits part numbers	155.190.105

## Equipped filters

Equipped with inlet/outlet fittings and drain valve

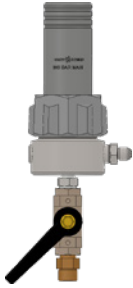

Description	Maximum fluid pressure (bar)	Screen	Fittings			Part number
			Inlet	Outlet	Purge	
Stainless steel accu 3/8" filter - medium pressure	240	6	F 3/8" NPT	M 1/2" JIC	M 18x125	155.580.300
Stainless steel accu 3/8" filter - medium pressure	250		F 1/2" JIC			155.580.600
Stainless steel accu 3/8" filter - medium pressure	240	12	F 3/8" NPT			155.580.400
Stainless steel accu 3/4" filter - High pressure	360	12	M 3/4" BSP	M 3/4" JIC	M 18x125	155.581.400
Stainless steel accu 3/4" filter - High pressure	360	12	F 1/2" JIC	M 1/2" JIC	M 18x125	155581410
Stainless steel filter 1" - High pressure double screen	480	15 (x2)	F 1" G	F 1" G	F 3/8" G	155.582.050
Stainless steel accu 3/4" filter - High pressure	500	15	M 3/4" BSP	1st = M3/8 NPSM 2nd = plug (F 3/4" BSP)	M 18x125	155.581.456

## Priming kit

A priming kit is used for easy pump priming or flushing when you are not using an equipped filter on the outlet of the pump



Designation	Max fluid pressure (bar)	Inlet	Outlet	Drain rod	Part Number
1/2 JIC priming kit	400B	F 1/2 JIC	M 1/2 JIC	-	155580700
3/4 JIC priming kit	400B	F 3/4 JIC	M 3/4 JIC	-	155581700
Azur priming kit	500B	M 3/4"	M 3/8 NPSM	-	151590012

## Screens for product filter



Filter number	Filtration size		Nozzle size	Quantity	Part number
	Micron	Mesh			
1	40	325	3	1	000.161.101
2	74	200			000.161.102
3	90	170			000.161.103
4	100	140			000.161.104
			4	25	100.161.104
6	168	85		6	1
			09 to 14	25	100.161.106
8	210	70		1	1
			20	25	100.161.108
12	280	55		1	1
			30 to 45	25	100.161.112
15	360	45		1	1
20	510	30	=<68	1	000.161.020
30	750	20			000.161.030

## Inline fluid filters 200 bar



Description	Maximum fluid pressure (bar)	Screen	Output (l/mn)	Fittings		Part number
				Inlet	Outlet	
Medium pressure stainless steel filter	200	6	2	F 1/4 NPS	F 1/4 NPS	055.600.000
Airmix filter MM 1/2 JIC	200	6	2	M 1/2" JIC	M 1/2" JIC	155.010.000
Airmix filter MF 1/2 JIC	200	6	2	M 1/2" JIC	F 1/2" JIC	155.010.100

## Screen for inline fluid filter

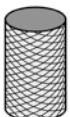

Stainless steel screen for filter	Size (µ)	Quantity	Part number
N° 4	100	5	129.609.907
N° 6	168	5	129.609.908
N° 12	280	5	129.609.909

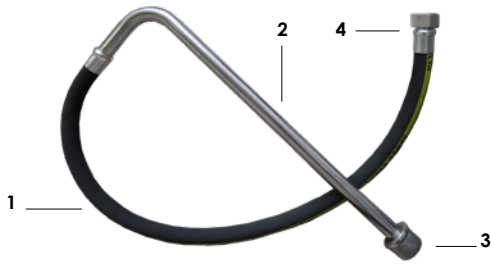

# Suction and flushing rod

A suction rod will transfer the paint from the drum to the pump inlet

Please refer to your pump information to know which suction rod will fit

NOTA : A suction rod will include a strainer and a flushing rod not

## Configuration for suction and flushing rod

Hose (1)				Tube (2)			Strainer (3)		Part Number	Shape	Suction rod	Flushing rod
ID	Length (mm/")	Material	Thread (4)	ID (mm/")	Height (mm/")	Material	Material					
1/4"	800 (31.5)	PEBD	F 18 x 125	6 (0.24)	280 (11)	SST	SST	051.665.620	Straight tube	✓		
	820 (32)				230 (9)			151.665.640	Straight tube			
3/8"	1000 (39)	PEBD	F 26x125		440 (17)			440 (17)	149.596.080			Elbow tube
					290 (11.4)			290 (11.4)	149.596.040			Straight tube without hose
3/8"	1000 (39)	PEBD	F 18 x 125	16 (0.63)	570 (22)	SST	-	049.596.000	Elbow tube	✓		
							-	049.596.200	Elbow tube + Elbow fitting			
							Polyamide	049.596.210	Elbow tube + Elbow fitting			
							Polyamide	049.596.020	Elbow tube			
							SST	149.596.050	Elbow tube			
							-	149.596.250	Straight hose without tube			
3/4"	1500 (59)	PEBD	F 18 x 125	-	-	-	-	149.596.250	Straight hose without tube	✓		
	1000 (39)			25 (1)	570 (22)	149.596.150	Elbow tube					
	1500 (59)				1000 (39)	149.596.160	Elbow tube					
1"1/10	1000 (39)	PEBD	F 26x125	25 (1)	570 (22)	SST	SST	149.597.100	Elbow tube	✓		
								921.270.101	Elbow tube			
								149.597.200	Elbow tube + Elbow fitting			
								149.597.250	Elbow tube + Elbow fitting			
1"1/10	1500 (59)	PEBD	F 1"1/4	28 (1.1)	600 (23.6)	SST	SST	149.597.200	Elbow tube + Elbow fitting	✓		
					1000 (39)			1000 (39)	149.597.250			Elbow tube + Elbow fitting

(1): Elbow fitting

## Strainer for suction rods



Pump	Height (mm)	External diameter (mm)	Material	filtration size		Part number
				Micron	MESH	
10C18	60	40	Polyamide	300	50	051.531.600
10C18	34	28	Stainless steel	1000	15	151.665.645
15C25 & 30C25 (ø16)	32,5	28	Stainless steel	1000	15	149.596.052
30C25, 15C50, 10C50, 17F60, 20C50, 20F50, 34F60, 40C50, 40F50, 08C240, 08F240, 16C240, 16F240 (ø25)	40	48	Stainless steel	1000	15	149.596.152
40C260, 40F260, 65C260, 65F260, 20.25 (OLD GENERATION)	112	66	Polyamide	1000	15	149.591.400
Azur™ 52C225 & 72C160	45	60	Stainless steel	2000	10	149.596.153

## Product hoses for suction rods

Polyethylene hose sleeve	Part number		
	ø9.5 mm	ø19 mm	ø25 mm
5 m cut	-	050.366.051	050.367.001
15 m cut	-	050.366.052	-
25 m cut	050.361.001	050.366.053	050.367.003
Grooved conical fittings	<b>050.140.517</b>	<b>050.140.545</b>	<b>050.140.543</b>
Nickeled nut fitting	050.271.303 (1)	050.271.502 (2)	049.595.306 (3)
1 wing collar	906.311.234	906.311.207	906.311.204

(1): F18x125, (2): F26x125, (3): F38x150

## Gravity hopper



Compatible with	Capacity	Thread	Par number
#1 15C25, 15C50, 30C25, 35C50, 40C50 & 40C100	6L	F 26 x 125	151.140.230
#2 34F60, 40F50, 40F100			151.140.250
#3 Azur™ 52C225 & 72C160	20L	F 1" 1/2	125.010.000

# Cyclix™ agitators

This elevator-agitator for 20-40 to 200 L drums features a double-effect jack for a fast lift of a stainless steel cover fitted for a quick material drum change. The cover is equipped with a motorized agitator fitted with blades for low viscosity materials and a full stainless steel rod.

The elevator is coming on a large fixing plate which makes it very stable and easy to install in paint kitchens, existing installations or an essential component of new installations.

- Constant quality of mixed materials
- Stainless steel wetted parts
- High ROI - no product loss



FEATURES	BENEFITS
Stainless steel (agitator cover, suction and drain rods)	Compatibility with all materials
Adjustable suction rod height	No product loss
Suction and return tubes	Suitable for recirculating
Double effect jack with 3 positions command lever: up, stop, down	Important flexibility
The agitator cannot work during elevator movements	Security

## Specifications

Agitator name	Cyclix™ 20-40	Cyclix™ 200
Capacity (L)	20 - 40	200
Motor type	Pneumatic	Pneumatic
Reductor type	-	Gear train
Rotation speed (rpm)	60 - 300	5 - 90
Motor torque (Nm)	2.2	34

Spray guns

Pumps

Machines & Controllers

Accessories

General informations

# Cyclix™ agitators

## Configuration of CYCLIX™ for 20 - 40 l drums

Description	Elevator height (mm)	Agitator rod length (mm)	Paddle diameter (mm)	Cover diameter (mm)	Part number
Elevator for 20 -40 l drums	1024 (min) - 1500 (max)	-	-	-	151.081.000
Agitator for 20 -40 l drums	-	400	134	-	154.261.700
Cover for 20 -40 l drums	-	-	-	400	154.261.600
Suction/exhaust kit	-	-	-	-	154.261.800

## Configuration of CYCLIX™ for 200 l drums

Description	Elevator height (mm)	Agitator rod length (mm)	Paddle diameter (mm)	Cover diameter (mm)	Part number
Elevator for 200 l drums	1510 (mini) - 2410 (maxi)	-	-	-	151.091.000
Agitator for 200 l drums	-	800	370	-	154.261.300
Cover for 200 l drums	-	-	-	635	154.261.200
Suction/exhaust kit	-	-	-	-	154.261.400

## Recommended accessories

Description	Part number
1/4" air lubricator + support	154.261.997
Exhaust assembly with oil recovery (length 1 m)	154.261.996
Air feeding kit	154.261.930
Drum roller unit for 200 litres drum	151.098.100
Slotted paddle for thick materials	154.261.952
HP 150 2 liters lubricant can	149.990.017

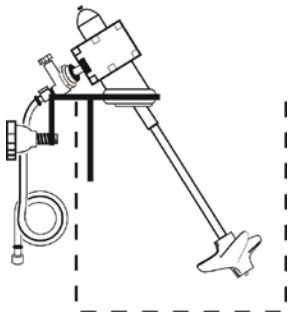

### Agitators for edge pail mounting

Agitator for barrel edge mounting.  
Minimum barrell height of 300 mm.

Description	Part number
Bare agitator	051.332.610
Agitator with 25 cm hose	051.332.600
Agitator with 5 m hose	049.220.710
System for barrel mounting	049.220.720



### Agitators on stainless steel cover

Agitator:  
For drums diameter between 295 and 325 mm.  
Minimum drum height of 390 mm.

Description	Part number
Agitator for Ø325 cover	903.290.101

### Strainer for Cyclix™ suction rods

Description	Part number
Strainer for cyclix™ suction rods	154.261.940



# Fluid Hoses



Those hoses should be chosen according to the maximum pressure delivered by your pump, the length and the diameter used in the application.

## Polyamide Fluid hoses configuration with JIC fittings

Configuration with JIC fittings - Part Number according to length with fittings per meter. Those hose insure constant conductivity between the spraygun and the pump and are compatible with most coatings.

Item	Part Number										
Conductive	YES										
Color	GREEN				BLACK						
Hose design	Single Braided				Double Braided		Single Braided		Double Braided		
Internal diameter mm	3.2 (1/8")	4.8 (3/16")	6.35 (1/4")	4.8 (3/16")	6.35 (1/4")		9.52 (3/8")	12.7 (1/2")	9.52 (3/8")	12.7 (1/2")	
Max. operating pressure (bar (psil))	240 (3 480.9)			325 (4 713.7)	300 (4 351.1)	450 (6 527)	500 (7 252)	225 (3 263.3)	175 (2 538)	425 (6 164)	375 (5 439)
Temperature	up to 100°C										
A and B fittings (free nut)	1/2 JIC						3/4 JIC	7/8 JIC	3/4 JIC	7/8 JIC	
Fitting material	Treated Steel									Treated Steel	
	Without Spring	With spring	Without spring								
0.4 m (1.3 ft)	-	-	050.450.101	-	-	-	-	-	-	-	-
0.5 m (1.6 ft)	-	-	-	-	76.022	-	-	76.035	-	76.074	-
0.6 m (1.9 ft)	-	-	050.450.106	-	-	-	-	-	-	-	-
0.8 m (2.6 ft)	-	-	050.450.107	-	-	-	-	-	-	-	-
1 m (3.3 ft)	-	050.450.601	050.450.102	76.010	76.023	050.451.001	-	76.036	76.049	050.450.905	-
2 m (6.5 ft)	-	050.450.602	050.450.109	76.012	76.025	-	76.064	76.038	76.051	76.077	76.090
3 m (9.8 ft)	-	050.450.603	050.450.110	-	76.026	-	76.065	76.039	-	050.450.904	76.091
4m (13.1 ft)	-	-	-	-	-	-	-	-	-	76079	-
5 m (16.4 ft)	-	050.450.604	050.450.108	-	76.028	050.451.002	76.067	76.041	-	76.080	76.093
6 m (19.6 ft)	-	-	-	76.016	76.029	-	-	76.042	-	76081	76.094
7 m (23 ft)	-	-	-	-	76.030	-	-	76.043	76.056	-	-
7.5 m (24.6 ft)	-	050.450.605	050.450.111	-	-	-	-	-	-	-	-
8 m (26.2 ft)	-	-	-	-	76.031	-	76.070	76.044	76.057	-	76.096
10 m (32.8 ft)	-	050.450.606	050.450.104	-	76.033	050.451.003	-	76.046	-	76.085	-
12 m (39.4 ft)	-	-	-	-	76.034	-	76.073	-	-	76086	-
14 m (45.9 ft)	-	-	-	-	-	-	-	-	-	76.842	-
15 m (49.2 ft)	-	050.450.607	050.450.112	-	-	-	-	-	-	-	-
18 m (59 ft)	-	-	-	-	-	-	-	-	-	76844	-
20 m (65.6 ft)	-	050.450.608	050.450.105	-	-	-	-	-	-	050.450.901	-
25 m (82 ft)	-	-	050.450.113	-	-	-	-	-	-	-	-
30 m (98.4 ft)	-	050.450.609	-	-	-	-	-	-	-	050.450.906	-
Stainless steel fittings											
0.6 m (1.9 ft)	-	050.450.651	-	-	-	-	-	-	-	-	-
1 m (3.3 ft)	050.451.151	-	-	-	-	-	-	-	-	-	-
1.6 m (5.2 ft)	050.451.155	050.450.654	050.450.155	-	-	050.450.951	-	-	-	-	-
3.4 m (11.1 ft)	-	-	-	-	-	-	-	-	-	-	-
5 m (16.4 ft)	050.451.152	050.450.652	050.450.152	-	-	-	-	-	-	-	-
6 m (19.6 ft)	-	-	-	-	-	-	-	-	-	-	-
7.5 m (24.6 ft)	050.451.153	050.450.653	050.450.153	-	-	-	-	-	-	-	-
10 m (32.8 ft)	050.451.154	-	050.450.154	-	-	-	-	-	-	-	-

Spray guns

Pumps

Machines & Controllers

Accessories

General informations

# Fluid Hoses

## PTFE Fluid hoses configuration with JIC fittings

Part Number according to length with fittings per meter.

PTFE hoses are highly recommended for moisture sensitive material (sensitive with air humidity) such as most hardener for Polyurethane paint and those which are chemically aggressive.

Item	Part Number									
Conductive	YES									
Color	Metallic grey									
Internal diameter (mm(inch))	4.8 (3/16")	6.35 (1/4")			9.52 (3/8")			12.7 (1/2")		19.5 (3/4")
Max. operating pressure (bar (psi))	290 (4 206)	240 (3 481)	500 (7 252)	150 (2 175)	345 (5 004)	500 (7252)	450 (6 527)	345 (5 004)	500 (7252)	
Temperature	up to 110°C									
A and B fittings (free nut)	1/2 JIC			3/4 JIC				7/8 JIC	1" 1/16 JIC	
0.6 m (1.9 ft)	052.452.010	-	-	-	-	-	-	-	-	
0.7 m (2.3 ft)	-	-	-	050.451.904	-	-	-	-	-	
1 m (3.3 ft)	-	052.452.001	050.457.301	050.451.903	-	-	-	-	-	
1.5 m (4.9)	-	-	050.457.302	-	-	-	-	-	-	
2 m (6.5 ft)	-	-	-	050.451.901	76.800	050.457.001	050.452.204	76.872	050.457.201	
3 m (9.8 ft)	-	-	-	-	76.801	-	-	76.874	-	
4 m (13.1 ft)	-	-	-	-	-	-	-	76.927	-	
5 m (16.4 ft)	-	052.452.002	-	050.451.902	76.802	050.457.002	-	76.928	050.457.202	
7 m (23 ft)	-	-	-	-	76.803	-	050.452.201	-	-	
10 m (32.8 ft)	-	-	-	-	76.914	-	050.452.203	-	050.457.203	

## POLYAMIDE Fluid hoses configuration with NPSM Stainless steel fittings

With NPSM fittings - Part Number according to length with fittings per meter

Max. operating pressure (bar (psi))	350 (5 076)			500 (7 250)		
Female nut	1/4 NPSM	3/8 NPSM	1/2 NPSM	1/4 NPSM	3/8 NPSM	1/2 NPSM
Ø internal (mm(inch))	Ø6.35 (1/4")	Ø 9.5 (3/8")	Ø12.7 (1/2")	Ø6.35 (1/4")	Ø 9.5 (3/8")	Ø12.7 (1/2")
0.5 m (1.6 ft)	050350101	050350201	050350301	050500101	050500201	050500301
1 m (3.3 ft)	050350102	050350202	050350302	050500102	050500202	050500302
1.6 m (5.2 ft)	050350103	050350203	050350303	050500103	050500203	050500303
3 m (9.8 ft)	050350104	050350204	050350304	050500104	050500204	050500304
7.5 m (24.6 ft)	050350105	050350205	050350305	050500105	050500205	050500305
10 m (32.8 ft)	050350106	050350206	050350306	050500106	050500206	050500306
15 m (49.2 ft)	050350107	050350207	050350307	050500107	050500207	050500307
30 m (98.4 ft)	050350108	050350208	050350308	050500108	050500208	050500308

## PTFE Fluid hoses configuration with NPSM Stainless steel fittings

With NPSM fittings - Part Number according to length with fittings per meter

Max. operating pressure (bar (psi))	350 (5 076)			500 (7 250)		
Female nut	1/4 NPSM	3/8 NPSM	1/2 NPSM	1/4 NPSM	3/8 NPSM	1/2 NPSM
Ø internal (mm(inch))	Ø6.35 (1/4")	Ø 9.5 (3/8")	Ø12.7 (1/2")	Ø6.35 (1/4")	Ø 9.5 (3/8")	Ø12.7 (1/2")
0.5 m (1.6 ft)	050350151	050350251	050350351	050500151	050500251	050500351
1 m (3.3 ft)	050350152	050350252	050350352	050500152	050500252	050500352
1.6 m (5.2 ft)	050350153	050350253	050350353	050500153	050500253	050500353
3 m (9.8 ft)	050350154	050350254	050350354	050500154	050500254	050500354
7.5 m (24.6 ft)	050350155	050350255	050350355	050500155	050500255	050500355
10 m (32.8 ft)	050350156	050350256	050350356	050500156	050500256	050500356
15 m (49.2 ft)	050350157	050350257	050350357	050500157	050500257	050500357
30 m (98.4 ft)	050350158	050350258	050350358	050500158	050500258	050500358

# Fittings

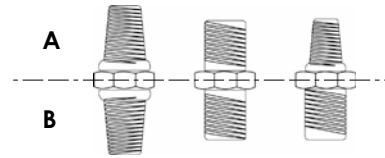

## Male to Male connection Pmax. = 20 Bar

Fittings and adaptor METRIC / NPT / BSP (Gas)

Male (A)	Male (B)								
	M 14 x 125	M 18 x 125	M 26 x 125	G1/4" (8x13)	G3/8" (12x17)	G1/2" (15x21)	G3/4" (20x27)	G" 1 1/4 (33x42)	G2" (50x60)
M 14 x 125		050.102.133 050.102.142(1)							
M 18 x 125	050.102.133 050.102.142(1)	050.102.102							
G1/8" (5x10)	050.102.412								
G1/4" (8x13)	050.102.405 050.102.441(1)	050.102.408 050.102.444(1)			904.523.003				
G3/8" (12x17)	050.102.410	050.102.411 050.102.436(1)		904.523.003		904.523.006			
G1/2" (15x21)	050.102.513	050.102.406 050.102.418(1)	050.102.402 050.102.437(1)		904.523.006		904.523.012		
G3/4" (20x27)		050.102.429	050.102.407			904.523.012	211017(1)* 905210710 (#)		
G" 1 1/4 (33x42)								144050052(1)	150104106(1)
1/2" NPT			050.102.507						

\* Length 850 mm, (1): Stainless steel, (#): Length 100 mm

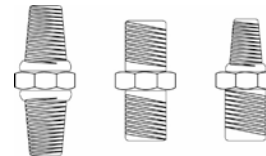

## Male to Male connection Pmax. = 60 Bar

Fittings and adaptor BSP (Gas) / NPS / NPT

Male (A)	Male (B)								
	G1/8" (5x10)	G1/4" (8x13)	G3/8" (12x17)	G1/2" (15x21)	G3/4" (20x27)	1/4" NPT	3/8" NPT	1/4" NPS	3/8" NPS
G1/8" (5x10)		906.314.207 (2)							
G1/4" (8x13)	906.314.207(2)	050.102.213 906.314.203 (2)	906.314.204 (2)	050.102.211 050.102.647(2)				050.102.624 050.102.644 (2)	050.102.646 (2)
G3/8" (12x17)		906.314.204 (2)	050.102.214 906.314.202 (2)	906.314.205 (2)				050.102.627 050.102.647 (2)	050.102.628 050.102.648 (2)
G1/2" (15x21)		050.102.211 050.102.647 (2)	906.314.205 (2)	050.102.212				050.102.633	050.102.629 050.102.649 (2)
G3/4" (20x27)					050.102.215				050.102.654 (2)
1/4" NPT							905.083.201		
3/8" NPT						905.083.201			
1/4" NPS		050.102.624 050.102.644 (2)	050.102.627 050.102.647 (2)	050.102.633				050.102.630	050.102.632
3/8" NPS		050.102.646 (2)	050.102.628 050.102.648 (2)	050.102.629 050.102.649 (2)	050.102.654 (2)			050.102.632	050.102.631 050.102.652 (2)

## Male to Female connection Pmax. = 20 Bar

Fittings and adaptor METRIC / NPS / JIC / BSP (Gas)

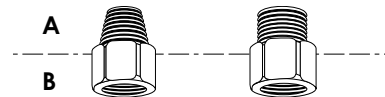

Male (A)	Male (B)								
	1/2" JIC	1/4" NPS	3/8" NPS	M 14 x 125	M 18 x 125	M 26 x 125	G1/4" (8x13)	G3/8" (12x17)	G3/4" (20x27)
1/2" JIC			050.103.537 (1)	050.230.619	050.230.620				
1/4" NPS			050.103.534 (1)	050.123.535	050.123.526				
3/8" NPS	050.123.533				050.123.610				
M 14 x 125			050.103.523 (1)		050.123.109				
M 18 x 125	050.123.521			050.123.101		050.123.110			
M 26 x 125					050.123.106				
G1/4" (8x13)								904.533.003	
G3/8" (12x17)							904.513.003		
G1/2" (15x21)							904.513.005		904.533.009
G3/4" (20x27)							904.513.011	904.513.012	
G1" (26x34)									904.513.012

# Fittings

## Male to Female connection

Fittings and adaptor NPS / JIC / BSP (Gas)



Male (A)	Female (B)		
	1/2" JIC	1/4" NPSM	G1/4" (8x13)
1/2" JIC		050.123.305 (XXXB???)	
1/4" NPSM	050.123.304 (XXXB???)		
G1/4" (8x13)			050.123.205 (60 BAR)

## Female to Female connection Pmax. = 60 Bar

Fittings and adaptor METRIC / BSP (Gas)

Female (A)	Female (B)		
	G1/4" (8x13)	G3/8" (12x17)	M 14 x 125
G1/4" (8x13)	904.593.002 552.486 050.470.301(1)	904.503.003	050.221.401



## T Female connection Pmax. = 25 Bar

Description	Part number
G1/4" (8x13)	904.303.002 550.038 (1)
G3/8" (12x17)	904.303.003
G1/2" (15x21)	904.303.004
G3/4" (20x27)	904.303.006
1/4" NPT	905.083.301 (2)



(1): Stainless steel 80 Bar; (2): 250 Bar

## T FMF CONNECTION

Female (A)	Male (B)	
	G1/4" (8x13)	G3/4" (20x27)
G1/4" (8x13)	552441 (20B)	-
G3/4" (20x27)	-	150104251 (500B) (1)

(1): Stainless steel

## Plugs Male Pmax. = 20 Bar

Description	Part number
G1/8" (5x10)	906.333.106
G1/4" (8x13)	906.333.102 906.314.211(1)
G3/8" (12x17)	906.333.104 906.314.216(1)
G1/2" (15x21)	906.333.103 906.314.210(1)
G3/4" (20x27)	906.333.105 906.331.116(1)
1/4" NPT	905.210.303(1)
3/8" NPT	905.210.304(1)



## Male to Male Fittings and Adaptors (Protective coated Steel) Pmax. = 360 Bar

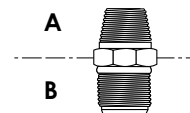

Male (A)	Male (B)					
	7/16" JIC	1/2" JIC	3/4" JIC	7/8" JIC	1 1/16" JIC	1 5/16" JIC
1/2" JIC	-	050.102.301	905.160.201	550.914*	-	-
3/4" JIC	-	905.160.201	905.160.202 550.545*	550.915*	-	-
7/8" JIC	-	550.914*	550.915*	-	-	-
1/4" NPT	-	000.972.025	905.160.212	-	-	-
3/8" NPT	-	000.972.028 050.470.202#	905.160.206 905.160.103#	-	-	-
1/2" NPT	-	-	905.160.204	-	-	-
3/4" NPT	-	-	905.160.203	-	-	-
G1/8" co	550.920*	550.548*	-	-	-	-
G1/4" co	-	550.542*	-	-	-	-
G3/8" co	-	550.549*	550.679*	550.609*	-	-
G1/2" co	-	-	550.544*	550.540*	550.903*	-
G3/4" co	-	550.905*	-	550.823*	550.864*	550.932*
G1" co	-	-	-	-	550.900*	550.901*

\* Up to 400 BAR, # Nickel Coated

# Fittings

## Male to Male Fittings and Adaptators (Stainless Steel) Pmax. = 250 Bar

Male (A)	Male (B)	
	1/2" JIC	3/4" JIC
1/2" JIC	905.210.709 (3)	906.314.217
3/4" JIC	906.314.217	-
1/8" NPT	905.210.501	-
1/4" NPT	905.210.502	905.210.512
3/8" NPT	905.210.503	905.210.513
1/2" NPT	905.210.504	905.210.514
3/4" NPT	-	905.210.515

(3): up to 400 Bar; (4): Nickel Coated

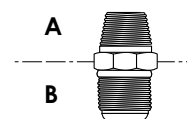

Spray guns

## Male to Male Fittings and Adaptators (Stainless Steel) Pmax. = 500 Bar

Male (A)	Male (B)		
	1/4" NPSM	3/8" NPSM	1/2" NPSM
1/4" NPSM	150104151	905210516	150104101
3/8" NPSM	905210516	150104152	-
1/2" NPSM	150104101	-	150104153
1/2" JIC	-	150104105	-
3/4" BSP	150104102	150104103	150104104

Pumps

## Male to Male Elbow Fittings and Adaptators (Protective coated steel) Pmax. = 400 Bar

Male (A)	Male (B)	
	1/2" JIC	3/4" JIC
1/8" NPT	905.160.105 (2)	-
1/4" NPT	-	905.160.102 (2)
3/8" NPT	-	905.160.103 (2)
1/2" NPT	-	905.160.104 (3)
G1/4" co	550.596	550.923
G3/8" co	551.819	-

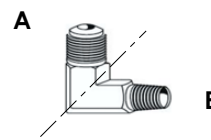

Machines & Controllers

## Male to Male Elbow Fittings and Adaptators (Stainless steel) Pmax. = 250 Bar

Male (A)	Male (B)	
	1/2" JIC	3/4" JIC
1/4" NPT	905.210.602	-
3/8" NPT	905.210.603	-
1/2" NPT	905.210.604	-
3/4" NPT	-	905.210.615

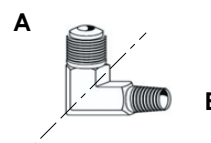

Accessories

## Male to Female Elbow Fittings (Stainless Steel) Pmax. = 360 Bar

Male (A)	Female (B)	
	1/2" JIC	
3/4" JIC	905.210.602	

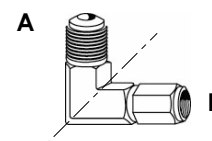

General informations

## Female to Female Elbow Fittings (Protective coated steel) Pmax. = 400 Bar

Female (A)	Female (B)	
	G 3/4"	G1"
G 3/4"	551011	-
G1"	-	551012

# Fittings

## T FEMALE CONNECTION Pmax = 250 BAR

Female (A)	Part number
1/4" NPT	905.083.301

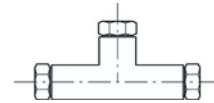

## Y Stainless steel fitting High Pressure

Female (A)	Male (B)
1/2" JIC	2 x 1/2" JIC 029.520.500



## Plugs Male Pmax. = 360 Bar

Description	Part number
1/8" NPT	905.083.301
1/4" NPT	905.210.303
G1"	551.247



## Plugs female Pmax. = 360 Bar

Description	Part number
1/2" JIC	906.333.301



## Check valve

Description	80 BAR	200 BAR	400 BAR	500 BAR
FF 1/4" NPT			903.160.512 (1)	
FF G3/4"				601.278 (L86 mm)
FF G1"			625.119 (L141 mm) 625.759 (2) (L141 mm)	
MF G3/8"		900.011.229		
MF G1/2"	104.403 (1)			

(1): Stainless steel; (2): with plug

## Swivel fittings

Description	Max pressure	Inlet	Outlet	Part number
TWIST SWIVEL FITTING	500	M 1/2" JIC	F 1/2" JIC	129.670.425
		M 1/4" NPSM	F 1/2" JIC	129.670.435

## Valves

Thread	Material	Pressure (bar)	Connection	Part number
1/4"	Brass	10	MF	90017
	Brass	16	FF	903090806
	SST	500	FF	601374
	Carbon steel	400	FF	601046
	SST	400	FF	903091101
3/8"	-	10	MF	903093302
	Brass	30	FF	903090206
	SST	500	FF	903090220
1/2"	Carbon steel	500	FF	601047
	SST	64	FF	903090219
3/4"	Carbon steel	400	FF	903090211
	Carbon steel	500	FF	601048
1"	Brass	20	FF	903090208
	Carbon steel	315	FF	903090212
1"	Carbon steel	315	FF	601074



## 3 way valves

Thread	Material	Pressure (bar)	Connection	Part number
1/4 NPT	SST	175	FFF	903090221
3/8"	Carbon steel	120	FFF	903091003
1/4"	SST	120	FFF	903091006



# Air line Air Hoses



Used in majority of the applications, allows the equipment (gun and pump) to have the same potential, ATEX certified.

- 60% lighter
- 150% more flexible

## Air hoses configuration

Available in 3 diameters:	Small	Medium	Big
<b>Technical Characteristics</b>			
Material	TPU*	TPU*	Nitrile
Color	Black	Black	Black
Internal Diameter (mm)	6.5	8	10
External Diameter (mm)	10.5	12	16
Conductor	Yes	Yes	Yes
Weight (grams per meter)	61	75	130
Max operating pressure in bar	14	14	10
Operating temperature in °C	-40 to 80	-40 to 80	up to 60
<b>Hoses with fittings</b>			
Fittings	1/4" NPS		3/8" NPS
0.6m	050.382.105	050.389.109	-
1.2m	050.382.102	050.389.107	-
2m	050.382.111	050.389.110	-
5m	050.382.109	050.389.101	050.381.101
7.5m	050.382.114	050.389.103	-
10m	050.382.110	050.389.102	050.381.102
12.5m	050.382.106	-	-
15m	050.382.116	050.389.105	-
20m	-	050.389.108	-
30m	-	050.389.106	-
<b>Hoses without fittings</b>			
25m	050.382.001	050.389.001	050.381.001
152m	050.382.006	050.389.005	-
<b>Fittings</b>			
Hose crimp ring	906.311.237	906.311.238	906.311.226
KIT STRAIGHT CONN. + NUT 1/4 NPS	050.231.705	050.231.707	050.231.702
<b>fitting = 1 crimp ring + 1 kit</b>			
Manual Crimper (Diameters 5 to 22)			906.311.202

\* TPU : Thermoplastic Polyurethane

## Polyamide or Polyurethane Air Hoses

Non-conductive hoses to clip on automatic guns or any other device.

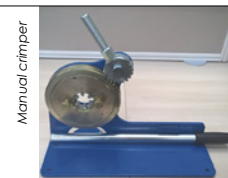

Conductive	No							
Max operating pressure	10 Bar							
Temperature	Up to 60°C							
Length	25m							
Material	Polyamide				Polyurethane			
<b>Color</b>	<b>Translucent</b>			<b>Black</b>		<b>Green</b>		<b>Black</b>
Diameter (internal/external) in mm	2.7 x 4	4x6	6x8	6x8	8x10	4x6	6x8	8x12
Part number	050.372.102	050.372.103	050.372.104	050.372.124	050.372.125	050.372.213	050.372.214	050.372.226

## Hose Sleeve

Hose sleeve adds a protection to the hose for a longer life

Product hole (mm)	Length (m)	Part number
40	10	129.270.087

# Fittings

## FAST FITTINGS FOR SMALL DIAMETER SPECIAL AIR HOSES

A	B	Straight	Right angle 90°	T- piece
G1/8" (5x10)	4	905.120.907	905.120.926	
	6	905.124.901	552262	
	8		905.120.934	
G1/4" (8x13)	4		905.120.927	
	6	905.120.965	905.120.905	
	8	905.120.904	905.120.912	905.120.920
	10	905.190.406	552280	
G3/8" (12x17)	10		905.190.415	

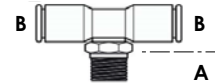
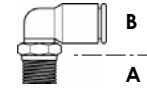
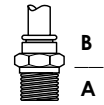

## Fast fitting T

Description	Part number
For hose 2,7 x 4	905.120.957
For hose 4 x 6	905.120.903
For hose 6 x 8	905.120.915
Reduction 2,7 x 4 / 4 x 6	905.120.928



## Fast fitting reduction and union

Description	to	Part number
Ø2,7 x 4	Ø4 x 6	905.120.945 (C)
Ø4 x 6		552.322 (D)
Ø6 x 8		905.120.923 (C)

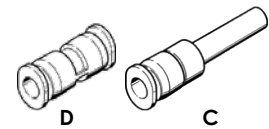

## Fast fitting reduction, union and plug

	Description	Part number
E	FAST PLUG 4X6	905120924
E	FAST PLUG 2.7X4	905120937
F	ELBOW FAST FITTING BULKHEAD 2.7X4	905120910
F	ELBOW FAST FITTING BULKHEAD 4X6	905120911
G	ELBOW FAST FITTING MF 2.7X4	905120983



## Y Air fitting

Description	to	Part number
F 1/4" NPS	2x M 1/4" NPS	129.029.920



## ISO 6150 Quick-fit fittings (maximum pressure: 10 bar)

Type	Complete assembly H and I	Part H	Part I			
			Female fitting	Male fitting	Cuanneled	
					Ø 7	Ø 10
Ø5 (14x125)	905.030.405	905.030.102	905.030.406	-	905.030.203	905.030.204
Ø5 (1/4" BSP)	-	-	-	905.030.804	-	-
Ø5 (1/4" BSP)	-	-	905.030.803	-	-	-
Ø5 (1/4" NPS)	905.030.105	905.030.104	905.030.106	-	-	-
Holding collar	-	-	-	-	906.311.224	906.311.226

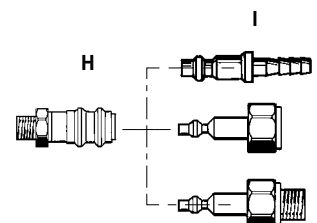



## Fittings

## Complete quick disconnect 1/4" NPS for air hose

Description	Part number
Air inlet quick-disconnect fitting	905.030.105

## Quick fittings for Ø 8 hose

Type	Part A with on/off press button for hose Ø 8	Part C for hose Ø 8
Ø 5	905.030.801	905.030.802

## Crimp fittings for low pressure air hoses

Description	Thread size	Hoses Inter. Diameter (mm)	P/N : J	P/N : K
<b>Straight fittings</b>				
Nickel plated brass	1/4" NPS	7	050.231.705	906.311.224
Nickel plated brass	1/4" NPS	8	050.231.707	906.311.224
Nickel plated brass	1/4" NPS	10	050.231.702	906.311.226
Nickel plated brass	3/8" NPS	7	050.231.716	906.311.224
Nickel plated brass	3/8" NPS	10	050.231.706	906.311.226
Nickel plated brass	3/8" NPS	16	050.231.701	906.311.232
Stainless steel	M 14 x 125	5	050.230.610	906.311.208
Nickel plated brass	M 14 x 125	10	050.230.602	906.311.226
Nickel plated brass	M 18 x 125	7	050.230.616	906.311.224
Stainless steel	M 18 x 125	10	050.230.614	906.311.226
Nickel plated brass	M 18 x 125	10	050.230.606	906.311.226
Nickel plated brass	M 18 x 125	16	050.230.601	906.311.232
Nickel plated brass	M 26 x 125	16	050.230.603	906.311.232
<b>Elbow fittings - L</b>				
Nickel plated brass	M 18 x 125	10	050.250.202	906.311.226
<b>Junction fittings without thread - M</b>				
Nickel plated brass	-	7	050.190.403	906.311.224
Nickel plated brass	-	10	050.190.401	906.311.226

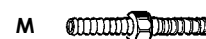
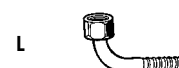

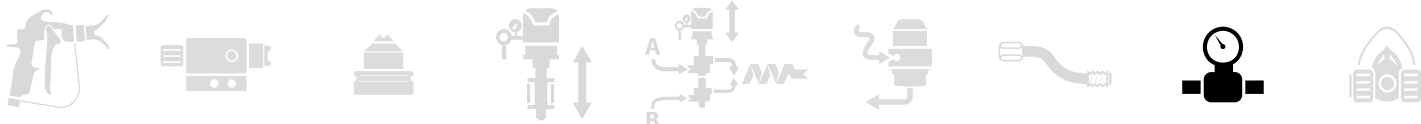

# Pressure regulators

## Air regulators



1/4" (with phosphor or black knob), 1/2" and 3/4" (with phosphor knob) regulators are used on the compressed air lines.

### Configuration of pressure regulator

Description	Inlet pressure (bar)	Regulated pressure (bar)	Max output (m3/h)	Inlet	Outlet	Part number	Wall mounting option				
Phosphore knob regulator	9	3,5	25	F 1/4"	F 1/4"	116.240.500	-				
Black knob regulator						116.380.700	016.180.010				
Phosphore knob regulator		5,5				116.370.700	016.180.010				
Black knob regulator						016.370.500	-				
Equipped regulator with isolating valve and pressure gauge		20				5,5	25	F 1/2"	F 1/2"	019.720.000	-
phosphore knob regulator						9	116.365.500			-	
Black knob regulator							116.360.500			-	
Black Bare regulator	21	4	360	F 3/4"	F 3/4"	016.200.000	-				
Black Bare regulator		9				016.280.000	-				
Equipped regulator with pressure gauge and wall bracket						019.780.100	-				
Red ring regulator		10				016.470.000	-				
Red ring regulator						016.480.000	-				
Black Bare regulator	7	91.530	210.006								

## DE37 Purifier-regulator



Usually fitted in the paint spray booths. Its twin-body construction ensures completely water and oil free.

#### Technical characteristics:

- Maximum operating air output: 37 m3/h
- Maximum operating air pressure: 10 bar
- Height: 290 mm
- Air inlet opening: F1/4"G

#### Standard equipment:

- One regulated pressure gauge
- One F1/4"G
- One tap valve F1/4"G
- Two air outlet taps: M 1/4" NPS

Specifications	DE37
Air output (m <sup>3</sup> /h)	37
Maximum fluid pressure (bar)	10
Height (cm)	29
Fitting	Air Inlet F8 x 13G
Set-up	1 regulated pressure gauge 1 valve F 1/4" G 1 ball valve F 1/4" G 2 air outlet taps M 1/4" NPS

Description	Part number
Purifier with DE 37 regulator	015.240.000
Blue cartridge for water	015.230.500
Red cartridge for oil	015.230.200

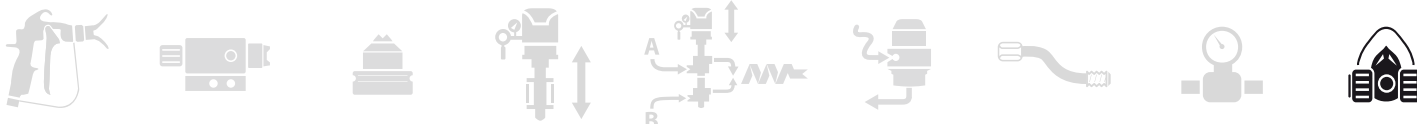

# Protection RC 756 respirators

Lightweight, comfortable respirators efficient for each type of paint and compliant with the latest european norms (Respirator: EN 140, Filters: EN 14393).

FEATURES	BENEFITS
Respirator body made of silicone	Hypoallergenic and high comfort
Equipped with large inlet and outlet valves	Easy breathing
Double fixing straps	Comfortable
Double filters	Performance (large diameter), visibility and high level of safety
Three high performance filters type available (solvented, water-based or multi with isocyanate materials)	For an optimal protection whatever the type of paint used

## Configuration of the RC756 respirator

Description	Part number
RC 756 respirator	143.380.100
RC 756 respirator for SOLVENT-BASED PAINTS - A1 filters	143.380.200
RC 756 respirator for WATER-BASED PAINTS - A1B1P3 filters	143.380.300
RC 756 respirator for PLURAL COMPONENT PAINTS - ISOCYANATES - A1B1E1K1P3 filters	143.380.400

## Filters and pre-filters

Description	Type	Quantity	Part number
Filters for solvented paints	A1	10	143.380.210
Filters for water-based paints	A1B1P3	5	143.380.310
Filters for plural-components-isocyanates	A1B1E1K1P3	5	143.380.410
Pre-filters for A1 filters	-	25	143.380.110

## Accessories

Description	Quantity	Part number
Attach strap	1	143.380.120
Spare inlet/outlet valves	3	143.380.130

Spray guns

Pumps

Machines & Controllers

Accessories

General informations

# Protective overalls



Protects the operator. Comfortable to wear, giving protection for dust or plush.  
Conforms to European Standards

- Made in non-woven fabric, they come with elasticated wrists and wide trouser legs to protect footwear

Description	Size	Quantity	Part number
Overalls Size S for 5 sets	S	5	564.504.001
Overalls Size M for 5 sets	M	5	564.504.002
Overalls Size L for 5 sets	L	5	564.504.003
Overalls Size XL for 5 sets	XL	5	564.504.004
Overalls Size XXL for 5 sets	XXL	5	564.504.005

# Protective hood

Protects the head and hair.

- Non-woven, light and lets the skin breathe
- Conforms to European Standards

Description	Quantity	Part number
Protective hood	5	043.250.001

# Miscellaneous Lubricants & greases

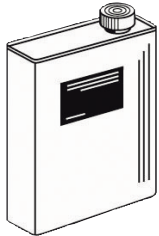

## Lubricants, greases and glue for pumps

Description	Volume	Material	Part number
<b>Lubricants</b>			
T lubricant can	125ml		149.990.020
T lubricant kit	3x 2L = 6L	For solvent-based paints	151.260.820
P lubricant can	2L		149.990.022
P lubricant kit	3x 2L = 6L	For Polyurethane paint	151.260.823
Oil HP 150 For diaphragm pump & oiler (for agitator)	2L		149.990.017
<b>Grease</b>			
Vaseline	1kg		560.440.002
Box of PTFE grease	450g		560.440.001
Box of grease special air motor seals (Isoflex)	1kg		560.440.005
Box of grease (Isoflex)	1kg		560.440.003
Grease tube special air motor seals	20g		560.440.105
Teflon® grease tube (Technilub)	10ml		560.440.101
Box of white grease	450g		560.420.005
<b>Glue</b>			
"Anaerobic adhesive waterproof for seals"	75 ml		554.180.001
"Anaerobic adhesive strong thread"	50 ml		554.180.004
Low strength anaerobic adhesive tube	50 cc		554.180.010
Retaining Compound - high strength. General purpose. Fast curing.	50 cc		554.180.014
Sealing glue tube	250ml		554.180.015

## Miscellaneous

Description	Part number
M22 / Fpro /Xcite™ gun wrench	049.030.042
Large size brush	906.300.101
Small size brush	906.300.102
Wrench for product filters	049.030.018
Large blow gun	129.371.000
Viscosity cup n° 4 CA4	049.221.400
Thickness gauge from 25 to 2000µ	000.790.020
Adhesive-roller with Sames Kremlin logo (75mm x 100m)	571.141.003
Teflon roll 13.5M.X12.7mm	554.600.301
Azur™ key	149.030.017
Key for ASC and ASB	149.030.043

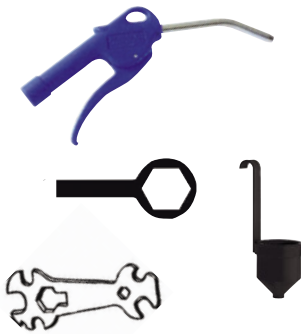

# Compatibility of trolleys

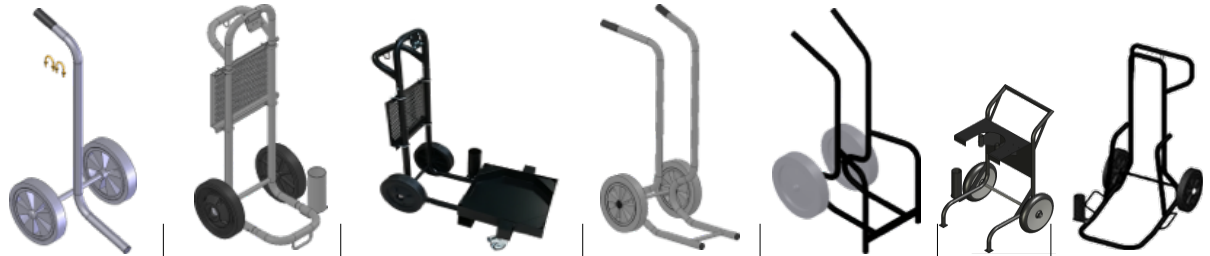

	Single post cart	Dismountable trolley	Dismountable trolley with drum table	Double post cart	Reinforced double post cart	Cart	Heavy Duty Trolley
<b>P/N</b>	<b>051.730.110</b>	<b>151.241.000</b>	<b>151.242.000</b>	<b>051.221.000</b>	<b>051.231.000</b>	<b>208.69</b>	<b>151.590.650</b>
10C18	✓						
15C25		✓	✓				
15C50		✓	✓				
30C25		✓	✓				
35C50		✓	✓				
40C50				✓			
40C50WB				✓			
40C100				✓			
40C100WB				✓			
40C260					✓		
Azur™ 52C225							✓
53C124						✓	
65C260					✓		
Azur™ 72C160							✓
80C220						✓	
34F60				✓			
40F50				✓			
40F100				✓			
40F260					✓		
65F260					✓		

Description	Part number
(1) Drum table alone	151.240.009



Description	Part number
Perforated rack with brackets	056.100.199





# General informations

## Paint

Decoration and protection are often two associated functions. To achieve these aims, and to re-finish products, we have at our disposal a tremendous number of surface treatments, (for example nickel or chrome plating etc).

Paint is also perfect for both of these functions. In addition, paint is universally used, and can be applied on any surface, such as wood, metal, stone, leather, plastic and elastomers. Paint does not come as a finished product, and hence the quality of application will depend on all its stages of preparation, which we will call the "Painting System".

In general, the stages are as follows :

- » Surface preparation
- » Application of the coating (paints, stains, varnishes, etc)
- » Drying

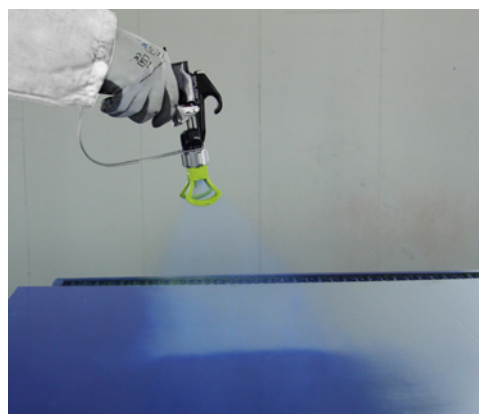



## Paint

## Surfaces preparation

There is a wide range of physical and chemical treatments to which the surface to be coated can be subjected, before receiving the first coat. Good surface preparation is the essential base for long-lasting protection and a good visual finish on any material.

The surface preparation is often the longest, and therefore the most important task involved in coating a part.

Material	Physical preparation	Chemical preparation
Steel:	stripping, shotblasting, brushing	acid
Aluminum:	Brushing	Vapor blast
Wood:	Sanding	
Plastic:	heating	plasma torch, acid

**Once treated, the surfaces should be free from :**

- » particulate or non-adherent substances
- » oil, grease and moisture

**To obtain the best protection against corrosion (mainly for metal), we coat with either :**

- » a wash primer or
- » an anti-corrosion paint

A **wash primer** is a liquid product of around 16s Zahn#2, which should be sprayed in a thin coat, to get into all the imperfections in the surface of the metal. The phosphoric acid which it contains attacks the surface of the metal and forms an isolating and impenetrable layer of phosphate. The wash primer is highly valued for its adhesion to the metal. Importantly, it should then be coated with a layer of paint, which plays the role of a protective shield.

An **anti-corrosion** paint is a product which should be sprayed in a thicker layer than the wash primers. Containing anti-corrosive elements, it has the advantage of protecting the metal both physically and chemically at the same time. Also, it saves time, as a single coat applies both the anti-corrosive chemicals and the protective shield to the metal.

These paints are used very frequently on metal framework, as the coating can be left as it is, or covered subsequently with the desired paint finish.

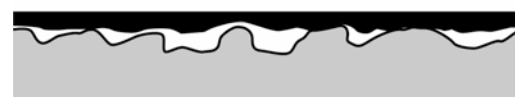
16s CA<sub>4</sub>40s CA<sub>4</sub>

# Paint

Looking at a painted object will tell us that paint is hard. However, the paint which we spray is a liquid.

This transformation is due in the main part to several components of paint whose functions are described below.

## Components of paint

Paint contains one or more substances which are generally dissolved in a solvent (or in water) and which regain their solid consistency after drying on the surface.

**Amongst these substances, we find :**

- » Binders
- » Pigments
- » Fillers

The binder is generally a more or less transparent body which resembles a resin. Dissolved on its own in a solvent it produces a lacquer:

**Binder + Solvent = Lacquer**

Paint often bears the name of the type of solvent on which it is based (cellulose paint is based on a cellulose solvent). To darken the finish, we add highly colored and very fine powders, which we call pigments:

**Binder + Solvent + Pigments = Paint**

### Dry and wet layer

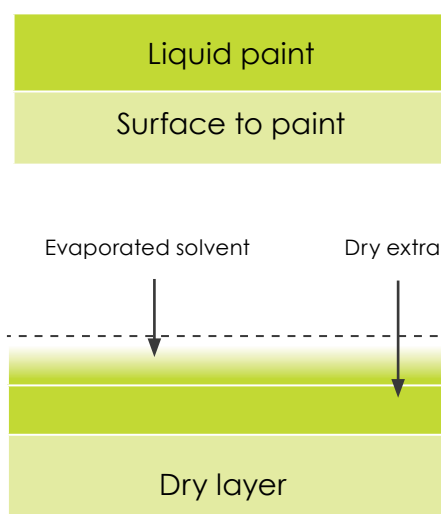

## GLOSSARY

» **Sticky film :**  
we say that a film is sticky when we put a finger on it and it feels like adhesive tape

» **Dust-free film :**  
we say that the film is dust-free, when any dust which lands on it can be removed by blowing

» **Film that is dry to the touch :** we say that the film is dry to the touch when a finger does not leave a mark on the surface.

» **Finger-nail hard :** we say that the film is finger-nail hard when we cannot mark it. In this state, it can be polished or sanded.

## Paint

Finally, to give the finish specific characteristics, we use a whole range of fillers and additives. Solvents make it possible to dissolve the other components of the paint, and can be classed into the following three groups:

» **Fast solvents** : they evaporate extremely quickly, to such an extent that the paint can dry too quickly, not allowing it enough time to adhere correctly to the surface.

These solvents are never used on their own.

» **Slow solvents** : they evaporate very slowly, allowing the paint to adhere properly. They leave a soft and smooth finish. Slow solvents are not very widely used because they significantly increase the drying time.

» **Medium solvents** : they evaporate in a few seconds ; this is enough to ensure good adhesion, while giving a satisfactory drying time.

In order to make the correct paint, the manufacturer first of all makes a list of the solvents capable of dissolving all the binders he wishes to include, and then chooses those with a volatility suitable for the planned method of drying (whether at room-temperature or in an oven). Before application, paint is often reduced to give a consistency which is ideal for the task.

## Paint consistency

## Viscosity

The consistency of the paint should be adapted for the type of application. It is identified by the extent of its viscosity, which is expressed in centipoises or by measuring the time in seconds that it takes for a certain amount of paint to run through a calibrated viscosity cup. There are different viscosity cups used for measuring the viscosity of paints. The table below shows the relationship between cup size and viscosities in Centipoises.

AFNOR 4 (CA4)	ISO 4	mPas.s	Centipoises	Ford 4 (CF4)	DIN 4 (D°)	CH (Fr)	ZAHN (n°2)
12	-	20	20	10	11	6	18
14	17	25	25	12	12	7	19
16	23	30	30	14	14	-	20
20	34	40	40	18	16	8	22
25	51	50	50	22	20	9	24
29	60	60	60	25	23	10	27
32	68	70	70	28	25	-	30
34	74	80	80	30	26	11	34
37	82	90	90	33	28	12	37
40	93	100	100	35	30	13	41
45	-	120	120	40	34	14	49
50	-	140	140	44	38	15	58
56	-	160	160	50	42	16	66
61	-	180	180	54	45	17	74
66	-	200	200	58	49	18	82
70	-	220	220	62	52	19	-

Nota: 1 poise = 100 centipoises and 1 mPas.s = 1 centipoise (If the density of the paint is equal as 1 and if it is a fluid Newtonien, that is to say no thixotrope).

## The effect of temperature on viscosity

Viscosity of paint changes with variations in temperature; basically, the resins are far more fluid when they are hot.

The table below shows the changes in viscosity of a glycerophthalic paint as the temperature varies. It is worth noting that a paint which has a viscosity of 22s at 68°F will have a viscosity of 28s at 54°F and of 17s at 90°F.

		Temperatures (°C)																			
		2	4	6	8	10	12	14	16	18	20	22	24	26	28	30	32	34	36	38	40
v i s c o s i t y		27	26	24	23	22	21	21	20	19	18	18	17	17	16	15	15	14	14	14	14
		33	31	29	27	26	25	23	22	21	20	19	18	18	17	16	16	15	15	14	14
		39	36	34	32	30	28	26	24	23	22	21	20	19	18	17	17	16	15	15	14
		46	42	39	36	34	31	29	27	26	24	23	22	21	19	18	17	17	16	15	15
		54	49	45	41	38	35	32	30	28	26	24	23	21	20	19	18	17	17	16	15
		56	51	47	43	40	36	33	31	29	27	25	23	21	20	20	19	18	17	16	16
		61	55	50	46	42	38	35	32	30	28	26	24	22	21	20	19	18	17	16	16
		69	63	56	52	46	42	39	35	32	30	28	25	24	23	21	20	19	18	17	16
		77	69	62	55	50	46	41	38	35	32	29	27	25	24	22	21	19	18	17	16
		84	74	67	61	54	50	44	40	36	34	30	28	26	25	23	22	20	18	17	16
s e c o n d s		95	84	75	66	60	54	48	44	40	36	33	30	28	26	24	22	20	19	18	17
		104	92	81	73	65	58	52	46	42	38	35	31	29	27	24	23	21	20	19	18
		112	100	88	76	69	62	54	49	44	40	36	32	30	27	25	23	21	20	19	18
		122	108	90	85	75	66	59	53	47	42	38	35	31	28	26	24	22	21	19	18
C F # 4		132	120	102	90	80	70	63	55	50	44	40	36	33	30	27	25	23	22	20	18
		142	124	108	95	84	74	65	58	52	46	41	37	34	31	27	25	23	22	20	18
		152	132	119	101	90	80	69	61	54	48	43	38	35	31	28	26	24	23	21	18
		164	140	123	106	94	83	73	64	56	50	45	40	36	32	29	27	24	23	21	18

Example : at a temperature de 20°C for an announced viscosity of 22s, you should be ready for the following results:

- at 12°C, a viscosity of 28s,
- at 32°C, a viscosity of 17s.

## Paint

Quality problems tend to arise when the temperature of the paint changes during the course of the day. For example : During the course of this day, the viscosity of the paint has moved from 23 to 17 seconds, which leads to a 22 % increase in the output of the spray guns, leading to over-coloring and excessive product consumption.

	Temperatures (°C)	Viscosity - CA4 (seconds)	Spray gun output (cm3/mm)
morning, cool workshops	15	23	460
Later - workshop heats up	20	20	520
An oven switched on	25	17	560

Worse still, paint prepared in a hot workshop at 20 seconds can be at 28 seconds the following morning, before the workshop has got up to full working temperature: this would lead to a less fine spray and a much greater drying time.

## Drying of paints

he component of paint can be classed in two groups :

» Dry extracts

» VOC (Volatile organic compounds), or water in case of water-based paints

Drying paint is all about allowing the volatile products to evaporate and the film to harden. We must distinguish between hardening and drying.

Drying gives us the dry film purely by the evaporation of the volatile products. This happens at two stages: during spraying and within the film. Depending on the temperature, the density of the spray, the type of spray gun and the distance of the spray, the paint can arrive on the surface more or less dry. That means that the majority of the solvent has evaporated before the paint reaches the surface. The drying of the wet film is accelerated when the surface is in a well-ventilated area which has dry air and is dust-free.

# PRACTICAL PAGES

## Choosing a pump

### To optimize

- For the best pump capacity, first work out the output you are going to require. This will include the sprayguns themselves, and any circulation you plan to have within this system. Once you have this figure, multiply by 1.2, and then choose the pump of which output at 15 cycles per minute is the nearest.
- The compression ratio you will need is defined by the pressure losses due to the length and diameter of the hosing of your system. To calculate these pressure losses, **see page 95**.

### Example

Let say you want to feed 1 AIRLESS® gun equipped with a 18.13 (519) tip. Referring to the chart on **page 22**, this tip will flow 1.6L at 200B fluid pressure. And your material is having a viscosity of 5000 cps. The part to spray on is at 10m from the pump and you will use a 9.5mm hose + 1m whip end with 4.8mm Internal diameter.

**1st :** calculate the fluid output per cycle appropriate for a piston pump :  
 $1.6 \text{ L} / 15 \text{ cycle} = 0.106\text{L/cycle}$  or 106 cc/cycle

**2nd :** calculate your pressure drop (refer to **page 95**)

L1 of 20m will loose 67 bars

L2 of 1m will loose 100 bar

In total, the pump must deliver at minimum 367 Bar to achieve the job properly.

What will be the best suitable pump :

» 35C50 : either the section is too small : only 50cc/cycle and the pressure ratio also : maximum fluid pressure of 210B --> do not choose this pump

» 40C100 : the hydraulic section of 100cc/cycle is well dimensioned to deliver the require paint flowrate BUT the pressure ratio of 40/1, is

not enough, because delivering at maximum 240 Bar --> do not choose this

» 72C160 : the section of 160cc/cycle is really well design AND the maximum fluid delivery will be 432B which is also enough for the job --> this pump is your best choice for this specific example

## Pump Material Feeding

To guarantee the right delivery of product, we offer the following range of equipment for various product viscosity :

» 0 - 300 cps

- suction rod.

» 300 to 8 000 cps

- top outlet pressure pots,
- pumps (gravity or suction rod),
- pump with base intake valve.

» 8 000 to 15 000 cps

- bottom outlet pressure pots,
- pumps with suction rods,

- compressor.

» 15 000 to 30 000 cps

- no more pressure pot,
- no more suction rod,
- submerged hydraulic pump,
- compressor,
- pump with single action elevator.

» 30 000 à 1 000 000 cps and +

- pumps with peak feeder and double action elevator.

## PRACTICAL PAGES

## Filtration equivalence

Mesh (number of holes in 25,4 mm)	Micron	N° filter (mesh opening in µm)
10	1480	–
16	975	–
20	750	30
25	630	25
30	500	20
40	375	–
45	360	15
50	300	12
60	238	–
70	210	8
80	175	6
100	149	–
140	100	4
170	90	3
200	74	–
250	60	–
270	50	2
325	40	1
400	35	–

## Pressure loss in fluid hoses

Pressure drop is the resistance that prevents material from moving forward in the pipe. Two pipe variables influence this resistance : the (inside/internal) diameter and the pipe length. The pump will generate a pressure, strong enough to move the fluid material through the pipe (or hose) to the material pipe outlet. This pressure must be enough to overcome the original pressure drop. While it is hard to reduce the pipe length, it is relatively easy to select an appropriate internal pipe diameter.

## PRESSURE DROP CALCULATION

$$\text{Pressure loss (bar/m)} = \frac{6.9 \times \text{Flow (l/min)} \times \text{Viscosity (cps)}}{D^4 \text{ (int dia in mm)}}$$

$$\text{Pressure loss (psi/Ft)} = \frac{2.73 \times \text{Flow (gpm)} \times \text{Viscosity (cps)}}{D^4 \text{ (int dia in inches)}}$$

## FLOW RATE CALCULATION

$$\text{Flow (l/min)} = \frac{\text{Pressure loss (bar/m)} \times D^4 \text{ (int dia in mm)}}{6.9 \times \text{Viscosity (cps)}}$$

$$\text{Flow (gpm)} = \frac{\text{Pressure loss (psi/Ft)} \times D^4 \text{ (int dia in inches)}}{2.73 \times \text{Viscosity (cps)}}$$

## PIPE DIAMETER CALCULATION

$$\text{Interior Dia (mm)} = \sqrt[4]{\frac{6.9 \times \text{Flow (l/min)} \times \text{Viscosity (cps)}}{\text{Pressure Loss (bar/m)}}}$$

$$\text{Interior Dia (in)} = \sqrt[4]{\frac{2.73 \times \text{Flow (gpm)} \times \text{Viscosity (cps)}}{\text{Pressure loss (psi/Ft)}}}$$

PRACTICAL PAGES

**Pressure loss in air hoses**

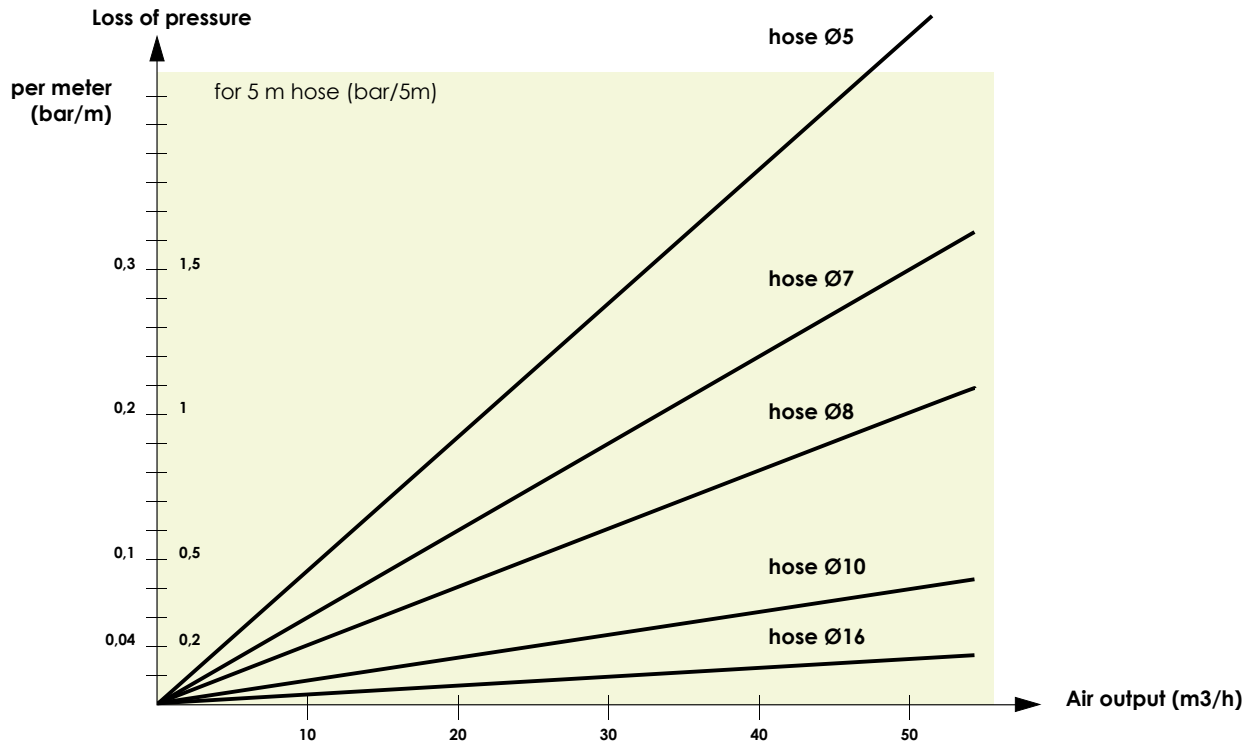

**Electrostatic spraying : suitability of the equipment depending on the resistivity of the paints**

- The wrap-around affect is optimized with paints of resistivity range of 5 - 50 MΩ.cm.
- Specific hoses allows for wrap-around effects for resistivity range higher than 2MΩcm.
- For water-based materials (0 MΩ.cm), a special ISObubble enclosure allows to benefit from all the advantages of electrostatic spraying in complete safety.

**List showing the compressed air consumption of normal air tools**

We generally multiply the instant consumption by a coefficient of 0,5 to 0,9 to allow for the time the tool is not in use.

The average air volume delivered by a compressor of 1 CV is of 8 m<sup>3</sup>/h.

Tool	Consumption	
	l/mn	m <sup>3</sup> /h
Projection equipment	800 at 1 800	48 at 108
Riveter	450 at 1 500	27 at 90
Pneumatic drill	600 at 1 200	36 at 72
Linisher Ø 230	1 200 at 4 000	72 at 240
Drill 13 mm	600	36
Rotating sander	200 at 400	12 at 24

Tool	Consumption	
	l/mn	m <sup>3</sup> /h
Conventional gun	160 at 500	10 at 30
AIRLESS@ gun	67 at 134	4 at 8
Pumps	160 at 1 350	10 at 80
Blower	200 at 400	12 at 24
Screwdriver	200 at 400	12 at 24

**Calculate exactly the maximum air consumption of pump in l/mn : Q**

The formula is :

$$Q = 1.2 \times \text{fluid output} \times \text{pressure ratio} \times (\text{air motor feeding pressure in bar} + 1 \text{ bar for atmosphere})$$

Example for a pump 16.120 :  $Q = 1.2 \times 4,8 \times 16 \times (6 + 1) = 645.12 \text{ l/mn}$  or  $(645.12 \times 60) : 1000 = 38.7 \text{ m}^3/\text{h}$



PRACTICAL PAGES

Value of « PH »

The pH value of a liquid or a solution quantifies its concentration of hydrogen ions and tells us the extend to which it is acidic or alkaline. The PH value dictates the best materials to be used in construction of major paint handling and spraying equipment.

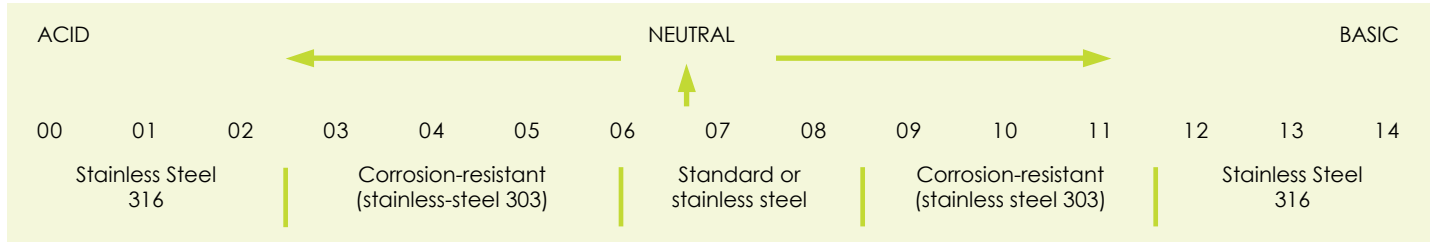

Practical information:  
Metric - english conversion

CONVERT FROM	TO	MULTIPLY BY
Centimeters	feet	0.03280
Centimeters	inches	0.3937
Centimeters/min.	feet/min.	1.9684
Centimeters/sec.	feet/sec.	0.03281
Cubic centimeters.	cubic feet	3.5314 x 10 <sup>-5</sup>
Cubic centimeters	ounces	0.033
Cubic centimeters	liquid gallons	0.0002642
Cubic feet	liquid gallons	7.4805
Cubic feet	cubic inches	1.728
Cubic feet/min.	gallons/min.	7.4805
Cubic inches	gallons	0.004329
Cubic inches	cubic centimeters	16.387
Cubic inches	cubic feet	0.0005787
Cubic meters	liquid U.S. gallons	264.17
Cubic meters	cubic centimeters	1 x 10 <sup>6</sup>
Cubic meters	cubic feet	35.31
Cubic meters	cubic inches	61,023.38
Feet	centimeters	30.48006
Feet	meters	0.3048006
Feet of water	atmosphère	0.02949
Feet of water	psi	0.443
Feet/hour	miles/hour	0.00018933
Feet/min.	meters/min.	0.3048
Feet/min.	miles/hour	0.01136
Feet/sec.	miles/hour	0.681818

CONVERT FROM	TO	MULTIPLY BY
Gallons	cubic cm	3 785.43
Gallons	cubic inches	231
Gallons	imperial gallons	0.83268
Gallons	cubic feet	0.13368
Gallons/min.	cubic feet/min.	0.13368
Inches	feet	0,083333
Inches	meters	0,254
Inches	millimeters	25,40005
Inches	mils	1 000
Kilograms	pounds	2,2046
Kilogrammes/cm <sup>2</sup>	psi	14,2233
Kilogrammes/mm <sup>2</sup>	psi	1 422,33
Liters	gallons	0,264178
Meters	feet	3,2808
Meters	inches	39,37
Poise	centipoise	100,0
Pints of water	gallons	0,11985
PSI	atmosphère (bar)	0,06804
Inches <sup>2</sup>	cm <sup>2</sup>	6,4516
Inches <sup>2</sup>	feet <sup>2</sup>	0,006944
Inches <sup>2</sup>	mm <sup>2</sup>	645,163
Millimètres <sup>2</sup>	inches <sup>2</sup>	0,0015499
daN	Kilograms	1.0

- » For the diameter of a circle, multiply the circumference by 0.31831.
- » For the circumference of a circle, multiply the diameter by 3.1416.
- » For the surface of a circle, multiply the diameter<sup>2</sup> by 0.7854.
- » For the surface of a sphere, multiply the diameter<sup>2</sup> by 3.1416.
- » To find the side of a square that has the same surface area of a circle, multiply the diameter by 0.8862.
- » To find the number of cubic inches in a sphere, multiply the diameter by 0.5236.
- » To find the number of gallons inside a pipe or cylinder, divide the volume in liters by 231.
- » To find the cubic volume of a cylinder or pipe, multiply the section area by the length.

# PRACTICAL INFORMATION

## Chemical compatibility charts

### MATERIAL IN CONTACT (Wetted Parts)

	Carbon steel	Aluminium	Brass	Stainless steel	Nylon	Nitrile	Vitton	Leather	P.U.
Butyl acetate	•••	•••	•••	•••	•••	N	N		N
Ethyl acetate	••	••	••	••	•••	N			
Acetaldehyde	•••	•••	•••	•••	•••	N	N	••	N
Amonium acetate				•••					
Acedic acid	•••			•••	•••	N	N	N	N
Boric acid	•••	•••		•••	•••		•••	•••	•••
Hydrobromic acid					•••	N	•••		
Chloridic acid	N	N		N	•••	N	•••		
Chromic acid	N	N	N	•	•••	N			
Citric acid				•••	•••		•••		
Fluorohydric acid						N	•••		
Fluosilicic acid			•••		•••	N	N		
Formic acid	N	••	N	•	•••	N	•		
Nitric acid	N	N	N	•••	•••	N	•••		
Oxylic acid	N	N	N	N	•••		•••	•••	•••
Phosphoric acid	N	N		•••	•••	N	•••		
Ethylalcohol						•••	N		
Methylalcohol	•••						N	•••	N
Acetic aldehyde	•••	•••		•••	•••	N	N		N
Formic aldehyde	N	••	N	N	•••	N	•••		N
Sodium algenate					•••		N		
Starch						•••	•••		
Amines					•••	N	N	N	
Acetone	•••	•••		••	•••	N	N		N
Liquid ammonia	•••	•••		•••	••	••	N	N	
Benzene	•••	•••	•••	•••	•••	N	•••	••	•
Sodium bicarbonate		N	N	•••	•••	•••	•••		
Chlorine dioxide						N	•••		
Sodium bisulphate	N	N		N	•••	N	•••		
Brominate						N			
Calcium carbonate	•••			•••	•••	•••	•••	•••	
Sodium carbonate					•••		•••		
Chlorinate, gas						•••	•••		
Sodium chlorite							•••		•••
Aluminum chlorosulfate					•••	•••	•••	•••	
Calcium chloride	•••			•••	•••		•••		•••
Magnesium chloride	••	N		N	•••	•••	•••	•••	•••
Potassium chloride	N	N		••	•••	•••	•••	•••	•••
Sodium chloride					•••	•••	•••		•••
Zinc chloride	N	N		N	•••	•••	•••		•••
Ferrous chloride	N	N	N	N	•••		•••		
Ferric chloride	N	N	N	N	•••		•••		•••
Cyclohexane	•••	•••	•••	•••	•••	•••	•••		
Chlorobenzene	•••			•••	•	N	•••		N
Ethylene chloride		••			••	N	••		N
Methylene chloride	••	N	••	••	N	N	••		N
Diatoms						•••	•••		
Dichloroethylene					•••				
Diethylene glycol	•••	••		•••	•••	•••	•••		N
Bleach	N	••		•••	•••				•
Distilled water	N	•••	•••	•••	•••		•••	•••	•••
Oxygenated water	N		N	••	N		••		•••
EDTA						•••	N		
Fertilizer						•••	N		

# PRACTICAL INFORMATION

## Chemical compatibility charts

### MATERIAL IN CONTACT (Wetted Parts)

	Carbon steel	Aluminium	Brass	Stainless steel	Nylon	Nitrile	Vitton	Leather	P.U.
Ethanol					●●●	●●●	N		
Ethyl ether	●●	●●		●●	●●●	N	N		●
Ethylene glycol	●●	●●	●●●	●●	●●●	●●●	●●●		N
Ethyl-mercapan						N	●●●		
Fuel						N	●●●		
Fluosilicate			●●●		●●●	●●●	●●●		
Formaldehyde	N	●●		N	●●	●●●	●●●		N
Glycol	●●	●●		●●	●●●	●●●	●●●		N
Gelatine	N	●●		●●●	●●●	N	N		N
Sodium hydroxide					●●●	N	N		N
Ammonium hydroxide				●●●	●●●	N	N	●●	N
Potassium hydroxide	●	N		●●	●●●	N	N		N
Calcium hypochlorite				●	●●●	N	●●●	N	
Sodium hypochlorite					●●●	N	●●●		N
Sodium hyposulfite					●●●	N	●●●		
Fruit juice						●●●	●●●		
Methanol	N	●●●		●●●			N		●
Morpholine	●●●	●●●				N	N		
Methylethylcetone	●●●	●●		●●●	●●●	N	N		N
Sodium nitrite					N	N	●●●		
Perchlorethylene (tetrachloret.)	●●●	●●		●●●	N	●●	●●●		N
Permanganate de potassium	●●	●●		●●	●●●	N	●●●		
Hydrogen peroxide	N	●●●	N	●●		N	●●		
Chlorohated Peroxyde						N	●●●		
Phenol	N	N			●●●	N	●●●		
Ammonium phosphate			●●●	●●●	●●●	●●●	●●●		
Tridsodium phosphate	●●●	N		●●●	●●●	●●●	●●●		
Aluminium polychlorite						●●●	●●●		
Polyelectrolytes						●●●	●●●		
Caustic potash		N		●●●		N	●●●		
Sodium silicate					●●●	●●●	●●●		
Soda						N	N		
Aluminium sulfate					●●●	●●●	●●●	●●●	N
Ammonium sulfate					●●●				●●●
Calcium sulfate	●●●	●●●		●●●	●●●		●●●		
Copper sulfate				●●●	●●●	●●●	●●●		●●●
Ferrous sulfate		N		●●	●●●	●●●	●●●		
Ferric sulfate	N	N		N	●●●	●●●	●●●		●●●
Sodium sulfate	N				●●●	●●●	●●●		
Hydrogen sulfur	●●●				●●●	●●●	N		
Carbon tetrachloride	●●		●●●	●●●	●●●	N	●●●		
Toluene	●●●	●●●		●●●	N	N	●●●		N
Trichlorethane	●●	N		●●	N	N	●●●		N
Trichlorethylene	●●	●●●		●●	N	N			N
Triethyleneglycol				●●	●●●		●●●		
Urea	●●	●●		●●	●●●		●●●		
Xylenes	●●	●●		●●	●●●	N	●●●		N

●●● = High Compatibility  
 ●● = Good Compatibility

● = Low Compatibility  
 N = Not Compatible

# Bond | Protect | Beautify

With our manual guns, automatic and robotic applicators, supplied by our wide range of pumps & machines for fluid handling, dosing, mixing & dispensing.

**SAMES KREMLIN** provides industrial solutions for production increase, quality improvement, material & cost savings.

We are designers and manufacturers of process equipment that is divided into **6 ranges**:

**Airspray:** Since 1925, we have been an Airspray manufacturer bringing you the very best in finishing.

**Airmix®:** Creator of Airmix® Technology since 1975, we provide the perfect mix between quality and productivity.

**Airless®:** We provide premium Airless Products for finishers with demanding applications.

**High Viscosity:** Pumping beyond possible, dispensing precisely.

**Electrostatic:** expertise for high finishing quality & efficiency.

**Powder:** Powder coating solutions for the highest Productivity since 1960.

FIND YOUR  
LOCAL CONTACT  
BY FLASHCODE:



[www.sames-kremlin.com](http://www.sames-kremlin.com)



13 chemin de Malacher - CS 70086  
38243 MEYLAN Cedex - FRANCE  
Phone: +33 (0)4 76 41 60 60 - Fax: +33 (0)4 76 41 60 90