

SAMES  **KREMLIN**

General Catalog

Fluid materials

North American Edition



Experts in Finishing and Dispensing Solutions



Over the past 85 years, Kremlin Rexson has been working in the **finishing and dispensing business, offering a wide range of equipment to industrial markets globally.**

Our equipment is designed with two objectives :

- ▶ to continuously innovate and adapt to all new coatings arriving on the market (water-based, high solids, new generation adhesives...)
- ▶ to reduce operating costs by increasing transfer efficiency while minimizing maintenance.

All our equipment is compliant with existing regulations and their performances help reduce VOC (Volatile Organic Compounds).

This general guide will let you discover our full range of equipment for liquid materials and help you to select the best possible equipment for your particular application.

For additional information, please visit our website

www.kremlinrexson-sames.com/en/usa/

Airspray Equipment

- ▶ Airspray manual gun and accessories
- ▶ Airspray automatic guns
- ▶ Airspray gun feeding
- ▶ Hot spraying
- ▶ Airspray circulation
 - Color change valves
- ▶ Low-pressure regulators
- ▶ Filtration
- ▶ Agitators
- ▶ Low-pressure hoses
- ▶ Accessories miscellaneous

15 - 88

AIRMIX® Equipment

- ▶ AIRMIX® manual gun and accessories
- ▶ AIRMIX® automatic guns
- ▶ AIRMIX® pumps
- ▶ Hot spraying
- ▶ AIRMIX® circulation
 - Color change valves
- ▶ AIRMIX® regulators
- ▶ Filtration
- ▶ Agitators
- ▶ AIRMIX® hoses
- ▶ Accessories miscellaneous

91 - 150

AIRLESS Equipment

- ▶ AIRLESS manual gun and accessories
- ▶ AIRLESS automatic guns
- ▶ AIRLESS pumps
- ▶ Filtration
- ▶ Agitators
- ▶ AIRLESS hoses
- ▶ Accessories miscellaneous

153 - 175

Electrostatic Equipment

- ▶ Manual electrostatic guns
- ▶ Manual electrostatic guns H₂O
- ▶ Automatic electrostatic guns
- ▶ Specific electrostatic equipment

177 - 199

Plural component Pumps and Machines

- ▶ Mechanical mixing
- ▶ Electronic mixing

201 - 209

Fittings and Air Treatment

- ▶ Fittings, adapters, elbows
- ▶ Air treatment

211 - 220

OUR MARKETS



FURNITURE

All manual or automatic process furniture finishes: varnishes, lacquers, waxes, stains.
One or two component electrostatic applications.
One or two component, sprayed, extruded or bonding.



KITCHENS AND BATHROOMS

All manual or automatic process furniture finishes: varnishes, lacquers, waxes, stains.
One or two component electrostatic applications.
One, two or three component sprayed or extruded bonding.
Moving parts lubricating.



WINDOWS AND DOORS

All process finishing: varnishes, lacquers, waxes, one or two component stains.
One or two component sprayed or extruded bonding.



AEROSPACE

One, two or three components, electrostatic applications.
Structural finishing and solutions. Composites structural sealing and bonding.
Component protection and finishing.
Non-destructive testing.



ROLLING EQUIPMENT

One or two component sealing, protection and finishing of agricultural machinery, railways, buses, building equipment.
Structural one or two component bonding (sandwich panels, windscreens, body...).



BICYCLES AND MOTORCYCLES

Manual or automatic one or two component finishing of bicycles and motorcycles.
Conventional and electrostatic applications.



APPLIANCES

Finishing, bonding and lubrication of appliances:
washing machines, stoves, refrigerators.



SPORTING AND CONSUMER GOODS

One or two component bonding and finishing of consumer, leisure and sporting goods.



CONSTRUCTION EQUIPMENT

Medium or high pressure one or two component application for building components such as steel frames, cranes, etc.



MACHINE TOOLS

One or two component machine tools and component protection and finishing.
Manual, automatic and electrostatic applications.



RENEWABLE ENERGIES (WIND/SOLAR)

Infusion, bonding, protection and finishing of wind turbines and solar panels.
One or two component paints, gel-coats, resins and adhesives applications.
Lubricating systems.



EXTERIOR AUTOMOTIVE - PLASTIC COMPONENTS

Complete solutions for paint application on plastics.
Both electrostatic and non-electrostatic robotic integration.
One or two component application, electrostatic applications.
Paint distribution. Lubricating systems.



INTERIOR AUTOMOTIVE - PLASTIC COMPONENTS

Complete solutions for paint and soft touch application on plastics.
Electrostatic robotic line integration.
One or two component application, electrostatic applications.



PLASTICS

One or two component meter mixing for electronic component finishing.
Manual and automatic electrostatic and non-electrostatic finishing.



LEATHER

Manual or automatic stain and varnish applications.
Manual and automatic leather and foam bonding.



GLASS COATING

Decoration and finishing of bottles, for containers & flat panels.
Manual or automatic applications.



DRUMS AND CONTAINERS

Finishing protection and reconditioning of drums, containers and gas bottles:
solvent or water-based manual or automatic applications.

ATEX DIRECTIVE (POTENTIALLY EXPLOSIVE ATMOSPHERE)

All KREMLIN REXSON equipment to be used in potentially explosive atmospheres are compliant with 94/9/CE Directive
ATEX 94/9/CE Directive (For manufacturers) : This directive defines essential requirements for security: take into account security against explosion during design, display the CE marking, establish a CE conformity declaration, supply an instruction manual.

©2016 EXEL North America Inc. All Rights Reserved.

All written and visual data contained in this document are based on the latest product information available at the time of publication. EXEL North America Inc. reserves the right to modify and or make changes to this document at any time without notice.

PAINTS

Decoration and protection are functions associated with paint. To achieve this and to re-finish products, we have at our disposal a tremendous number of surface treatments, (for example nickel or chrome plating etc.).

Paint is also perfect for both of these functions. In addition, paint is universally used and can be applied on any surface, such as wood, metal, stone, leather, plastic and elastomers. Paint does not come as a finished product, therefore the quality of application will depend on all its stages of preparation, which we will call the "Painting System".

In general , the stages are as follows:

- ▶ Surface preparation
- ▶ Application of the coating (paints, stains, varnishes, etc...)
- ▶ Drying

RECOMMENDED PAINT FAMILIES, WATER-BASED OR SOLVENT-BASED FOR KREMLIN REXSON EQUIPMENT.

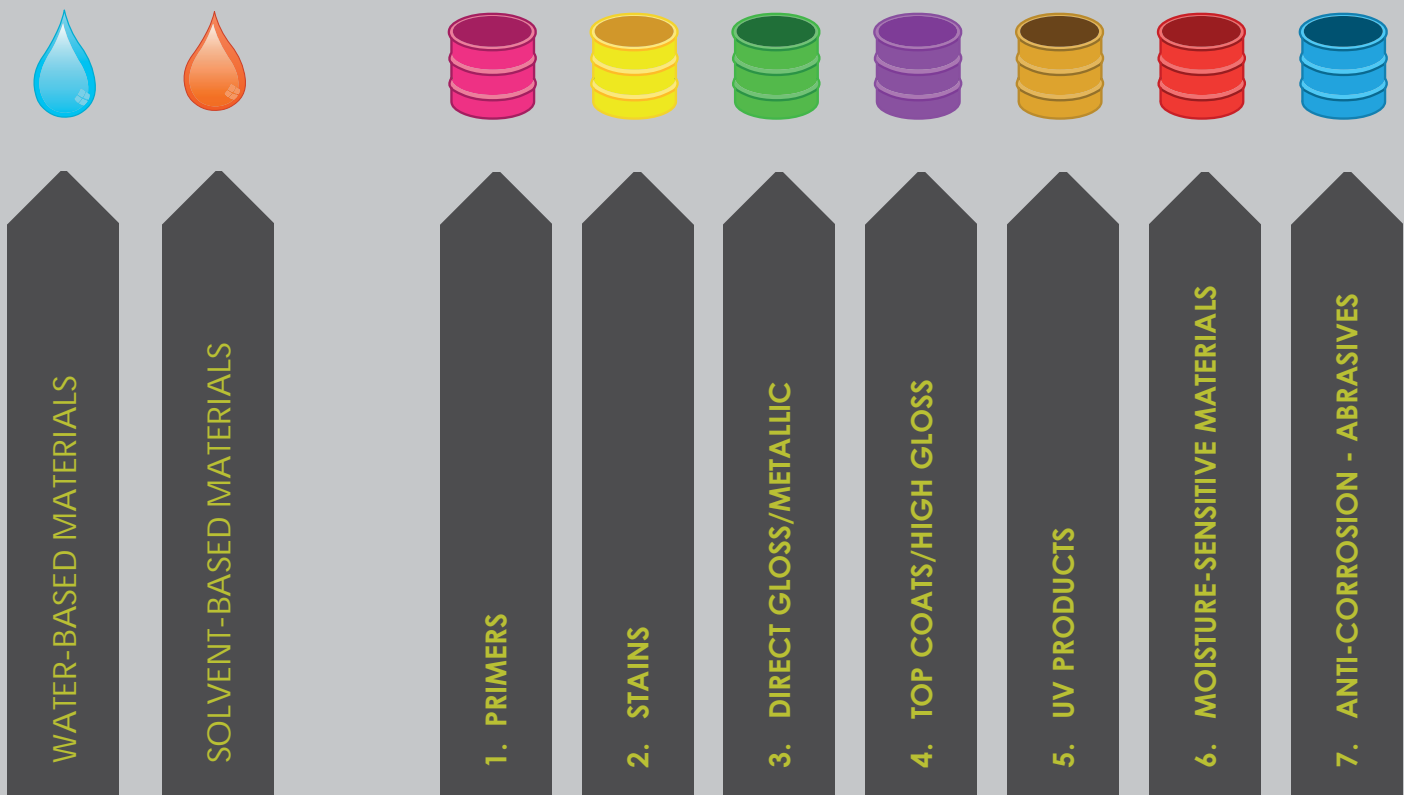

SURFACE PREPARATION

There is a wide range of physical and chemical treatments to which the surface to be coated can be subjected before receiving the first coat.

Good surface preparation is essential for long-lasting protection and a good visual finish on any material.

The surface preparation is often the longest and most important task involved in coating a part.

Material	Physical Preparation	Chemical preparation
Steel	stripping, shot blasting, brushing	acid
Aluminum	brushing	vapor blast
Wood	sanding	
Plastic	heating	plasma torch, acid

Once treated, the surfaces should be free from:

- ▶ particulate or non-adherent substances
- ▶ oil, grease and moisture

To obtain the best protection against corrosion (mainly for metal), coat with either:

- ▶ wash primer
- ▶ anti-corrosion paint

A wash primer is a liquid product of around 16s Zahn #2, which should be sprayed in a thin coat, to get into all the imperfections in the surface of the metal. The phosphoric acid which it contains attacks the surface of the metal and forms an isolating and impenetrable layer of phosphate. The wash primer is highly valued for its adhesion to the metal. Importantly, it should then be coated with a layer of paint, which plays the role of a protective shield.

An **anti-corrosion** paint is a product which should be sprayed in a thicker layer than the wash primers. Containing anti-corrosive elements, it has the advantage of protecting the metal both physically and chemically at the same time. Also, it saves time, as a single coat applies both the anti-corrosive chemicals and the protective shield to the metal.

These paints are used very frequently on metal framework, as the coating can be left as it is, or covered subsequently with the desired paint finish.



16s CA₄



40s CA₄

PAINTS

Looking at a painted object tells us that paint is hard. However, the paint which we spray is a liquid.

This transformation is due in the main part to several components of paint whose functions are described below.

COMPONENTS OF PAINT

Paint contains one or more substances which are generally dissolved in a solvent (or in water) and which regain their solid consistency after drying on the surface.

Substances

BINDERS - PIGMENTS - FILLERS

The binder is generally a transparent body which resembles a resin. Dissolved on its own in a solvent it produces a lacquer :

Binder + Solvent = Lacquer

Paint often bears the name of the type of solvent on which it is based (cellulose paint is based on a cellulose solvent). To darken the finish, we add highly colored and very fine powders, which we call pigments. :

Binder + Solvent + Pigments = Paint

Finally, to give the finish specific characteristics, we use a whole range of fillers and additives. Solvents make it possible to dissolve the other components of the paint, and can be classed into the following three groups:

- ▶ **Fast solvents:** they evaporate extremely quick, to such an extent that the paint can dry too quickly, not allowing it enough time to adhere correctly to the surface. These solvents are never used on their own.
- ▶ **Slow solvents:** they evaporate very slowly, allowing the paint to adhere properly. They leave a soft and smooth finish. Slow solvents are not very widely used because they significantly increase the drying time.
- ▶ **Medium solvents:** they evaporate in a few seconds; this is enough to ensure good adhesion, while giving a satisfactory drying time.

In order to make the correct paint, the manufacturer first of all makes a list of the solvents capable of dissolving all the binders he wishes to include, and then chooses those with a volatility suitable for the planned method of drying (whether at room-temperature or in an oven). Before application, paint is often reduced to give a consistency which is ideal for the task.

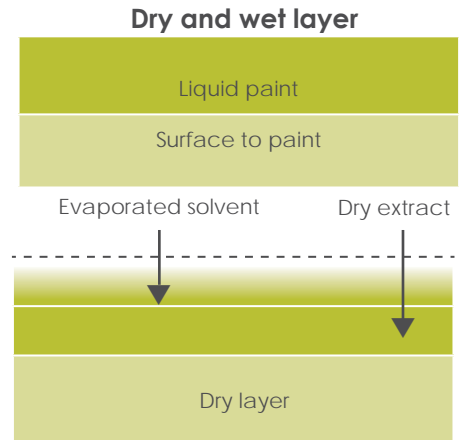

GLOSSARY

- ▶ **Sticky film :** we say that a film is sticky when we put a finger on it and it feels like adhesive tape
- ▶ **Dust-free film :** we say that the film is dust-free, when any dust which lands on it can be removed by blowing
- ▶ **Film that is dry to the touch :** we say that the film is dry to the touch when a finger does not leave a mark on the surface.
- ▶ **Finger-nail hard :** we say that the film is finger-nail hard when we cannot mark it. In this state, it can be polished or sanded.

THE CONSISTENCY OF PAINTS - VISCOSITY

The consistency of the paint should be adapted for the type of application. It is identified by the extent of its viscosity, which is expressed in centipoises or by measuring the time in seconds that it takes for a certain amount of paint to run through a calibrated viscosity cup. There are different viscosity cups used for measuring the viscosity of paints. The table below shows the relationship between cup size and viscosities in centipoises.

AFNOR 4 (CA4)	ISO 4	mPas.s	Centipoises	Ford 4 (CF4)	DIN 4 (D°)	CH (Fr)	ZAHN (n°2)
12	—	20	20	10	11	6	18
14	17	25	25	12	12	7	19
16	23	30	30	14	14	—	20
20	34	40	40	18	16	8	22
25	51	50	50	22	20	9	24
29	60	60	60	25	23	10	27
32	68	70	70	28	25	—	30
34	74	80	80	30	26	11	34
37	82	90	90	33	28	12	37
40	93	100	100	35	30	13	41
45	—	120	120	40	34	14	49
50	—	140	140	44	38	15	58
56	—	160	160	50	42	16	66
61	—	180	180	54	45	17	74
66	—	200	200	58	49	18	82
70	—	220	220	62	52	19	—

se = 100 centipoises et 1 mPas.s = 1 centipoise

THE EFFECT OF TEMPERATURE ON VISCOSITY

Viscosity of paint changes with variations in temperature; basically, the resins are far more fluid when they are hot.

The table below shows the changes in viscosity of a glycerophthalic paint as the temperature varies. It is worth noting that a paint which has a viscosity of 22s at 68° F (20° C) will have a viscosity of 28s at 54° F (12° C) and of 17s at 90° F (32° C).

		Temperature																		
°F	36°	39°	43°	46°	50°	54°	57°	61°	64°	68°	72°	75°	79°	82°	86°	90°	93°	97°	100°	
°C	2°	4°	6°	8°	10°	12°	14°	16°	18°	20°	22°	24°	26°	28°	30°	32°	34°	36°	38°	
Viscosities in seconds CF4	27	26	24	23	22	21	21	20	19	18	18	17	17	16	15	15	14	14	14	
	33	31	29	27	26	25	23	22	21	20	19	18	18	17	16	16	15	14	14	
	39	36	34	32	30	28	26	24	23	22	21	20	19	18	17	17	16	15	14	
	46	42	39	36	34	31	29	27	26	24	23	22	21	19	18	17	17	15	15	
	54	49	45	41	38	35	32	30	28	26	24	23	21	20	19	18	17	16	15	
	58	51	47	43	40	36	33	31	29	27	25	23	21	20	20	19	18	16	16	
	61	55	50	46	42	38	35	32	30	28	26	24	22	21	20	19	18	16	16	
	69	63	56	52	46	42	39	35	32	30	28	25	24	23	21	20	19	17	16	
	77	69	62	55	50	46	41	38	35	32	29	27	25	24	22	21	19	17	16	
	84	74	67	61	54	50	44	40	36	34	30	28	26	25	23	22	20	17	16	
	95	84	75	66	60	54	48	44	40	36	33	30	28	26	24	22	20	18	17	
	104	92	81	73	65	58	52	46	42	38	35	31	29	27	24	23	21	19	18	
	112	100	88	76	69	62	54	49	44	40	36	32	30	27	25	23	21	19	18	
	122	108	90	85	75	66	59	53	47	42	38	35	31	28	26	24	22	19	18	
	132	120	102	90	80	70	63	55	50	44	40	36	33	30	27	25	23	20	18	
	142	124	108	95	84	74	65	58	52	46	41	37	34	31	27	25	23	20	18	
	152	132	119	101	90	80	69	61	54	48	43	38	35	31	28	26	24	21	18	
164	140	123	106	94	83	73	64	56	50	45	40	36	32	29	27	24	21	19		

Example : at a temperature of 68° F for an announced viscosity of 22 s, you should achieve the following results:

- ▶ at 54° F (12° C), a viscosity of 28 s,
- ▶ at 90° F (32° C), a viscosity of 17 s.

Quality problems tend to arise when the temperature of the paint changes during the course of the day. For example: During the course of this day, the viscosity of the paint has moved from 23 to 17 seconds, which leads to a 22% increase in the output of the spray guns, leading to over-coloring and excessive product consumption.

	Temperature	Viscosity - CA4 (s)	Spray gun output
Morning, cool workshops	59° F (15° C)	23	15.5 oz/mn (460 cm ³ /mm)
Later - workshop heats up	68° F (20° C)	20	17.6 oz/mn (520 cm ³ /mm)
An oven switched on	77 F (25° C)	17	18.9 oz/mn (560 cm ³ /mm)

Worse still, paint prepared in a hot workshop at 20 seconds can be at 28 seconds the following morning, before the workshop has got up to full working temperature: this would lead to a less fine spray and a much greater drying time.

DRYING OF PAINTS

The component of paint can be classed in two groups :

- ▶ Dry extracts
- ▶ VOC (Volatile organic compounds), or water in case of water-based paints

Drying paint is all about allowing the volatile products to evaporate and the film to harden. We must distinguish between hardening and drying.

Drying gives us the dry film purely by the evaporation of the volatile products. This happens at two stages: during spraying and within the film. Depending on the temperature, the density of the spray, the type of spray gun and the distance of the spray, the paint can arrive on the surface more or less dry. That means that the majority of the solvent has evaporated before the paint reaches the surface. The drying of the wet film is accelerated when the surface is in a well-ventilated area which has dry air and is dust-free.

KEY

HPA	High Pressure Atomization (Conventional)	oz	ounces
HTi	High Transfer Innovation (HVLV)	fl. oz.	fluid ounces
c/w	comes with	in	inches
w/m	wall mount	ft	feet
c/m	cart mount	gal	gallon
p/m	pail mount	gal/mn	gallon per minute
psi	pounds per square inch	lbs	pound
bar	bar	°C	Celsius
mm	millimeter	°F	Fahrenheit
cm	centimeter	BSP	British Straight Pipe
m	meter	JIC	37-degree flare fitting
cc/mn	cubic centimeters per minute	cfm	Cubic feet/minute
l/mn	liter per minute	m ³ /h	Meters cubed/minute
g	gram	dBA	Decibel
kg	kilogram		

PERFORMANCES OF EACH SPRAYING TECHNOLOGY

TRANSFER EFFICIENCY (Maximum)

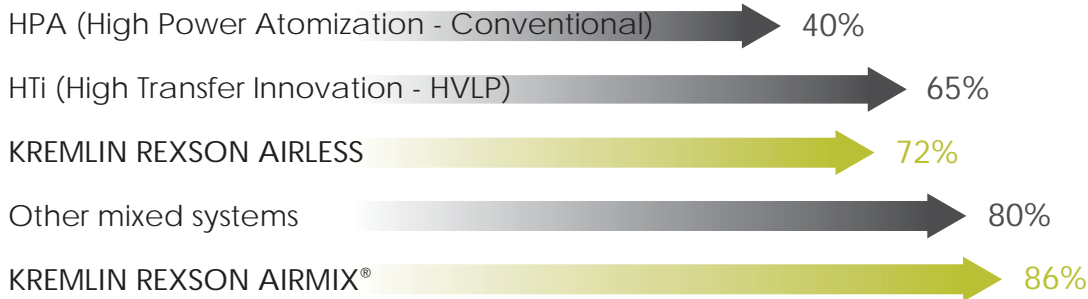

FINISH QUALITY

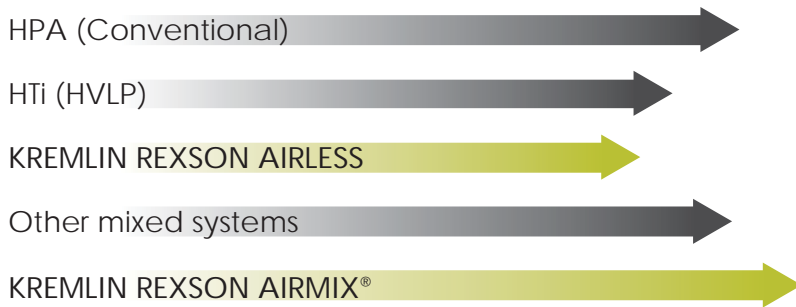

AVERAGE OUTPUT

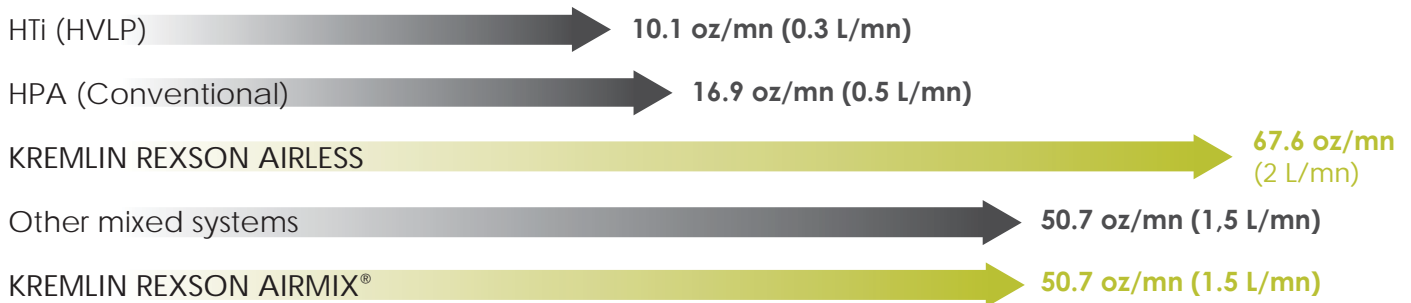

AIR CONSUMPTION

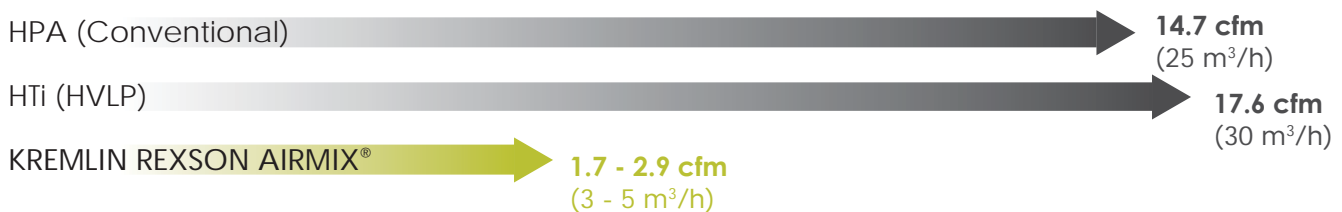

RECOMMENDED EQUIPMENT FOR YOUR - WOOD MANUAL APPLICATION

		SPRAYING										
Type of part	Fluids	Type	Example	2 components solvent/water based (primer, lacquer, varnishes)	Thick adhesives water/solvent	Solvent based adhesive	Primer, glaze	Hard finisher	Varnish, lacquer, glaze	Stains, fungicides, insecticides	Shades	Fluid consumption in gallons /day (liter/day)
				15'' to 90'' (up to 300)	(300 to 10 000)	45'' to 90'' (120 to 300)	30'' to 45'' (60 to 120)	20'' to 30'' (40 to 60)	15'' to 20'' -			
				motor oil	liquid honey	thick motor oil	motor oil	cooking oil	water			
HTI								M22 G HTi	S3		Less than 1.3 gal/day (5 L/day)	
				PU 2125 F or CYCLOMIX™ or PU 3000 + M22 P HTi	Pressure cup 2.5 quart or Pressure pot 2.5 gallon or PMP pump 150 mobile/wall-mounted or 02.75 + M22 P HTi						More than 1.3 gal/day (5 L/day)	
HPA				M22 G HPA M22 HPA GSP		M22 G HPA M21G Basic LP	S3				Less than 1.3 gal/day (5 L/day)	
				PU 2125F or PU 3000 or Cyclomix™ + M22 HTi	Pressure cup 2.5 quart or Pressure pot 2.5 gallon or PMP pump 150 mobile/wall-mounted or 02.75 + M22 HPA						More than 1.3 gal/day (5 L/day)	
AIRMIX®				PU 2160 or PU 3000 or CYCLOMIX™ + Xcite™	EOS 15-C25 or 30-C25 + Xcite™						1.3 - 3.9 gal/day (5 - 15 L/day)	
				PU 3000 or CYCLOMIX™ + Xcite™	20.25, 20.50 or 17A, 20.25F, 20.50F pumps + Xcite™						More than 3.9 gal/day (15 L/day)	
AIRLESS				CYCLOMIX™ or PU 3000 + M 250	EOS 30-C25, 40.25, 40.50 or 34A, 40.25F, 40.50F + M 250						More than 3.9 gal/day (15 L/day)	
ELECTRO*				PU 2125F or PU 2160 or CYCLOMIX™ or PU 3000 + KMV3*, KMP3* KMX3*, KMC3* Spraymium*	KMV3*, KMP3* KMX3*, KMC3* Spraymium* + pumps						More than 2.6 gal/day (10 L/day)	

* For conductive products, see electrostatic chapter

How to choose the right equipment for your application :

- 1- the type of part you are coating
- 2- your fluid consumption
- 3- the product you apply and its viscosity

RECOMMENDED EQUIPMENT FOR YOUR - METAL MANUAL APPLICATION

		SPRAYING								
Type of part	Fluids	Type Viscosity (CA4/cps)	Example	2 components solvent/water based (primer, lacquer, varnishes)	Thick adhesives water/solvent	Solvent-based adhesives	Primers, anti-rust coatings	Lacquers,	Sealers	Fluid consumption in gallons /day (liter/day)
				15'' to 90'' (up to 300)	- (300 to 10 000)	45'' to 90'' (120 to 300)		20'' to 45'' (40 to 60)	15'' to 20''	
				motor oil	liquid honey	thick motor oil		cooking oil	water	
HTI	All sorts of parts, shapes and type of metal			PU 2125 F + M22 P HTi	M22 G HTi M22 G HTi				Less than 1.3 gal/day (5 L/day)	
				PU 3000 or CYCLOMIX™ + M22 P HTi					1.3-2.6 gal/day (5 to 10 L/day)	
HPA				PU 2125 F + M22 P HPA	M22 G HPA M22 G HPA GSP				Less than 1.3 gal/day (5 L/day)	
				PU 3000 or CYCLOMIX™ + M22 P HPA					1.3-2.6 gal/day (5 to 10 L/day)	
AIRMIX®	Generally flat and plain parts : cabinets, agricultural machinery, machine tools, rolling equipment, moulded parts, panels...			PU 2160 or PU 3000 or CYCLOMIX™ + Xcite™	EOS 15-C25 or 30-C25 pump + Xcite™				1.3-3.9 gal/day (5-15 L/day)	
				PU 3000 or CYCLOMIX™ + Xcite™					More than 3.9 gal/day (15 L/day)	
AIRLESS	Generally flat parts with a large surface area: building, railways, frames,...			CYCLOMIX™ or PU 3000 + M 250	EOS 30-C25, 40.25, 40.50 or 34A, 40.25F, 40.50F pumps + M 250				More than 2.6 gal/day (10 L/day)	
ELECTRO*	Parts with tubular section - seats, cycles and motorcycles, aeronautics...			CYCLOMIX™ or PU 3000 + KMV3*, KMP3* KMX3*, KMC3* Spraymium*	KMV3*, KMP3* KMX3*, KMC3* Spraymium* + pump				More than 2.6 gal/day (10 L/day)	

* For conductive products, see electrostatic chapter

How to choose the right equipment for your application :



- 1- the type of part you are coating
- 2- your fluid consumption
- 3- the product you apply and its viscosity

RECOMMENDED EQUIPMENT FOR YOUR - PLASTIC MANUAL APPLICATION

		SPRAYING						
Type of part	Fluids	Type Viscosity (CA4/cps)	Example	2 components solvent/water based (primer, lacquer, varnishes)	Solvent-based adhesives	Primer	Clear coats, lacquers, varnishes	Fluid consumption in gallons / day (liter/day)
				15'' to 45'' (up to 20)	45'' to 90'' (120 to 300)	30'' to 45'' (30 to 120)	15'' to 30'' -	
				motor oil	thick motor oil	cooking oil	water	
HPA	Television, Hi-Fi, computer cases, household appliances, house and garden furniture, dash boards, bumpers, steering wheels, wing mirror						M22 G HTi or S3	Less than 1.3 gal/day (5 L/day)
				PU 2125F or CYCLOMIX™ + M22 P HTi		Pressure cup 2.5 quart or Pressure pot 2.5 gallon or PMP pump 150 mobile/wall-mounted or 02.75 + M22 P HTi		More than 1.3 gal/day (5 L/day)
HTI					M22 G GSP HPA		M22 G HPA M22 G HPA S3	Less than 1.3 gal/day (5 L/day)
				PU 2125F or PU 3000 or CYCLOMIX™ + M22 P HTi		Pressure cup 2.5 quart or Pressure pot 2.5 gallon or PMP pump 150 mobile/wall-mounted or 02.75 + M22 P HPA		More than 1.3 gal/day (5 L/day)
ELECTRO*			CYCLOMIX™ PU 3000 + KMV3* KMP3* Spraymium*			KMV3*, KMP3* Spraymium* + pump	More than 2.6 gal/day (10 L/day)	

* For conductive products, see electrostatic chapter

How to choose the right equipment for your application :

- 1- the type of part you are coating
- 2- your fluid consumption
- 3- the product you apply and its viscosity

AIRSPRAY EQUIPMENT



M22 G HTi

M22 SPRAY GUNS



The M22 G HTi is a gravity fed gun that delivers high finish quality and transfer efficiency with outstanding operator comfort. This gun is available with one of two aircaps: EP5 for hard to atomize coatings such as high solids and waterbornes; and an E5 K HVLP for optimizing efficiency and HVLP compliant airspray.

FEATURES	BENEFITS
New ergonomics and body design Reduced trigger pull	Reduces the potential for operator injury from long term use
Stainless steel wetted parts	Compatible with most coatings
Unique aircap design	Important product savings and environmental protection
Fine thread packing unit	Fine packing adjustment for improved sealing
Easy adjust aircap	Allows adjustment without loosening the retaining ring
Fewer components	Simplified maintenance and easy repair
2 cups available	Acetal resin white cup for water and solvent-based materials high density polyacetal (HDPE) grey cup for pre-catalyzed or polyurethane materials

SPECIFICATIONS	
Sprayed materials	Virtually all coatings
Body of the gun	Anodized forged aluminum
Maximum air inlet pressure	87 psi (6 bar)
Recommended atomization air pressure at the gun handle	EP5: 29 - 44 psi (2 - 3 bar) E5 K HVLP: 22.5 - 37.5 psi (1.5 - 2.5 bar)
Air consumption	EP5: 11.89 cfm @ 37.5 psi (20 m ³ /h @ 2.5 bar) E5 K HVLP: 16 cfm @ 30 psi (27.2 m ³ /h @ 2 bar)
Weight (with cup)	21.9 oz. (680 g)
Maximum fluid temperature	122°F (50°C)
Transfer efficiency in % (EN 13966-1)	EP5: 74% E5 K HVLP: 76%
Nozzle	Stainless steel
Needle	Stainless steel
Wetted parts	Stainless steel / Aluminum

FITTINGS	
Air inlet	M 1/4" NPS (+ M 1/4" BSP)
Fluid inlet (gravity cup)	-

AIRCAP
E5 K HVLP



NOTE: for HVLP compliance, the maximum inlet air pressure at the gun handle must not exceed 2 bar (29 psi) to maintain 10 psi or less at the air cap. Testing for HVLP compliance was performed using the specified HVLP test air cap, the fan control fully open and a pressure gauge on the Air inlet fitting at the gun base or handle. It may also be a requirement of some regulatory agencies that users have the appropriate test air cap available on site to verify that the gun is being operated within the regulatory limitations.

CONFIGURATION OF THE M22 G HTi WITH E5 KHVLP AIRCAP

Max fluid viscosity in CA 4	Projector type	Nozzle Size	Fluid flow rate	Fan width at 8 inches (20 cm)	Cup	Part number
-	-	-	-	-		
< 20 s	12 E5 K HVLP	0.047 in (1.2 mm)	4.3 oz/mn (127 cc/mn)	8.6 in (22 cm)	HDPE cup 20.2 fl.oz. (0.6 liters) grey	136-131-100
	13 E5 K HVLP	0.051 in (1.3 mm)	5.7 oz/mn (169 cc/mn)	9.8 in (25 cm)		136-131-101
	14 E5 K HVLP	0.055 in (1.4 mm)	7.3 oz/mn (216 cc/mn)	12.2 in (31 cm)		136-131-102
20 - 40 s	15 E5 K HVLP	0.059 in (1.5 mm)	8.3 oz/mn (245 cc/mn)	13.8 in (35 cm)		136-131-103
	18 E5 K HVLP	0.070 in (1.8 mm)	8.8 oz/mn (260 cc/mn)	14.4 in (36.5 cm)		136-131-104
> 40s	22 E5 K HVLP	0.086 in (2.2 mm)	9.5 oz/mn (280 cc/mn)	14.9 in (38 cm)		136-131-105
> 40 s						136-131-106

PART NUMBERS

Description	Part number
Gun, M22 HTiG, 09E5, c/w grey cup	668-131-101
Gun, M22 HTiG, 15E5, w/o cup	668-131-204
Gun, M22 HTiG, 18E5, w/o cup	668-131-205
Gun, M22 HTiG, 22EN5, c/w white cup	668-130-116
Gun, M22 HTiG, 22EN5, c/w grey cup	668-131-116

M22 G HTI

PROJECTORS FOR GRAVITY M22 G HTI E5 KHVLP

Max fluid viscosity in CA 4	Nozzle		Air consumption	Fluid flow rate	Fan width at 8 inches (20 cm)	Projector		Nozzle	Aircap	Needle
	Size					Type	Part number			
< 20 s	0.047 in (1.2 mm)	16 cfm @ 30 psi	4.3 oz/mn (127 cc/mn)	8.6 in (22 cm)	12 E5 KHVLP	031-130-001	134-130-300	132-130-100	033-130-100	
	0.051 in (1.3 mm)		5.7 oz/mn (169 cc/mn)	9.8 in (25 cm)	13 E5 KHVLP	031-130-002	134-130-400	132-130-100	033-130-100	
	0.055 in (1.4 mm)		7.3 oz/mn (216 cc/mn)	12.2 in (31 cm)	14 E5 KHVLP	031-130-003	134-130-500	132-130-100	033-130-200	
20 - 40 s	0.059 in (1.5 mm)	(27.2 m ³ /h @ 2 bar ⁽²⁾)	8.3 oz/mn (245 cc/mn)	13.8 in (35 cm)	15 E5 KHVLP	031-130-004	134-130-600	132-130-100	033-130-200	
	0.070 in (1.8 mm)		8.8 oz/mn (260 cc/mn)	14.4 in (36.5 cm)	18 E5 KHVLP	031-130-005	134-130-700	132-130-100	033-130-200	
> 40 s	0.086 in (2.2 mm)		9.5 oz/mn (280 cc/mn)	14.9 in (38 cm)	22 E5 KHVLP	031-130-006	134-130-800	132-130-100	033-130-300 ⁽¹⁾	

(1) polyacetal end needle

(2) 10 psi (0.7 bar) at the aircap - 30 psi (2 bar) at the handle



CONFIGURATION OF THE M22 G HTI WITH EP 5 AIRCAP

Max fluid viscosity in CA 4	Projector type	Nozzle		Fluid flow rate	Fan width at 8 inches (20 cm)	Cup	Part number
		Size					
-	-	-	-	-	-	HDPE 20.2 fl.oz.(0.6 liters) white	136-130-100
-	-	-	-	-	-	HDPE 20.2 fl.oz.(0.6 liters) grey	136-131-100
< 20 s	12 EP 5	0.047 in (1.2 mm)	4.7 oz/mn (139 cc/mn)	8.3 in (21 cm)	HDPE 20.2 fl.oz.(0.6 liters) white	136-130-111	
			5.9 oz/mn (174 cc/mn)	8.6 in (22 cm)	HDPE 20.2 fl.oz.(0.6 liters) grey	136-131-111	
	13 EP 5	0.051 in (1.3 mm)	7.6 oz/mn (225 cc/mn)	11 in (28 cm)	HDPE 20.2 fl.oz.(0.6 liters) white	136-130-112	
			8.6 oz/mn (254 cc/mn)	11.4 in (29 cm)	HDPE 20.2 fl.oz.(0.6 liters) grey	136-131-112	
	14 EP 5	0.055 in (1.4 mm)	9.4 oz/mn (278 cc/mn)	12 in (30.5 cm)	HDPE 20.2 fl.oz.(0.6 liters) white	136-130-113	
			9.5 oz/mn (280 cc/mn)	12.6 in (32 cm)	HDPE 20.2 fl.oz.(0.6 liters) grey	136-131-113	
20 - 40 s	15 EP 5	0.059 in (1.5 mm)	8.6 oz/mn (254 cc/mn)	11.4 in (29 cm)	HDPE 20.2 fl.oz.(0.6 liters) white	136-130-114	
			9.4 oz/mn (278 cc/mn)	12 in (30.5 cm)	HDPE 20.2 fl.oz.(0.6 liters) grey	136-131-114	
	18 EP 5	0.070 in (1.8 mm)	9.4 oz/mn (278 cc/mn)	12 in (30.5 cm)	HDPE 20.2 fl.oz.(0.6 liters) white	136-130-115	
			9.5 oz/mn (280 cc/mn)	12.6 in (32 cm)	HDPE 20.2 fl.oz.(0.6 liters) grey	136-131-115	
> 40 s	22 EP 5	0.086 in (2.2 mm)	9.5 oz/mn (280 cc/mn)	12.6 in (32 cm)	HDPE 20.2 fl.oz.(0.6 liters) white	136-130-116	
			9.5 oz/mn (280 cc/mn)	12.6 in (32 cm)	HDPE 20.2 fl.oz.(0.6 liters) grey	136-131-116	

PROJECTORS FOR GRAVITY M22 G HTI EP5

Max fluid viscosity in CA 4	Nozzle		Air consumption	Fluid flow rate	Fan width at 8 inches (20 cm)	Projector		Nozzle	Aircap	Needle
	Size					Type	Part number			
< 20 s	0.047 in (1.2 mm)	11.9 cfm @ 30 psi	141	8.3 in (21 cm)	12 EP 5	031-130-011	134-130-300	132-130-300	033-130-100	
	0.051 in (1.3 mm)		176	8.6 in (22 cm)	13 EP 5	031-130-012	134-130-400	132-130-300	033-130-100	
	0.055 in (1.4 mm)		225	11 in (28 cm)	14 EP 5	031-130-013	134-130-500	132-130-300	033-130-200	
20 - 40 s	0.059 in (1.5 mm)	(20.2 m ³ /h @ 2 bar ⁽²⁾)	255	11.4 in (29 cm)	15 EP 5	031-130-014	134-130-600	132-130-300	033-130-200	
	0.070 in (1.8 mm)		278	12 in (30.5 cm)	18 EP 5	031-130-015	134-130-700	132-130-300	033-130-200	
> 40 s	0.086 in (2.2 mm)		280	12.6 in (32 cm)	22 EP 5	031-130-016	134-130-800	132-130-300	033-130-300 ⁽¹⁾	

(1) polyacetal end needle

(2) 10 psi (0.7 bar) at the aircap - 30 psi (2 bar) at the handle

MAINTENANCE KITS

Description	Part number
Seal kit	129-130-901
Repair kit (includes the seal kit)	129-130-902

M22 G HPA



The M22 G HPA is a gravity gun that delivers outstanding finish quality with unsurpassed operator comfort. Recommended for hard to atomize coatings.

FEATURES	BENEFITS
New ergonomics and body design	Allows the operator to focus on the application and the spraying movement for improved quality
Stainless steel wetted parts	Compatible with water-based products, etc...
Unique aircap design	Perfectly balanced fan provides unsurpassed finish quality
Fine thread packing unit	Fine packing adjustment for improved sealing
E-Z adjust aircap	Allows adjustment without loosening the retaining ring
Reduced number of components	Easy maintenance
Choice of two 20 oz. (0.6 L) cups available	HDPE grey cup for pre catalyzed or polyurethane materials. Optional - Polyacetal white cup for water and solvent-based materials

SPECIFICATIONS	
Sprayed materials	Varnishes, lacquers, stains, Polyurethanes, two-component
Body of the gun	Anodized forged aluminum
Maximum air inlet pressure	87 psi (6 bar)
Recommended atomization air pressure	27-58 psi (2 - 4 bar)
Air consumption	15.6 cfm (26.5 m ³ /h)
Weight (with cup)	21.9 oz (680 g)
Maximum fluid temperature	122°F (50°C)
Transfer efficiency in % (EN 13966-1)	65%
Nozzle	Stainless steel
Needle	Stainless steel
Wetted parts	Stainless steel

FITTINGS	
Air inlet	M 1/4" NPS (+ M 1/4" BSP)
Fluid inlet (gravity cup)	-

AIRCAP
EN5







CONFIGURATION OF THE M22 G HPA GRAVITY

Max fluid viscosity in CA 4	Projector type	Nozzle	Fluid flow rate	Fan width at 8 inches (20 cm)	Cup	Part number
		Size				
-	-	-	-	-	-	
< 20 s	12 EN5	0.047 in (1.2 mm)	4.6 oz/mn (136 cc/mn)	8.5 in (21.5 cm)	HDPE cup 20.2 fl.oz. (0.6 liters) grey	136-136-100
	13 EN5	0.051 in (1.3 mm)	5.8 oz/mn (172 cc/mn)	9.3 in (23.5 cm)		136-136-101
	14 EN5	0.055 in (1.4 mm)	7.9 oz/mn (234 cc/mn)	10.8 in (27.5 cm)		136-136-102
	15 EN5	0.059 in (1.5 mm)	8.6 oz/mn (256 cc/mn)	11.8 in (30 cm)		136-136-103
20 - 40 s	18 EN5	0.070 in (1.8 mm)	9.5 oz/mn (280 cc/mn)	12.2 in (31 cm)		136-136-104
	22 EN5	0.086 in (2.2 mm)	10.1 oz/mn (300 cc/mn)	12.6 in (32 cm)		136-136-105
> 40 s	-	-	-	-	136-136-106	

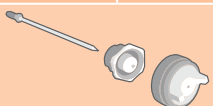

M22 G HPA

PROJECTORS FOR M22 G HPA SPRAY GUNS

Max fluid viscosity in CA 4	Nozzle Size	Air consumption	Fluid flow rate	Fan width at 8 inches 20 cm	Projector		Nozzle	Aircap	Needle
					Type	Part number			
									
< 20 s	0.047 in (1.2 mm)	15.6 cfm (26.5 m³/h)	4.6 oz/mn (136 cc/mn)	8.5 in (21.5 cm)	12 EN5	031-135-001	134-130-300	132-130-200	033-130-100
< 20 s	0.051 in (1.3 mm)		5.8 oz/mn (172 cc/mn)	9.3 in (23.5 cm)	13 EN5	031-135-002	134-130-400	132-130-200	033-130-100
< 20 s	0.055 in (1.4 mm)		7.9 oz/mn (234 cc/mn)	10.8 in (27.5 cm)	14 EN5	031-135-003	134-130-500	132-130-200	033-130-200
20 - 40 s	0.059 in (1.5 mm)		8.6 oz/mn (254 cc/mn)	11.8 in (30 cm)	15 EN5	031-135-004	134-130-600	132-130-200	033-130-200
20 - 40 s	0.070 in (1.8 mm)		9.5 oz/mn (280 cc/mn)	12.2 in (31 cm)	18 EN5	031-135-005	134-130-700	132-130-200	033-130-200
> 40 s	0.086 in (2.2 mm)		10.1 oz/mn (300 cc/mn)	12.6 in (32 cm)	22 EN5	031-135-006	134-130-800	132-130-200	033-130-300 ⁽¹⁾

(1) polyacetal end needle

SEAL KITS

Description	Part number
Seal kit	129-130-901
Repair kit (includes the seal kit)	129-130-902

■ Needle with polyacetal end for M22 G

NEEDLE WITH POLYACETAL END FOR M22 G HTI AND HPA (OPTIONAL)

Description	Nozzle Size	Part number
		
Needle with polyacetal end	0.027 in (0.7 mm) 0.035 in (0.9 mm) 0.047 in (1.2 mm) 0.051 in (1.3 mm)	033-130-400
Needle with polyacetal end	0.055 in (1.4 mm) 0.06 in (1.5 mm) 0.07 in (1.8 mm)	033-130-500

PART NUMBERS

Description	Part number
M22 HPAG, 15EG1, c/w grey cup - Glue setup	668-136-024
M22 HPAG, 22EP5, c/w grey cup - Glue setup	668-136-106

LACQUERS, STAINS, VARNISHES

SPRAY GUNS M22 G HPA

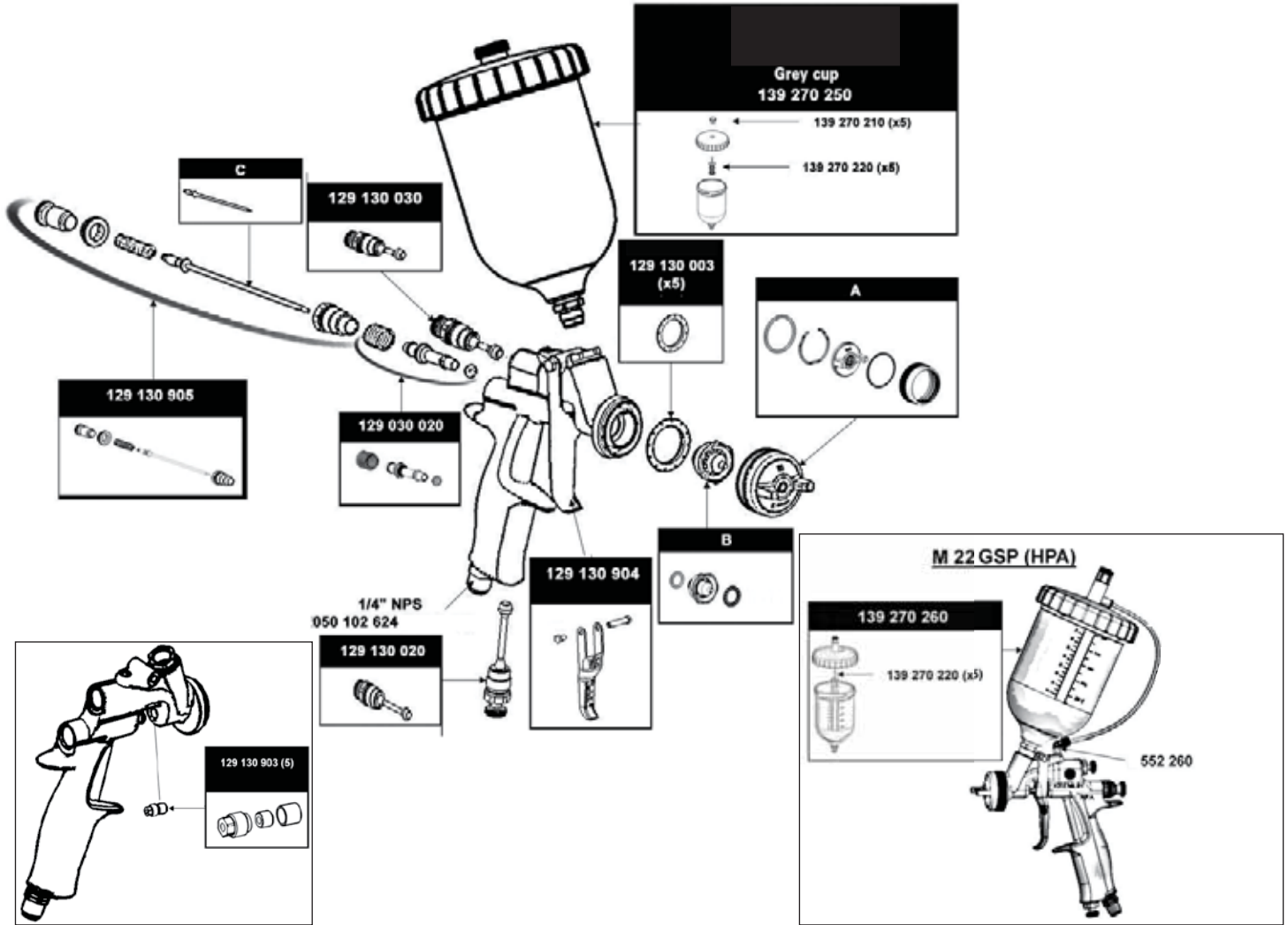

SERVICE KITS



AIR HOSE AND ACCESSORIES

Description		Part number		
Air hose with 1/4" NPS fittings		905-030-105		
Description	Type of gun	Diameter	Length	Part number
Air hose with 1/4" NPS fittings	M22/S3 HPA	1/4" (7 mm)	25' (7.5 m)	050-382-114
			32' (10 m)	050-382-110
	M22 HTI K HVLP	5/16" (8 mm)	25' (7.5 m)	050-389-103
			32' (10 m)	050-389-102



M22 G BASIK HPA

M22 SPRAY GUNS



The M22 G Basik HPA is an economy gun with our unsurpassed ergonomic gun body. It is recommended for low-volume applications requiring good atomization.

FEATURES	BENEFITS
Polished aluminum body	Easy and quick maintenance
Stainless steel wetted parts	Compatible with most materials
New design of the BA aircap	Spraying quality guaranteed
E-Z adjust aircap	Allows adjustment without loosening the retaining ring
Polyacetal cup 20 oz (0.6 L)	Can be quickly cleaned

SPECIFICATIONS	
Sprayed materials	Varnishes, lacquers, stains, Polyurethanes, two-component
Body of the gun	Polished forged aluminum
Maximum air inlet pressure	87 psi (6 bar)
Recommended atomization air pressure	29 psi (2 bar)
Air consumption	16.5 cfm (28 m ³ /h)
Weight (with cup)	22.2 oz (690 g)
Maximum fluid temperature	122°F (50°C)
Transfer efficiency in % (EN 13966-1)	65
Nozzle	Stainless steel
Needle	Stainless steel
Wetted parts	Stainless steel/Aluminum

FITTINGS	
Air inlet	M 1/4" NPS (+ M 1/4" BSP)
Fluid inlet (gravity cup)	-



CONFIGURATION OF THE M22 G BASIK HPA

Max fluid viscosity in CA 4	Projector type	Nozzle	Fluid flow rate	Fan width at 8 inches (20 cm)	Cup	Part number
		Size				
-	-	-	-	-	Polyacetal 0.6L (white)	136-137-100
20 - 40 s	18 BA5	0.07 in (1.8 mm)	9.4 oz/mn (278 cc/mn)	12.2 in (31 cm)	Polyacetal 0.6L (white)	136-137-110

PROJECTORS FOR M22 G BASIK HPA

Max fluid viscosity in CA 4	Nozzle	Air consumption	Fluid flow rate	Fan width at 8 inches (20 cm)	Projector		Nozzle	Aircap	Needle
	Size				Type	Part number			
20-40	0.07 in (1.8 mm)	16.5 cfm (28 m ³ /h)	9.4 oz/mn (278 cc/mn)	12.2 in (31 cm)	18 BA 5	031-137-010	134-130-700	132-137-300	033-130-200
< 20 s	0.027 in (0.7 mm)		6.7 oz/mn (200 cc/mn)						Must purchase separately
	0.035 in (0.9 mm)		8.4 oz/mn (250 cc/mn)		134-130-200	033-130-100			
	0.047 in (1.2 mm)		10.1 oz/mn (300 cc/mn)		134-130-300	033-130-100			
20 - 40 s	0.059 in (1.5 mm)		11.8 oz/mn (350 cc/mn)		134-130-600	033-130-200			

PART NUMBERS

Description	Part number
M22 G Basik, 06 BA5	668-137-101
M22 G Basik, 07 BA5	668-137-102
M22 G Basik, 09 BA5	668-137-103
M22 G Basik, 12 BA5	668-137-104
M22 G Basik, 13 BA5	668-137-105
M22 G Basik, 14 BA5	668-137-106
M22 G Basik, 15 BA5	668-137-107

SEAL KITS

Description	Part number
Seal kit	129-130-901
Repair kit (includes the seal kit)	129-130-902

LACQUERS, STAINS, VARNISHES

SPRAY GUNS M22 G BASIK HPA - SMALL QUANTITIES (1L)

M22 G BASIK HPA

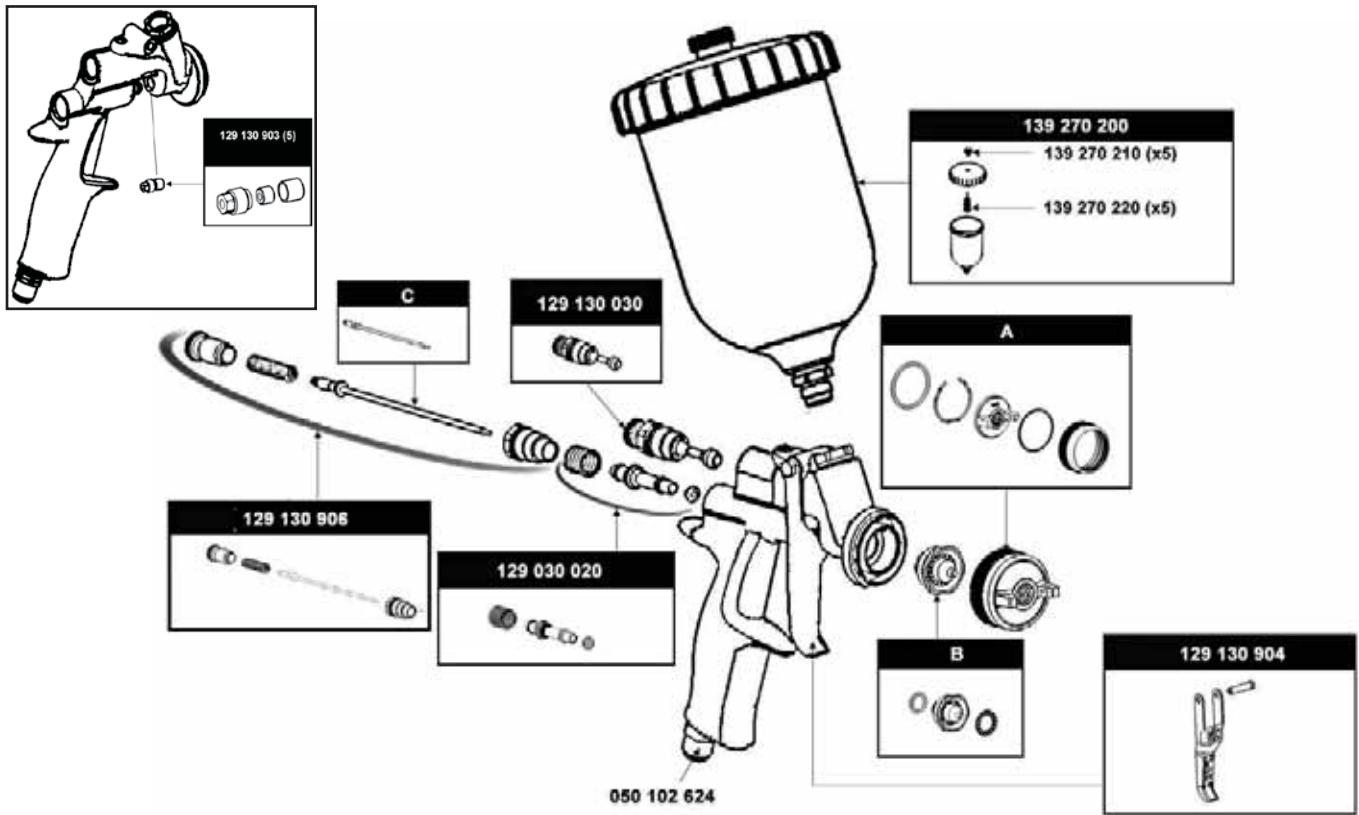

■ Gun cleaning kit

PART NUMBERS

Description	Part number
1/4 in (6.4 mm) nylon brush	668-000-395
Gun lubricant	
Tip cleaning needles	
Cleaning needle pin vise	
Contains all necessary items for spray gun maintenance	



■ Lid, liner, cup & collar

PPS 650 S3 & M22 - GRAVITY AND SUCTION GUN LID, LINER CUP & COLLAR

Lid, Liner, Cup & Collar	Part number
Includes 50 lids/liners, 2 cups & collars & adaptor	
M22 Suction	668-000-300
S3 Suction	668-000-301
M22 / S3 Suction	668-000-302
Shop Package - PPS Starter Kit	
Includes 50 lids/liners	
Dispenser for liners	668-000-298
Dispenser for lids	
REFILLS	
PPS 650 ml lids and liners - Qty 50	668-000-241
ACCESSORIES	
Wash bottle	668-000-297
Film 650 - 10 pack	668-000-269



M22 G HPA GSP



The M22 HPA GSP has our outstanding ergonomic gun body design with a unique combination pressure/gravity cup for hard to atomize coatings such as high solids and water-borne materials.

FEATURES	BENEFITS
New ergonomics and body design Reduced trigger pull effort	The operator can focus on the spraying and applying the material, not the weight and stress of the gun and cup on their body
Pressure cup fitted with a safety valve set at 7.5 psi (0.5 bar)	Full security during application : cup pressure will never exceed 7.5 psi (0.5 bar)
Improved design : the cup is under pressure during application	Full operator safety
Stainless steel wetted parts	Compatible with high viscosity materials (water based products, etc...)
Unique aircap design	Unsurpassed finish quality with perfectly balanced fan
Fine thread packing unit	Fine packing adjustment for improved sealing
E-Z adjust aircap	Allows adjustment without loosening the retaining ring
Reduced number of components	Easy maintenance

SPECIFICATIONS	
Sprayed materials	Varnishes, lacquers, stains, Polyurethanes, two component
Body of the gun	Anodized forged aluminum
Maximum air inlet pressure	87 psi (6 bar)
Recommended atomization air pressure	27-58 psi (2 - 4 bar)
Maximum cup air pressure	7.2 psi (0.5 bar)
Air consumption	16.5 cfm (26.5 m³/h)
Weight (with cup)	23 oz (710 g)
Maximum fluid temperature	122°F (50°C)
Transfer efficiency in % (EN 13966-1)	65%
Nozzle	Stainless steel
Needle	Stainless steel
Wetted parts	Stainless steel

FITTINGS	
Air inlet	M 1/4" NPS (+ M 1/4" BSP)
Fluid inlet (gravity cup - under pressure)	-







AIRCAPS EN5

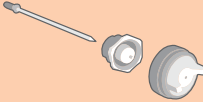

CONFIGURATION OF THE M22 G HPA GSP

Fluid viscosity	Projector type	Nozzle	Fan width at 8 inches (20 cm)	Cup	Part number
		Size			
< 3000 cps	15 EN5	0.059 in (1.5 mm)	11.8 in (30 mm)	HDPE 20.6 fl. oz. (0.6L) (grey)	 136-138-104
	18 EN5	0.070 in (1.8 mm)	12.2 in (31 mm)		136-138-105
	22 EN5	0.086 in (2.2 mm)	12.6 in (32 mm)		136-138-106

PROJECTORS FOR M22 G HPA GSP SPRAY GUNS

Max fluid viscosity in CA 4	Nozzle	Air consumption	Fan width at 8 inches (20 cm)	Projector		Nozzle	Aircap	Needle				
	Size			Type	Part number							
20 - 40 s	0.059 in (1.5 mm)	16.5 cfm (26.5 m³/h)	11.8 in (30 mm)		15 EN5	031-135-004				134-130-600	132-130-200	033-130-200
20 - 40 s	0.070 in (1.8 mm)		12.2 in (31 mm)	18 EN5	031-135-005	134-130-700	132-130-200	033-130-200				
> 40 s	0.086 in (2.2 mm)		12.6 in (32 mm)	22 EN5	031-135-006	134-130-800	132-130-200	033-130-300 ⁽¹⁾				

(1) polyacetal end needle

SEAL KITS

Description	Part number
Seal kit	129-130-901
Repair kit (includes the seal kit)	129-130-902

M22 P HTi

M22 SPRAY GUNS



The M22 P HTi gun delivers high finish quality and transfer efficiency with outstanding operator comfort. Available with one of two aircaps; EP3, for hard to atomize coatings such as high solids and waterbornes or E3 K HVLP, our highest efficiency and HVLP compliant aircap.

FEATURES	BENEFITS
New ergonomics and body design Reduced trigger pull effort	Reduces the potential for operator injury from long term use
Stainless steel wetted parts	Compatible with water-based materials, etc...
Unique aircap design	Unsurpassed finish quality with perfectly balanced fan
High transfer efficiency	Important product savings and environmental protection
Fine thread packing unit	Fine packing adjustment for improved sealing
E-Z adjust aircap	Allows adjustment without loosening the retaining ring
Reduced number of components	Easy maintenance

SPECIFICATIONS	
Sprayed materials	Varnishes, lacquers, stains, Polyurethanes, two-component
Body of the gun	Anodized forged aluminum
Maximum air inlet pressure	87 psi (6 bar)
Recommended atomization air pressure	21 - 36 psi (1.5 - 2.5 bar)
Maximum fluid pressure	87 psi (6 bar)
Air consumption	EP3: 11.9 - 17.1 cfm (20.2 - 29 m ³ /h) E3 K HVLP: 13.5 - 19.4 cfm (23 - 33 ⁽¹⁾ m ³ /h)
Weight	16.7 oz (520 g)
Maximum fluid temperature	122°F (50°C)
Transfer efficiency in % (EN 13966-1)	EP3: 72% E3 K HVLP: 75%
Nozzle	Stainless steel
Needle	Treated stainless steel
Wetted parts	Stainless steel

(1) 10 psi (0.7 bar) at the aircap - 29 psi (2 bar) at the handle



NOTE: for HVLP compliance, the maximum inlet air pressure at the gun handle must not exceed 2 bar (29 psi) to maintain 10 psi or less at the air cap. Testing for HVLP compliance was performed using the specified HVLP test air cap, the fan control fully open and a pressure gauge on the Air inlet fitting at the gun base or handle. It may also be a requirement of some regulatory agencies that users have the appropriate test air cap available on site to verify that the gun is being operated within the regulatory limitations.

AIRCAP
E3 K HVLP





CONFIGURATION OF THE M22 P HTi WITH E 3 K HVLP AIRCAP

Max fluid viscosity in CA 4	Projector type	Nozzle	Fluid flow rate	Fan width at 8 inches (20 cm)	Part number
		Size			
-	-	-	-	-	135-140-200
< 20 s	07 E3 K HVLP	0.027 in (0.7 mm)	6.7 oz/mn (200 cc/mn)	12.8 in (32.5 cm)	135-140-201
	09 E3 K HVLP	0.035 in (0.9 mm)	8.4 oz/mn (250 cc/mn)	14.9 in (38 cm)	135-140-202
	12 E3 K HVLP	0.047 in (1.2 mm)	10.1 oz/mn (300 cc/mn)	16.5 in (42 cm)	135-140-203
20 - 40 s	15 E3 K HVLP	0.059 in (1.5 mm)	11.8 oz/mn (350 cc/mn)	18.1 in (46 cm)	135-140-206
	18 E3 K HVLP	0.071 in (1.8 mm)	13.5 oz/mn (400 cc/mn)	18.9 in (48 cm)	135-140-207

PART NUMBERS

Description	Part number	Description	Part number
M22 HTiP, 18ER1	668-140-237	M22 HTiA, 15E5, w/o cup	668-140-106
M22 HTiP, 22E3	668-140-221	M22 HTiA, 18E5, c/w cup	668-140-207
M22 HTiP, 22EP3	668-140-222	M22 HTiA, 18E5, w/o cup	668-140-107
M22 HTiP, 22ES3	668-140-223	M22 HTiA, 18E5, w/o cup	668-140-227
		M22 HTiA, 18EP5, c/w cup	668-140-217
		M22 HTiA, 22E5, w/o cup	668-140-109

PROJECTORS FOR PRESSURE M22 HTI E3 KHVLP

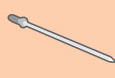

Max fluid viscosity in CA 4	Nozzle		Air consumption	Fluid flow rate	Fan width at 8 inches (20 cm)	Projector		Nozzle	Aircap	Treated needle
	Size					Type	Part number			
										
< 20 s	0.027 in (0.7 mm)		13.5 cfm (23 m³/h)	6.7 oz/mn (200 cc/mn)	12.7 in (32.5 cm)	07 E3 KHVLP	031-140-001	134-130-100	132-140-100	033-140-100
	0.035 in (0.9 mm)		15.3 cfm (26 m³/h)	8.4 oz/mn (250 cc/mn)	14.9 in (38 cm)	09 E3 KHVLP	031-140-002	134-130-200	132-140-100	033-140-100
	0.047 in (1.2 mm)		16.5 cfm (28 m³/h)	10.1 oz/mn (300 cc/mn)	16.5 in (42 cm)	12 E3 KHVLP	031-140-003	134-130-300	132-140-100	033-140-100
20 - 40 s	0.059 in (1.5 mm)		18.2 cfm (31 m³/h)	11.8 oz/mn (350 cc/mn)	18.1 in (46 cm)	15 E3 KHVLP	031-140-006	134-130-600	132-140-100	033-140-200
	0.071 in (1.8 mm)		19.4 cfm (33 m³/h)	13.5 oz/mn (400 cc/mn)	18.9 in (48 cm)	18 E3 KHVLP	031-140-007	134-130-700	132-140-100	033-140-200

AIRCAP EP 3 

CONFIGURATION OF THE M22 P HTI WITH EP 3 AIRCAP

Max fluid viscosity in CA 4	Projector type	Nozzle		Fluid flow rate	Fan width at 8 inches (20 cm)	Part number
		Size				
-	-	-	-	-	-	135-140-200
< 20 s	07 EP 3	0.027 in (0.7 mm)		6.7 oz/mn (200 cc/mn)	11.2 in (28.5 cm)	135-140-211
	09 EP 3	0.035 in (0.9 mm)		8.4 oz/mn (250 cc/mn)	13.4 in (34 cm)	135-140-212
	12 EP 3	0.047 in (1.2 mm)		10.1 oz/mn (300 cc/mn)	14.6 in (37 cm)	135-140-213
20 - 40 s	15 EP 3	0.059 in (1.5 mm)		11.8 oz/mn (350 cc/mn)	15.3 in (39 cm)	135-140-216
	18 EP 3	0.071 in (1.8 mm)		13.5 oz/mn (400 cc/mn)	16.5 in (42 cm)	135-140-217

PROJECTORS FOR PRESSURE M22 HTI EP3

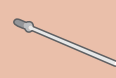
Max fluid viscosity in CA 4	Nozzle		Air consumption	Fluid flow rate	Fan width at 8 inches (20 cm)	Projector		Nozzle	Aircap	Treated needle
	Size					Type	Part number			
										
< 20 s	0.027 in (0.7 mm)		11.9 cfm (20.2 m³/h)	6.7 oz/mn (200 cc/mn)	11.2 in (28.5 cm)	07 EP 3	031-140-011	134-130-100	132-140-300	033-140-100
	0.035 in (0.9 mm)		13.2 cfm (22.5 m³/h)	8.4 oz/mn (250 cc/mn)	13.4 in (34 cm)	09 EP 3	031-140-012	134-130-200	132-140-300	033-140-100
	0.047 in (1.2 mm)		14.1 cfm (24 m³/h)	10.1 oz/mn (300 cc/mn)	14.6 in (37 cm)	12 EP 3	031-140-013	134-130-300	132-140-300	033-140-100
20 - 40 s	0.059 in (1.5 mm)		15.9 cfm (27 m³/h)	11.8 oz/mn (350 cc/mn)	15.3 in (39 cm)	15 EP 3	031-140-016	134-130-600	132-140-300	033-140-200
	0.071 in (1.8 mm)		17.1 cfm (29 m³/h)	13.5 oz/mn (400 cc/mn)	16.5 in (42 cm)	18 EP 3	031-140-017	134-130-700	132-140-300	033-140-200

FITTINGS

Air inlet	M 1/4" NPS
Fluid inlet	M 3/8" NPS

SEAL KITS

Description	Part number
Seal kit	129-130-901
Repair kit (includes the seal kit)	129-140-902

M22 P HPA

M22 SPRAY GUNS



The M22 P HPA uses our new gun body design for outstanding operator comfort. Designed for high-volume conventional spray applications.

FEATURES	BENEFITS
New ergonomics and body design reduces trigger effort	The operator can focus on the spraying and applying the material, not the weight and stress of the gun on their body
Stainless steel wetted parts	Compatible with water-based materials
Unique aircap design	Unsurpassed finish quality with perfectly balanced fan
Fine thread packing unit	Fine packing adjustment for improved sealing
E-Z adjust aircap	Allows adjustment without loosening the retaining ring
Fewer components	Easy maintenance

SPECIFICATIONS	
Sprayed materials	Varnishes, lacquers, stains, Polyurethanes, two-component
Body of the gun	Anodized forged aluminum
Maximum air inlet pressure	87 psi (6 bar)
Recommended atomization air pressure	21 - 36 psi (1.5 - 2.5 bar)
Maximum fluid pressure	87 psi (6 bar)
Air consumption	16.4 - 21.2 cfm (28 - 36.1 m ³ /h)
Weight	16.7 oz (520 g)
Maximum fluid temperature	122°F (50°C)
Transfer efficiency in % (EN 13966-1)	EN3: 63%
Nozzle	Stainless steel
Needle	Treated stainless steel
Wetted parts	Stainless steel

FITTINGS	
Air inlet	M 1/4" NPS
Fluid inlet	M 3/8" NPS

SEAL KITS	
Description	Part number
Seal kit	129-130-901
Repair kit (includes the seal kit)	129-140-902





CONFIGURATION OF THE M22 P HPA WITH EN3 AIRCAP

Max fluid viscosity in CA 4	Projector type	Nozzle	Fluid flow rate	Air consumption	Fan width at 8 inches (20 cm)	Part number
		Size				
-	-	-	-	-	-	135-145-200
< 20 s	07 EN 3	0.027 in (0.7 mm)	6.7 oz/mn (200 cc/mn)	16.5 cfm (28 m ³ /h)	10.8 in (27.5 cm)	135-145-201
	09 EN 3	0.035 in (0.9 mm)	8.4 oz/mn (250 cc/mn)	17.6 cfm (30 m ³ /h)	12.2 in (31 cm)	135-145-202
20 - 40 s	12 EN 3	0.047 in (1.2 mm)	10.1 oz/mn (300 cc/mn)	19.1 cfm (32.5 m ³ /h)	13.8 in (35 cm)	135-145-203
	15 EN 3	0.059 in (1.5 mm)	11.8 oz/mn (350 cc/mn)	20 cfm (34 m ³ /h)	14.1 in (36 cm)	135-145-206
	18 EN 3	0.071 in (1.8 mm)	13.5 oz/mn (400 cc/mn)	21.2 cfm (36.1 m ³ /h)	15.3 in (39 cm)	135-145-207

M22 P HPA

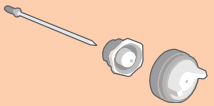
PROJECTORS FOR M22 P HPA SPRAY GUNS

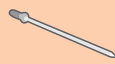
Max fluid viscosity in CA 4	Nozzle Size	Air consumption	Fluid flow rate	Fan width at 8 inches (20 cm)	Projector		Nozzle	Aircap	Treated needle
					Type	Part number			
									
< 20 s	0.027 in (0.7 mm)	16.5 cfm (28 m³/h)	6.7 oz/mn (200 cc/mn)	10.8 in (27.5 cm)	07 EN 3	031-145-001	134-130-100	132-140-200	033-140-100
< 20 s	0.035 in (0.9 mm)	17.6 cfm (30 m³/h)	8.4 oz/mn (250 cc/mn)	12.2 in (31 cm)	09 EN 3	031-145-002	134-130-200	132-140-200	033-140-100
< 20 s	0.047 in (1.2 mm)	19.1 cfm (32.5 m³/h)	10.1 oz/mn (300 cc/mn)	13.8 in (35 cm)	12 EN 3	031-145-003	134-130-300	132-140-200	033-140-100
20 - 40 s	0.059 in (1.5 mm)	20 cfm (34 m³/h)	11.8 oz/mn (350 cc/mn)	14.1 in (36 cm)	15 EN 3	031-145-006	134-130-600	132-140-200	033-140-200
	0.071 in (1.8 mm)	21.2 cfm (36.1 m³/h)	13.5 oz/mn (400 cc/mn)	15.3 in (39 cm)	18 EN 3	031-145-007	134-130-700	132-140-200	033-140-200
> 40 s	0.095 in (2.3 mm)	10.3 cfm (17.5 m³/h)	13.5 oz/mn (400 cc/mn)	14.1 in (36 cm)	23 ER 3	031-145-014	134-131-100	132-145-200	033-140-300
	0.106 in (2.7 mm)	10.5 cfm (17.9 m³/h)	16.9 oz/mn (500 cc/mn)	14.1 in (36 cm)	27 ER 3	031-145-015	134-131-200	132-145-200	033-140-300
	0.095 in (2.3 mm)	12.1 cfm (20.6 m³/h)	13.5 oz/mn (400 cc/mn)	9 in (23 cm)	23 ER 4	031-145-016	134-131-100	132-145-300	033-140-300
	0.106 in (2.7 mm)	12.3 cfm (20.9 m³/h)	18.6 oz/mn (550 cc/mn)	9 in (23 cm)	27 ER 4	031-145-017	134-131-200	132-145-300	033-140-300
	0.095 in (2.3 mm)	8 cfm (13.6 m³/h)	12.2 oz/mn (360 cc/mn)	4.7 in (12 cm)	23 ER 9	031-145-020	134-131-100	132-145-500	033-140-300
	0.106 in (2.7 mm)	8.2 cfm (13.9 m³/h)	13.5 oz/mn (400 cc/mn)	5.9 in (15 cm)	27 ER 9	031-145-021	134-131-200	132-145-500	033-140-300
> 5000 cps	0.1299 in (3.3 mm)	12.9 cfm (22 m³/h)	10.1 oz/mn (300 cc/mn)	14.1 in (36 cm)	33 ES 3	031-145-018	134-131-300	132-145-400	033-140-400 ⁽¹⁾
	0.1578 in (4.0 mm)	12.9 cfm (22 m³/h)	15.9 oz/mn (470 cc/mn)	14.1 in (36 cm)	40 ES 3	031-145-019	134-131-400	132-145-400	033-140-400
	0.1299 in (3.3 mm)	12.9 cfm (22 m³/h)	23.7 oz/mn (700 cc/mn)	4.7 in (12 cm)	33 ES 9	031-145-022	134-131-300	132-145.600	033-140-400
	0.1578 in (4.0 mm)	12.9 cfm (22 m³/h)	26.4 oz/mn (750 cc/mn)	5.9 in (15 cm)	40 ES 9	031-145-023	134-131-400	132-145.600	033-140-400



(1) polyacetal end needle

PART NUMBERS



Description	Part Number
M22 HPAP, 15EG1 - Glue setup	668-145-024
M22 HPAP, 18EG1 - Glue setup	668-145-025
M22 HPAP, 18ER3 - Glue setup	668-145-207

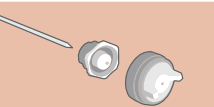

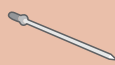
AIRCAP
EG 1

PROJECTORS FOR M22 P HPA SPRAY GUNS FOR GLUES

Max fluid viscosity in CA 4	Nozzle Size	Air consumption	Fluid flow rate	Fan width at 8 inches (20 cm)	Projector		Nozzle	Aircap	Treated needle
					Type	Part number			
									
> 30s	0.059 in (1.5 mm)	11.7 cfm (19.9 m³/h)	11.8 oz/mn (350 cc/mn)	14.1 in (36 cm)	15 EG 1	031-145-024	134-131-500	132-145-700	033-140-200
> 30s	0.071 in (1.8 mm)	11.8 cfm (20.1 m³/h)	13.5 oz/mn (400 cc/mn)	15.3 in (39 cm)	18 EG 1	031-145-025	134-131-600	132-145-700	033-140-200

■ Special needles and nozzles for M22 P

SPECIAL NEEDLES AND NOZZLES FOR M22 P			
Description	Description	Needle	Nozzle
			
207 T	Treated nozzle and needle	033-140-100	134-135-100
209 T	Treated nozzle and needle	033-140-100	134-135-200
212 T	Treated nozzle and needle	033-140-100	134-135-300
215 T	Treated nozzle and needle	033-140-200	134-135-600
218 T	Treated nozzle and needle	033-140-200	134-135-700
223 T	Treated nozzle and needle	033-140-300	134-136-100
227 T	Treated nozzle and needle	033-140-300	134-136-200
233 T	Treated nozzle and needle	033-140-400	134-136-300
240 T	Treated nozzle and needle	033-140-400	134-136-400

NEEDLE WITH POLYACETAL END FOR M22 P HTI AND HPA (OPTIONAL)		
Description	Nozzles Size	Part number
		
Polyacetal needle end	0.02 in (0.7 mm) 0.03 in (0.9 mm) 0.04 in (1.2 mm) 0.05 in (1.3 mm)	033-140-500
Polyacetal needle end	0.055 in (1.4 mm) 0.06 in (1.5 mm) 0.07 in (1.8 mm)	033-140-600

SEAL KITS	
Description	Part number
Seal kit	129-130-901
Repair kit (includes the seal kit)	129-140-902

LACQUERS, STAINS, VARNISHES

SPRAY GUNS M22 P HPA

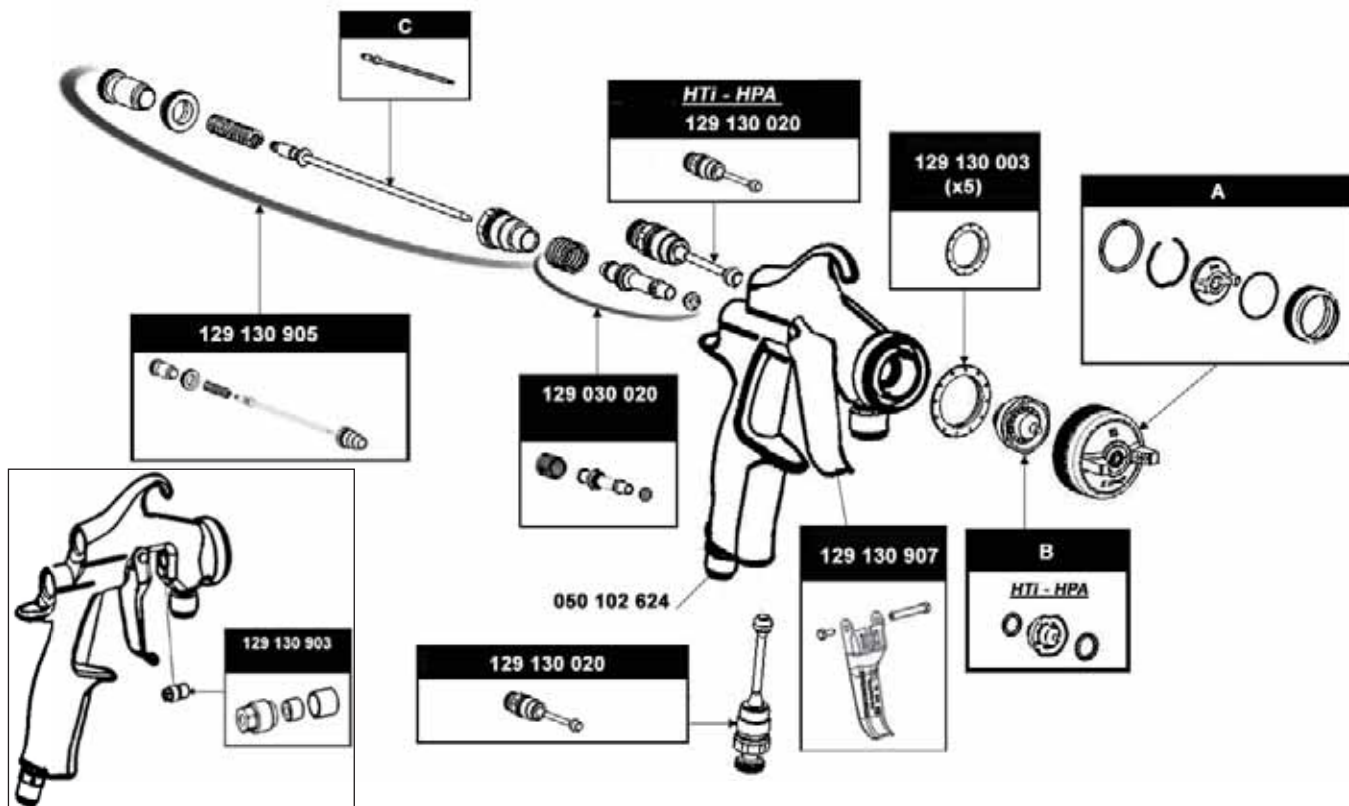

MAINTENANCE



AIR HOSE AND ACCESSORIES

Description	Gun	Diameter	Length	Part number
Air hose with 1/4" NPS fittings	M22/S3 HPA	1/4" (7 mm)	25' (7.5 m)	82-2725-25
			32' (10 m)	82-2725-32
	M22 HTI KHVLP	5/16" (8 mm)	25' (7.5 m)	050-389-103
			32' (10 m)	050-389-102

Description	Gun	Diameter	Length	Part Number
Fluid hose with 3/8" NPS fittings	M22 P HTI/HPA	1/4" (7 mm)	25' (7.5 m)	668-362-125
	M22 P HTI/HPA	1/4" (7 mm)	32' (10 m)	668-362-132



M22 P BASIK HPA



The M22 P Basic HPA is our economy conventional gun with unsurpassed ergonomics. It is designed for high-volume conventional spray applications.

FEATURES	BENEFITS
Polished aluminum body	Easy and quick maintenance
Stainless steel wetted parts	Compatible with water-based materials, etc..
E-Z adjust aircap	Allows adjustment without loosening the retaining ring
New design of the BA aircap	Spraying quality guaranteed

SPECIFICATIONS	
Sprayed materials	Varnishes, lacquers, stains, Polyurethanes, two-component
Body of the gun	Polished forged aluminum
Maximum air inlet pressure	87 psi (6 bar)
Recommended atomization air pressure	20.3 - 58 psi (1.8 - 4 bar)
Air consumption	18.2 cfm (31 m ³ /h)
Weight	18.7 oz (530 g)
Maximum fluid pressure	87 psi (6 bar)
Transfer efficiency in % (EN 13966-1)	63
Maximum fluid temperature	122°F (50°C)
Nozzle	Stainless steel
Needle	Stainless steel
Wetted parts	Stainless steel

FITTINGS	
Air inlet	M 1/4" NPS
Fluid inlet	M 3/8" NPS

SEAL KITS	
Description	Part number
Seal kit	129-130-901
Repair kit (includes the seal kit)	129-140-902



AIRCAP
BA3



CONFIGURATION OF THE M22 P BASIK HPA

Max fluid viscosity in CA 4	Projector type	Nozzle Size	Fluid flow rate	Fan width at 8 inches (20 cm)	Part number
-	-	-	-	-	 135-147-200
< 20 s	09 BA3	0.035 in (0.9 mm)	8.4 oz/mn (250 cc/mn)	12.2 in (31 cm)	135-147-205
	12 BA3	0.047 in (1.2 mm)	9.1 oz/mn (270 cc/mn)	12.6 in (32 cm)	135-147-206
	15 BA3	0.059 in (1.5 mm)	11.8 oz/mn (350 cc/mn)	14.2 in (36 cm)	135-147-207
	18 BA3	0.071 in (1.8 mm)	13.5 oz/mn (400 cc/mn)	15.3 in (39 cm)	135-147-208



M22 P BASIK HPA



PART NUMBERS

Description	Part Number
M22P Basik, 15EP3	668-147-027
M22P Basik, 09EP5	668-147-033
M22P Basik, 15EP5	668-147-037
M22P Basik, 06BA2	668-147-101
M22P Basik, 07BA2	668-147-102
M22P Basik, 09BA2	668-147-103
M22P Basik, 12BA2	668-147-104
M22P Basik, 13BA2	668-147-105
M22P Basik, 14BA2	668-147-106
M22P Basik, 15BA2	668-147-107
M22P Basik, 18BA2	668-147-108
M22P Basik, 07BA3	668-147-112
M22P Basik, 15BA3	668-147-117
M22P Basik, 18BA3	668-147-118
M22P Basik, 15EN2	668-147-137
M22P Basik, 18EN2	668-147-138
M22P Basik, 12EN3	668-147-144
M22P Basik, 15EN3	668-147-147
M22P Basik, 18EN3	668-147-148
M22P Basik, 18EG1	668-147-160
M22P Basik, 27ER1, c/w s/s needle tip	668-147-162
M22P Basik, 27ER3	668-147-164
M22P Basik, 27ER9	668-147-170
M22P Basik, 33ES9	668-147-171
M22P Basik, 22ES3	668-147-173
M22P Basik, 22ER3	668-147-174
M22P Basik, 18ER3	668-147-175

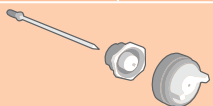
PROJECTORS FOR M22 P BASIK HPA

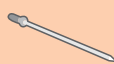
Max fluid viscosity in CA 4	Nozzle Size	Air consumption	Fluid flow rate	Fan width at 8 inches (20 cm)	Projector		Nozzle	Aircap	Needle
					Type	Part number			
									
<20 s	0.035 in (0.9 mm)	17.6 cfm (30 m³/h)	8.4 oz/mn (250 cc/mn)	12.2 in (31 cm)	09 BA 3	031-147-005	134-130-200	132-147-200	033-140-100
20-40 s	0.047 in (1.2 mm)	19.1 cfm (31 m³/h)	9.1 oz/mn (270 cc/mn)	12.6 in (32 cm)	12 BA 3	031-147-006	134-130-300	132-147-200	033-140-100
20-40 s	0.059 in (1.5 mm)	18.8 cfm (32 m³/h)	11.8 oz/mn (350 cc/mn)	14.2 in (36 cm)	15 BA 3	031-147-007	134-130-600	132-147-200	033-140-200
20-40 s	0.071 in (1.8 mm)	18.8 cfm (32 m³/h)	13.5 oz/mn (400 cc/mn)	15.3 in (39 cm)	18 BA 3	031-147-008	134-130-700	132-147-200	033-140-200

M22 P WBE HPA

M22 SPRAY GUNS



The M22 P WBE HPA uses our new gun body design for outstanding operator comfort. It delivers high-volume pressure fed conventional spraying for highly abrasive water-based coatings such as porcelain enamels.



FEATURES	BENEFITS
Stainless steel wetted parts	Compatible with water-based materials
Polyurethane needle tip and treated metal needle rod and nozzle	Wear caused by the use of abrasive products is reduced

SPECIFICATIONS	
Sprayed materials	Water-based abrasive coatings, porcelain enamels
Body of the gun	Polished forged aluminum
Maximum air inlet pressure	87 psi (6 bar)
Inlet air pressure	36.2 - 50.7 psi (2.5 - 3.5 bar)
Air consumption	10.3 - 21.2 cfm (17.5 - 36.1 m ³ /h)
Weight	16.7 oz (520 g)
Maximum fluid temperature	122°F (50°C)
Transfer efficiency in % (EN 13966-1)	63%
Nozzle	Treated metal
Needle	Treated metal
Wetted parts	Stainless steel / Polyurethane





FITTINGS	
Air inlet	M 1/4" NPS
Fluid inlet	M 3/8" NPS

AIRCAP EN3 

CONFIGURATION OF THE M22 P WBE HPA SPRAY GUN

Max fluid viscosity in CA 4	Projector type	Nozzle		Fluid flow rate	Fan width at 8 inches (20 cm)	Part number
		Size				
						
< 20s	07 EN3	0.027 in (0.7 mm)		6.7 oz/mn (200 cc/mn)	10.8 in (27.5 cm)	135-148-201
	09 EN3	0.035 in (0.9 mm)		8.4 oz/mn (250 cc/mn)	12.2 in (31 cm)	135-148-202
20 - 40s	12 EN3	0.047 in (1.2 mm)		10.1 oz/mn (300 cc/mn)	13.8 in (35 cm)	135-148-203
	15 EN3	0.059 in (1.5 mm)		11.8 oz/mn (350 cc/mn)	14.1 in (36 cm)	135-148-206
	18 EN3	0.071 in (1.8 mm)		13.5 oz/mn (400 cc/mn)	15.3 in (39 cm)	135-148-207
> 40s	23 ER3	0.091 in (2.3 mm)		13.5 oz/mn (400 cc/mn)	14.1 in (36 cm)	135-148-208

PROJECTORS FOR M22 WBE HPA SPRAY GUNS

Max fluid viscosity in CA 4	Nozzle Size	Air consumption	Fluid flow rate	Fan width at 8 inches (20 cm)	Projector		Nozzle	Aircap	Needle
					Type	Part number			
									
< 20s	0.027 in (0.7 mm)	16.4 cfm (28 m ³ /h)	6.7 oz/mn (200 cc/mn)	10.8 in (27.5 cm)	07 EN 3	031-148-001	134-135-100	132-140-200	033-148-100
< 20s	0.035 in (0.9 mm)	17.6 cfm (30 m ³ /h)	8.4 oz/mn (250 cc/mn)	12.2 in (31 cm)	09 EN 3	031-148-002	134-135-200	132-140-200	033-148-100
< 20s	0.047 in (1.2 mm)	19.1 cfm (32.5 m ³ /h)	10.1 oz/mn (300 cc/mn)	13.8 in (35 cm)	12 EN 3	031-148-003	134-135-300	132-140-200	033-148-100
20 - 40s	0.059 in (1.5 mm)	20 cfm (34 m ³ /h)	11.8 oz/mn (350 cc/mn)	14.1 in (36 cm)	15 EN 3	031-148-006	134-135-600	132-140-200	033-148-100
20 - 40s	0.071 in (1.8 mm)	21.2 cfm (36.1 m ³ /h)	13.5 oz/mn (400 cc/mn)	15.3 in (39 cm)	18 EN 3	031-148-007	134-135-700	132-140-200	033-148-100
> 40s	0.091 in (2.3 mm)	10.3 cfm (17.5 m ³ /h)	13.5 oz/mn (400 cc/mn)	14.1 in (36 cm)	23 ER 3	031-148-008	134-136-100	132-145-200	033-148-100

SEAL KITS	
Seal kit	129-130-901
Repair kit (includes the seal kit)	129-140-902
Needle tip kit for nozzles sized 7 to 23 (x10)	129-417-005

M22 P HTV

M22 SPRAY GUNS



The HTV is a pressure fed gun with outstanding ergonomics that uses Kremlin's unique Vortex technology to spray low viscosity materials on sharply profiled surfaces. Generally used as a stain gun for wood finishing.

FEATURES	BENEFITS
New ergonomics and body design	Allows the operator to focus on the application and the spraying movement for improved quality
Stainless steel product fluid passages	Compatible with most materials
Unique aircap design	Perfectly balanced fan allowing unsurpassed finish quality
High transfer efficiency	Product savings and environmental protection
Fine thread packing unit	Fine packing adjustment for improved sealing
Vortex technology	Minimizes molting and halo effects
E-Z adjust aircap	Allows adjustment without loosening the retaining ring

SPECIFICATIONS	
Sprayed materials	Varnishes / Stains
Body of the gun	Anodized forged aluminum
Maximum air inlet pressure	87 psi (6 bar)
Recommended atomization air pressure	22.5 - 37.5 psi (1.5 - 2.5 bar)
Maximum fluid pressure	87 psi (6 bar)
Air consumption	14.1 cfm (24 ³ /h) ⁽¹⁾
Weight	18.6 oz (580 g)
Maximum fluid temperature	122°F (50°C)
Transfer efficiency in % (EN 13966-1)	65 ⁽²⁾
Nozzle	Stainless steel / PEEK
Needle	Treated stainless steel
Wetted parts	Stainless steel / PEEK



NOTE: for HVLP compliance, the maximum inlet air pressure at the gun handle must not exceed 2 bar (29 psi) to maintain 10 psi or less at the air cap. Testing for HVLP compliance was performed using the specified HVLP test air cap, the fan control fully open and a pressure gauge on the Air inlet fitting at the gun base or handle. It may also be a requirement of some regulatory agencies that users have the appropriate test air cap available on site to verify that the gun is being operated within the regulatory limitations.

(1) (0,7 bar at the aircap - 2 bar at the handle)
(2) with 22-06 nozzle



FITTINGS	
Air inlet	M 1/4" NPS
Fluid inlet	M 3/8" NPS

CONFIGURATION OF THE M22 P HTV GUN WITH EV3 K HVLP AIRCAP

Max fluid viscosity in CA 4	Projector type	Nozzle		Fluid flow rate	Fan width at 8 inches (20 cm)	Part number
		Size				
14 - 20s	* 18-04 EV3 K HVLP	0.01 in (0.4 mm)		3.4 oz/mn (100 cc/mn)	9.8 in (25 cm)	135-142-201
20 - 30s	* 18-05 EV3 K HVLP	0.02 in (0.5 mm)		8.1 oz/mn (240 cc/mn)	10.8 in (27.5 cm)	135-142-202
30 -40s	* 22-06 EV3 K HVLP	0.023 (0.6 mm)		10.8 oz/mn (320 cc/mn)	11.8 in (30 cm)	135-142-203
14 - 20s	18-04 Helicoil	0.01 in (0.4 mm)		3.4 oz/mn (100 cc/mn)	9.8 in (25 cm)	134-142-102
20 - 30s	18-05 Helicoil	0.02 in (0.5 mm)		8.1 oz/mn (240 cc/mn)	10.8 in (27.5 cm)	134-142-202
30 -40s	22-06 Helicoil	0.023 (0.6 mm)		10.8 oz/mn (320 cc/mn)	11.8 in (30 cm)	134-142-302

* Nozzle sizes are related to the helicoil

PART NUMBERS

Description	Part number
M22 HTVP, 18/04 EV3 c/w inline filter	668-142-201
M22 HTVP, 18/05 EV3, c/w inline filter	668-142-202
M22 HTVP, 22/06 EV3, c/w inline filter	668-142-203

PROJECTORS FOR M22 P HTV SPRAY GUNS

Max fluid viscosity in CA 4	Nozzles		Air consumption	Fluid flow rate	Nozzle assembly	Aircap	Treated needle
	Size	Fan width at 8 inches (20 cm)					
14-20 s	18-04	9.8 in (25 cm)	14.1 cfm (24 m ³ /h)	3.4 oz/mn (100 cc/mn)	134-142-100	132-142-100	033-142-100
20-30 s	18-05	10.8 in (27.5 cm)		8.1 oz/mn (240 cc/mn)	134-142-200	132-142-100	033-142-100
30-40 s	22-06	11.58 in (30 cm)		10.8 oz/mn (320 cc/mn)	134-142.300	132-142-100	033-142-100

M22 A HPA

M22 SPRAY GUNS



The M22 A HPA is a suction fed conventional gun designed for (hard to atomize coatings).

FEATURES	BENEFITS
New ergonomics and body design	The operator can focus on the spraying and applying the material
Unique aircap design	Unsurpassed finish quality with perfectly balanced fan
Fine thread packing unit	Fine packing adjustment for improved sealing
E-Z adjust aircap	Allows adjustment without loosening the retaining ring
Fewer components	Easy maintenance

SPECIFICATIONS	
Sprayed materials	Low to medium viscosities
Body of the gun	Anodized forged aluminum
Maximum air inlet pressure	87 psi (6 bar)
Recommended atomization air pressure	29 - 43 psi (2 - 3 bar)
Air consumption	13.5 - 17.5 cfm (23 - 29.7 m ³ /h)
Weight (with cup)	32 oz (980 g)
Maximum fluid temperature	122°F (50°C)
Transfer efficiency in % (EN 13966-1)	62 %
Nozzle	Stainless steel
Needle	Stainless steel
Wetted parts	Stainless steel/aluminum

FITTINGS	
Air inlet	M 1/4" NPS (+ M 1/4" BSP)
Fluid inlet (SM6 suction cup 1L)	M 3/8" NPS

SEAL KITS	
Description	Part number
Seal kit	129-130-901
Repair kit (includes the seal kit)	129-140-902



CONFIGURATION OF THE M22 A HPA

Max fluid viscosity in CA 4	Projector type	Nozzle		Fluid flow rate	Fan width at 8 inches (20 cm)	Cup	Part number
		Size					
-	-	-		-	-	SM6 33.8 oz (1 L)	136-145-200
< 20 s	12 EN 2	0.047 in (1.2 mm)		3.38 oz/mn (100 cc/mn)	6.3 in (16 cm)		136-145-211
20 - 40 s	15 EN 2	0.059 in (1.5 mm)		7.54 oz/mn (223 cc/mn)	10.4 in (26.5 cm)		136-145-212
	18 EN 2	0.070 in (1.8 mm)		9.13 oz/mn (270 cc/mn)	10.6 in (27 cm)	Aluminum 136-145-213	

PROJECTORS FOR SUCTION-FED M22 A HPA GUNS

Max fluid viscosity in CA 4	Nozzle Size	Air consumption	Fluid flow rate	Fan width at 8 inches (20 cm)	Projector		Nozzle	Aircap	Treated needle
					Type	Part number			
< 20 s	0.047 in (1.2 mm)	13.5 cfm (23 m ³ /h)	3.4 oz/mn (100 cc/mn)	6.3 in (16 cm)	12 EN 2	031-145-011	134-130-300	132-145-100	033-140-100
20 - 40 s	0.059 in (1.5 mm)	15.9 cfm (27 m ³ /h)	7.5 oz/mn (223 cc/mn)	10.4 in (26.5 cm)	15 EN 2	031-145-012	134-130-600	132-145-100	033-140-200
	0.070 in (1.8 mm)	17.5 cfm (29.7 m ³ /h)	9.1 oz/mn (270 cc/mn)	10.6 in (27 cm)	18 EN 2	031-145-013	134-130-700	132-145-100	033-140-200
> 40 s	0.09 in (2.3 mm)	11.2 cfm (19 m ³ /h)	10.8 oz/mn (320 cc/mn)	11.8 in (30 cm)	23 ER 1	031-145-030	134-131-100	132-145-800	033-140-300
	0.10 in (2.7 mm)	11.8 cfm (20 m ³ /h)	11.5 oz/mn (340 cc/mn)	12.6 in (32 cm)	27 ER 1	031-145-031	134-131-200	132-145-800	033-140-300

PART NUMBERS

Description	Part Number	Description	Part Number
M22 A HPA, 12EN2, w/o cup	668-145-211	M22 A HPA, 22EN2, w/o cup	668-145-214
M22 A HPA, 15EN2, w/o cup	668-145-212	M22 A HPA, 23ER1, c/w SM6	668-145-800
M22 A HPA, 18EN2, w/o cup	668-145-213		

LACQUERS, STAINS, VARNISHES

SPRAY GUNS M22 A HPA

Max fluid viscosity in CA 4	Projector type	Cup	Nozzle size	Fluid flow rate	Air consumption	Fan width at 8 inches	Part number
<20 s	12 EN 2	SM6 33.8 oz (1 L)	0.047 in (1.2 mm)	3.38 fl. oz. (100 cc/mn)	13.5 cfm (23 m³/h)	6.3 in (16 cm)	136-145-211
20-40 s	15 EN 2		0.059 in (1.5 mm)	7.54 fl.oz. (223 cc/mn)	15.9 cfm (27 m³/h)	10.2 in (26.5 cm)	136-145-212
	18 EN 2		0.070 in (1.8 mm)	9.13 fl.oz. (270 cc/mn)	17.5 cfm (29,7 m³/h)	10.6 on (27 cm)	136-145-213

MAINTENANCE

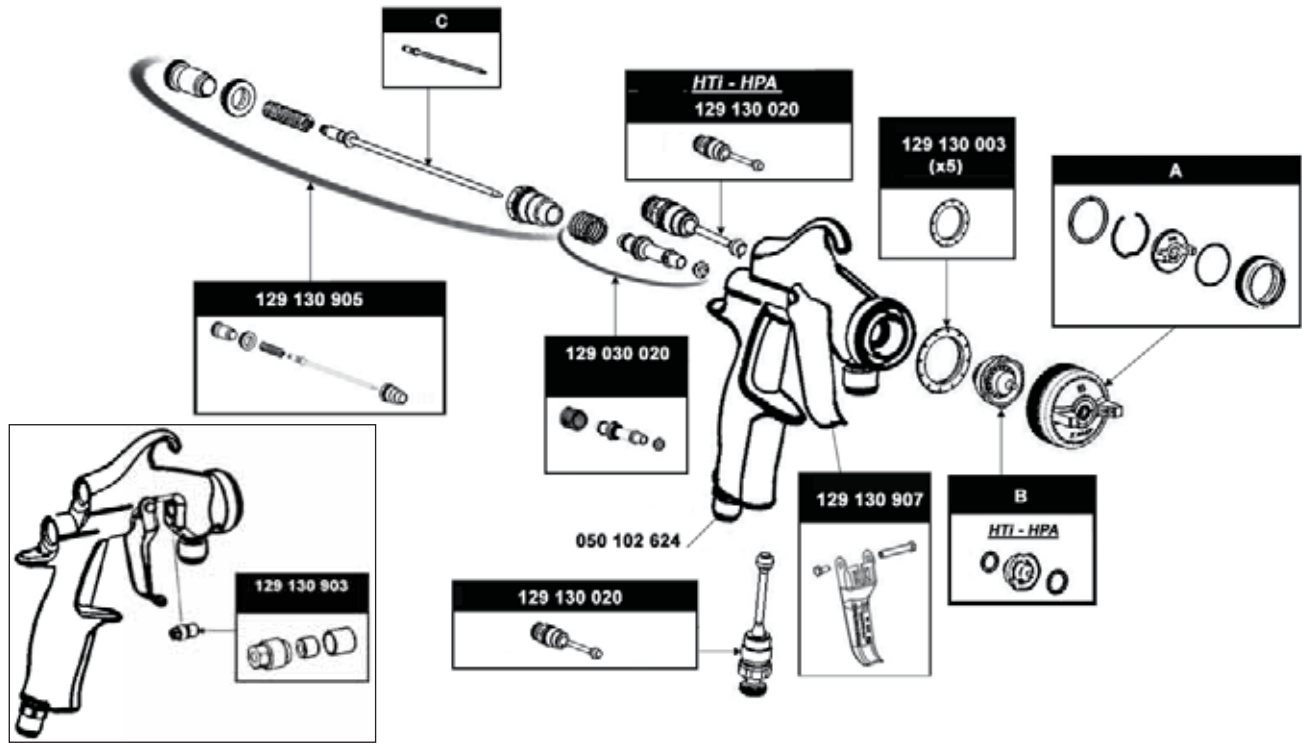

SERVICE KITS

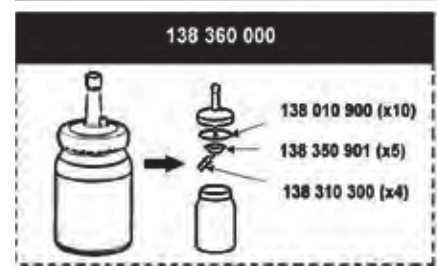

PROJECTOR KITS

Projector type	Part number	Size	Nozzle	Type	Aircap	Size	Needle
12 EN 2	031-145-011	1.2	134-130-300	EN 2	132-145-100	12	033-140-100
15 EN 2	031-145-012	1.5	134-130-600			15 - 18	033-140-200
18 EN 2	031-145-013	1.8	134-130-700				

M22 A BASIK HPA

M22 SPRAY GUNS



The M22 A Basik HPA is our economy conventional cup gun. It is designed for conventional suction fed spraying.

FEATURES	BENEFITS
Polished aluminum body	Easy and quick maintenance
E-Z adjust aircap	Allows adjustment without loosening the retaining ring
New design of the BA aircap	Spraying quality guaranteed

SPECIFICATIONS	
Sprayed materials	Virtually all coatings
Body of the gun	Polished forged aluminum
Maximum air inlet pressure	87 psi (6 bar)
Recommended atomization air pressure	36 - 50 psi (2.5 - 3.5 bar)
Air consumption	14.1 cfm (24 m ³ /h)
Weight (with cup)	32 oz (1000 g)
Transfer efficiency in % (EN 13966-1)	62
Maximum fluid temperature	122°F (50°C)
Nozzle	Stainless steel
Needle	Stainless steel
Wetted parts	Stainless steel, aluminum

FITTINGS	
Air inlet	M 1/4" NPS (+ M 1/4" BSP)
Fluid inlet	M 3/8" NPS



AIRCAP
BA2



CONFIGURATION OF THE M22 A BASIK HPA

Max fluid viscosity in CA 4	Projector type	Nozzle	Fluid flow rate	Fan width at 20 cm (cm)	Cup	Part number
		Size				
-	-	-	-	-	SM6 33.8 oz (1L)	136-147-200
20 - 40 s	15 BA2	0.059 in (1.5 mm)	7.4 oz/mn (220 cc/mn)	9.6 in (24.5 cm)	SM6 33.8 oz (1L)	136-147-201
	18 BA2	0.070 in (1.8 mm)	10.1 oz/mn (300 cc/mn)	9.8 in (25 cm)	SM6 33.8 oz (1L)	136-147-202

PROJECTORS FOR M22 A BASIK HPA

Max fluid viscosity in CA 4	Nozzle Size	Air consumption	Fluid flow rate	Fan width at 8 inches (20 cm)	Projector		Nozzle	Aircap	Needle
					Type	Part number			
20-40	0.059 in (1.5 mm)	14.1 cfm (24 m ³ /h)	7.4 oz/mn (220 cc/mn)	9.6 in (24.5 cm)		15 BA 2			
20-40	0.070 in (1.8 mm)	14.1 cfm (24 m ³ /h)	10.1 oz/mn (300 cc/mn)	9.8 in (25 cm)		18 BA 2			

SEAL KITS

Description	Part number
Seal kit	129-130-901
Repair kit (includes the seal kit)	129-140-902

LACQUERS, STAINS, VARNISHES

SPRAY GUNS M22 A BASIK HPA

MAINTENANCE - M22 A BASIK HPA

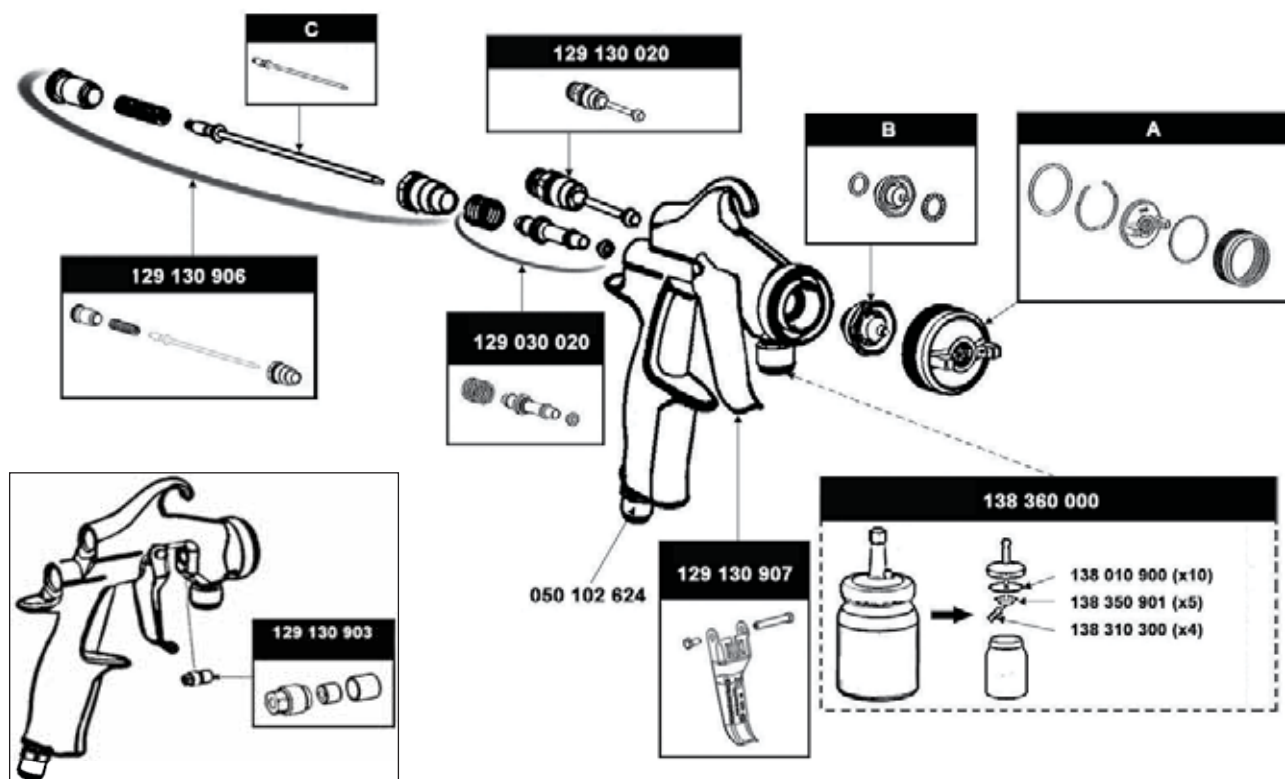

MAINTENANCE - SUCTION AND GRAVITY

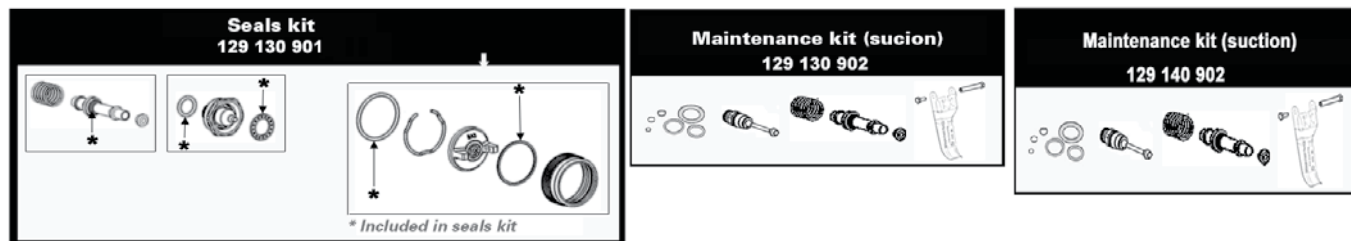



■ Aircaps for M22 airspray guns

AIRCAPS FOR HTI AND HTV AIRSPRAY GUNS

	E3 K HVLP	E5 K HVLP	EP 3	EP 5	EV 3
					
Guns	M22 P HTI	M22 G HTI	M22 P HTI	M22 G HTI	M22 P HTV
Fan shape	Flat	Flat	Flat	Flat	Flat swirling fan
Atomization Type	HTi	HTi	HTi	HTi	HTi
Atomization quality	Excellent	Excellent	Excellent	Excellent	Excellent
Transfer efficiency	76%	76%	74%	74%	65%
Air consumption @ 29 psi (2 bar)	13.5 - 19.4 cfm (23 - 33 m ³ /h)	16 psi (27.2 m ³ /h)	11.9 - 17.1 cfm (20.2 - 29 m ³ /h)	11.9 cfm (20.2 m ³ /h)	14.1 cfm (24 m ³ /h)
Nozzle size	07/18	12/22	07/18	12/22	04/06
Part number	132-140-100	132-130-100	132-140-300	132-130-100	132-142-100

AIRCAPS FOR HPA AIRSPRAY GUNS

	EN5	EN 2	EN 3
			
Guns	M22 G HPA	M22 A HPA	M22 P HPA
Fan shape	Flat	Flat	Flat
Atomization Type	HPA	HPA	HPA
Atomization quality	Very Good	Very Good	Very Good
Transfer efficiency	65%	62%	63%
Air consumption @ 29 psi (2 bar)	15.6 cfm (26.5 m ³ /h)	13.5 - 17.5 cfm (23 - 29.7 m ³ /h)	16.5 - 21.2 cfm (28 - 36.1 m ³ /h)
Nozzle size	12/22	12/18	07/18
Part number	132-130-200	132-145-100	132-140-200

AIRCAPS FOR HPA BASIK AIRSPRAY GUNS

	BA 5	BA 2	BA 3
			
Guns	M22 G Basik HPA	M22 A Basik HPA	M22 P Basik HPA
Fan shape	Flat	Flat	Flat
Atomization Type	HPA	HPA	HPA
Atomization quality	Good	Good	Good
Transfer efficiency	65%	62%	63%
Air consumption @ 29 psi (2 bar)	16.5 cfm (28 m ³ /h)	14.1 cfm (24 m ³ /h)	18.8 cfm (32 m ³ /h)
Nozzle size	18	15/18	09/12/15/18
Part number	132-137-300	132-147-100	132-147-200

AIRCAPS FOR HPA AIRSPRAY GUNS

	ER1	ER3	ER4	ER9	ES3	ES9	EG1
							
Gun Description	M22 A HPA	M22 P HPA	M22 P HPA	M22 P HPA	M22 P HPA	M22 P HPA	M22 P HPA
Fan shape	Flat	Flat	Flat	Round	Flat	Round	Flat
Atomization Type	HPA	HPA	HPA	Conventional	Conventional	Conventional	Conventional
Atomization quality	Very good	Very good	Very good	Excellent	Good	Very good	Excellent
Nozzle size	23/27	23/27	23/27	23/27	33/40	33/40	15/18
Part number	132-145-800	132-145-200	132-145-300	132-145-500	132-145-400	132-145-600	132-145-700

■ Test aircap - HVLP compliance

PART NUMBER

Fits gun series	Description	Part number
M22	E3 K HVLP aircap with test gauges	668-668-596
M22	E5 K HVLP aircap with test gauges	668-668-597



S3 G HTI



The S3 G HTI is our most compact gravity fed gun with outstanding ergonomics. Designed for small hands and tight areas where touch up or shading is required.

FEATURES	BENEFITS
New ergonomics and body design	This small, lightweight HVLP gun allows the operator to focus on the application and the spraying movement for improved quality
Reduced air consumption	Energy savings
In-line air valve assembly	Fine adjustment and long lasting components
2 different aircap kits : GAM and GL	2 types of application possible : GAM (flat fan) and GL (line spraying)
2 finger trigger	For improved application accuracy
E-Z adjust aircap	Allows aircap adjustment without loosening the retaining ring
HDPE cup	Compatible with solvent and water-based coatings

SPECIFICATIONS	
Sprayed materials	Shades, varnishes, lacquers, stains, Polyurethanes, 2 component
Body of the gun	Polished forged aluminum
Maximum air inlet pressure	87 psi (6 bar)
Recommended atomization air pressure	21 - 36 psi (1.5 - 2.5 bar)
Air consumption	4.4 cfm (7.5 ⁽¹⁾ m ³ /h)
Weight (with cup)	16.5 oz (515 g)
Maximum fluid pressure	87 psi (6 bar)
Maximum fluid temperature	122°F (50°C)
Nozzle	Stainless steel
Needle	Stainless steel
Wetted parts	Stainless steel

(1) (0,7 bar at the aircap - 2 bar at the handle)

FITTINGS	
Air inlet	M 1/4" NPS
Fluid inlet (gravity cup)	-



SEAL KITS	
Description	Part number
Seal kit	129-150-901
Repair kit (includes the seal kit)	129-150-902

CONFIGURATION OF THE S3 G HTI SPRAY GUN

Max fluid viscosity in CA 4	Projector type	Nozzle		Fluid flow rate	Fan width at 8 inches (20 cm)	Cup	Projector	
		Size					Part number	
-	-	-	-	-	-	HDPE 8.45 fl. oz. 0.25L (grey)		136-155-100
14 - 20s	08 ESG KHVLP	0.031 in (0.8 mm)		2.3 oz/mn (68 cc/mn)	5.5 in (14 cm)			136-155-112
14 - 20s	10 ESG KHVLP	0.039 in (1.0 mm)		3.4 oz/mn (100 cc/mn)	8.2 in (21 cm)			136-155-113
20 - 30s	12 ESG KHVLP	0.047 in (1.2 mm)		4.4 oz/mn (130 cc/mn)	9.4 in (24 cm)			136-155-114

PROJECTORS FOR S3 G HTI SPRAY GUNS

Max fluid viscosity in CA 4	Nozzle Size	Air consumption	Fluid flow rate	Fan width at 8 inches (20 cm)	Projector		Nozzle	Aircap	Needle
					Type	Part number			
<20 s	0.031 in (0.8 mm)	4.4 cfm (7.5 m ³ /h)	2.3 oz/mn (68 cc/mn)	5.5 in (14 cm)	08 ESG KHVLP	031-150-012	134-630-400	132-150-200	033-150-100
14 - 20s	0.039 in (1.0 mm)	4.4 cfm (7.5 m ³ /h)	3.4 oz/mn (100 cc/mn)	8.2 in (21 cm)	10 ESG KHVLP	031-150-013	134-630-100	132-150-200	033-150-500
20 - 40s	0.047 in (1.2 mm)	4.4 cfm (7.5 m ³ /h)	4.4 oz/mn (130 cc/mn)	9.4 in (24 cm)	12 ESG KHVLP	031-150-014	134-630-200	132-150-200	033-150-200

PART NUMBER

Description	Part N number
S3G, c/w cup, 12 ESG KHVLP	668-155-114
S3G, c/w cup, 15 ESG KHVLP	668-155-115

NOTE: for HVLP compliance, the maximum inlet air pressure at the gun handle must not exceed 2 bar (29 psi) to maintain 10 psi or less at the air cap. Testing for HVLP compliance was performed using the specified HVLP test air cap, the fan control fully open and a pressure gauge on the Air inlet fitting at the gun base or handle. It may also be a requirement of some regulatory agencies that users have the appropriate test air cap available on site to verify that the gun is being operated within the regulatory limitations.

S3 G HPA

S3 SPRAY GUNS



The S3 G HPA is our most compact gun designed for small hands and tight areas where touch-up is required.

FEATURES	BENEFITS
New ergonomics and body design	The operator can focus on the spraying and applying the material, not the weight and stress of the gun and cup on their body
Reduced air consumption	Energy savings
In-line air valve assembly	Fine adjustment and long lasting components
2 different projectors: AM and PGL	2 types of application possible: AM (flat fan) and PGL (special line round fan)
2 finger trigger	For an improved application accuracy
E-Z adjust aircap	Allows adjustment without loosening the retaining ring
HDPE cup	Compatible with water-based materials

SPECIFICATIONS	
Sprayed materials	Shades, varnishes, lacquers, stains, Polyurethanes, 2 component
Body of the gun	Polished forged aluminum
Maximum air inlet pressure	87 psi (6 bar)
Recommended atomization air pressure	36 - 50 psi (2.5 - 3.5 bar)
Air consumption	4.7 - 5.8 cfm (8-10 m³/h)
Weight (with cup)	16.5 oz (515 g)
Maximum fluid pressure	87 psi (6 bar)
Maximum fluid temperature	122°F (50°C)
Nozzle	Stainless steel
Needle	Stainless steel
Wetted parts	Stainless steel

FITTINGS	
Air inlet	M 1/4" NPS
Fluid inlet (gravity cup)	-



SEAL KITS	
Description	Part number
Seal kit	129-150-901
Repair kit (includes the seal kit)	129-150-902

AIRCAP
AM
PGL



CONFIGURATION OF THE S3 G HPA SPRAY GUN

Max fluid viscosity in CA 4	Projector type	Nozzle	Fluid flow rate	Fan width at 8 inches (20 cm)	Cup	Part number
		Size				
-	-	-	-	-	HDPE 20.2 fl. oz (0.25 L) (grey)	136-155-100
14-20 s	08 AM	0.031 in (0.8 mm)	2.9 oz/mn (86 cc/mn)	5.9 in (15 cm)		136-155-108
14-20 s	08 AM	0.031 in (0.8 mm)	2.9 oz/mn (86 cc/mn)	5.9 in (15 cm)		136-156-108
20-30 s	10 AM	0.039 in (1.0 mm)	4.8 oz/mn (142 cc/mn)	8.6 in (22 cm)		136-155-109
30-40 s	12 AM	0.047 in (1.2 mm)	6.1 oz/mn (180 cc/mn)	9.6 in (24.5 cm)		136-155-110
20-30 s	10 PGL	0.039 in (1.0 mm)	5.0 oz/mn (148 cc/mn)	5.1 in (13 cm)		136-155-107

PROJECTORS FOR S3G HPA SPRAY GUNS

Max fluid viscosity in CA 4	Nozzle		Air consumption	Fluid flow rate	Fan width at 8 inches (20 cm)	Projector		Nozzle	Aircap	Needle
	Size	Type				Part number				
<20 s	0.031 in (0.8 mm)	08 AM	7.5 cfm (12.9 m³/h)	2.9 oz/mn (86 cc/mn)	5.9 in (15 cm)	08 AM	031-150-008	134-630-400	132-630-400	033-150-100
	0.039 in (1.0 mm)	10 AM		4.8 oz/mn (142 cc/mn)	6.7 in (17 cm)	10 AM	031-150-009	134-630-100	132-630-400	033-150-500
	0.047 in (1.2 mm)	12 AM		6.1 oz/mn (180 cc/mn)	7.5 in (19 cm)	12 AM	031-150-010	134-630-200	132-630-400	033-150-200
20-30 s	0.039 in (1.0 mm)	10 PGL	2.3 cfm (4 m³/h)	5 oz/mn (148 cc/mn)	5.1 in (13 cm)	10 PGL	031-150-007	134-640-100	132-640-100	033-150-300

LACQUERS, STAINS, VARNISHES

SPRAY GUNS S3 G HPA

Max fluid viscosity in CA 4	Projector type	Cup	Nozzle size	Fluid flow rate	Air consumption (m ³ /h)	Fan width at 8 inches (20 cm)	Part number
Very fluid / 14-20 s	08 AM	HDPE	0.031 in (0.8 mm)	2.9 oz/mn (86 cc/mn)	6.1 cfm (10.4 m ³ /h)	7 in (15 cm)	136-155-108
Fluid /20-30 s	10 AM	8.45 fl oz (0.25 L)	0.039 in (1.0 mm)	4.8 oz/mn (142 cc/mn)	6.1 cfm (10.4 m ³ /h)	8.6 in (22 cm)	136-155-109
Fluid /30-40 s	12 AM		0.047 in (1.2 mm)	6.1 oz/mn (180 cc/mn)	6.1 cfm (10.4 m ³ /h)	9.6 in (24.5 cm)	136-155-110
Fluid /20-30 s	10 PGL	(grey)	0.039 in (1.0 mm)	5 oz/mn(148 cc/mn)	2.4 cfm (4.1 m ³ /h)	5.1 in (13 cm)	136-155-107

MAINTENANCE

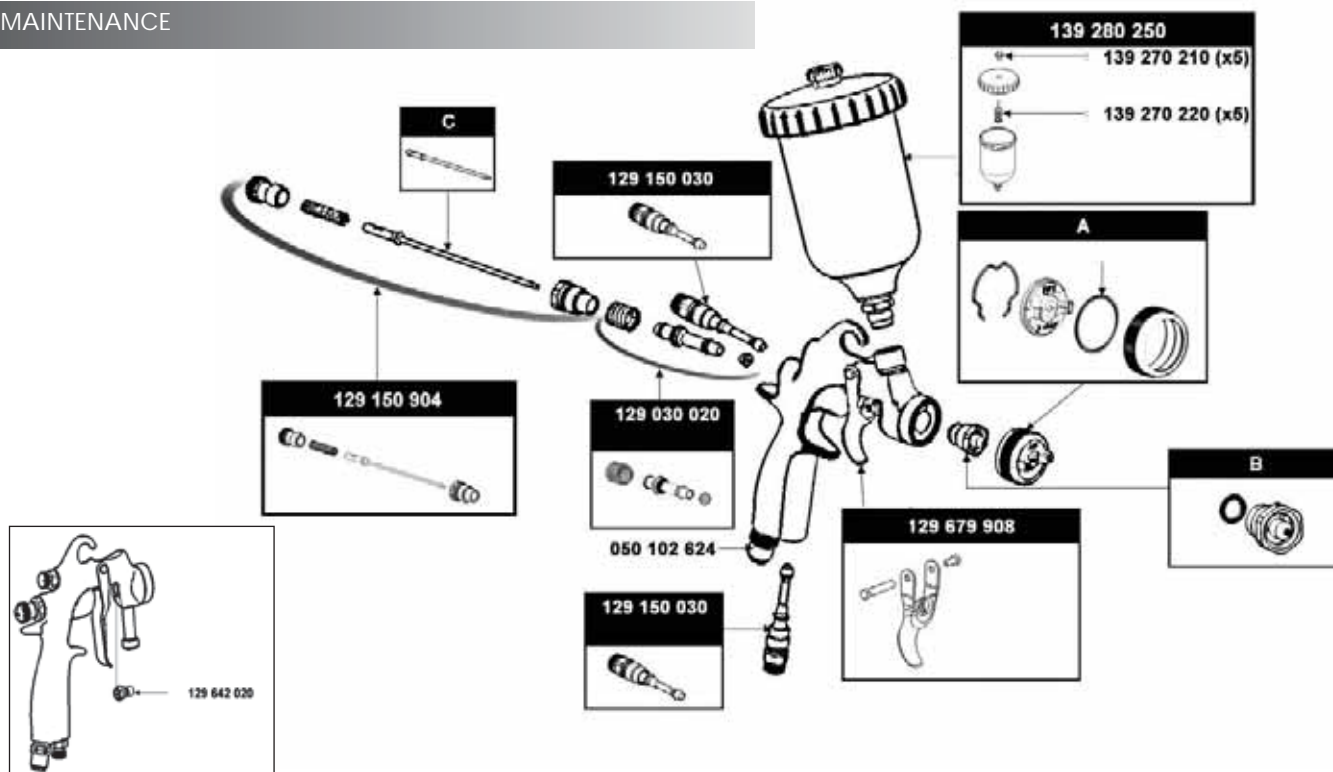

PROJECTORS

Projector type	Reference (A+B+C)	Size (mm)	Nozzle (B)		Aircap (A)		Needle (C)	
			Part number	Type	Part number	Type	Part number	Type
08 AM	031-150-008	0.8	134-630-400				08	033-150-100
10 AM	031-150-009	1.0	134-630-100	AM	132-630-400		10	033-150-500
12 AM	031-150-010	1.2	134-630-200				12	033-150-200
10 PGL	031-150-007	1.0	134-640-100	PGL	132-640-100		10 L	033-150-300

S3 A HPA



The S3 A HPA is our most compact suction fed gun with improved ergonomics for small hands and tight touch-up areas.

FEATURES	BENEFITS
New ergonomics and body design	The operator can focus on the spraying and applying the material, not the weight and stress of the gun and cup on their body
Reduced air consumption	Energy savings
In-line air valve assembly	Fine adjustment and long lasting components
2-finger trigger	Improved comfort for more productivity
E-Z adjust aircap	Allows adjustment without loosening the retaining ring
HDPE cup	Compatible with water-based materials, etc...

SPECIFICATIONS	
Sprayed materials	Shades, varnishes, lacquers, stains, Polyurethanes, 2 component
Body of the gun	Polished forged aluminum
Maximum air inlet pressure	87 psi (6 bar)
Recommended atomization air pressure	36 - 50 psi (2.5 - 3.5 bar)
Air consumption	4.7 - 6.5 cfm (8-11 m ³ /h)
Weight (with cup)	19.1 oz (595 g)
Maximum fluid pressure	87 psi (6 bar)
Maximum fluid temperature	122°F (50°C)
Nozzle	Stainless steel
Needle	Stainless steel
Wetted parts	Stainless steel

FITTINGS	
Air inlet	M 1/4" NPS
Fluid inlet (0.25L HDPE suction cup)	M 1/4" NPS



AIRCAP
AM
AY



CONFIGURATION OF THE S3 A HPA SPRAY GUN

Max fluid viscosity in CA 4	Projector type	Nozzle	Fluid flow rate	Air consumption	Fan width at 8 inches (20 cm)	Cup	Part number
		Size					
-	-	-	-	-	-	-	
14-20 s	08 AM	0.031 in (0.8 mm)	2.9 oz/mn (86 cc/mn)	7.6 cfm (12.9 m ³ /h)	5.9 in (15 cm)	HDPE 8.4 oz (0.25 L) (grey)	136-150-200
20-30 s	10 AM	0.039 in (1.0 mm)	4.5 oz/mn (133 cc/mn)		6.7 in (17 cm)		136-150-208
30-40 s	12 AM	0.047 in (1.2 mm)	5.4 oz/mn (159 cc/mn)		7.4 in (19 cm)		136-150-209
	15 AY	0.059 in (1.5 mm)	6.1 oz/mn (180 cc/mn)	7.8 in (20 cm)	136-150-211		

S3 A HPA



PROJECTORS FOR S3 A HPA AIRSPRAY GUNS

Max fluid viscosity in CA 4	Nozzle Size	Fluid flow rate	Fan width at 20 cm (cm)	Air consumption	Projector		Nozzle	Aircap	Needle
					Type	Part number			
< 20 s	0.031 in (0.8 mm)	2.9 oz/mn (86 cc/mn)	5.9 in (15 cm)	7.6 cfm (12.9 m ³ /h)	08 AM	031-150-008	134-630-400	132-630-400	033-150-100
	0.039 in (1.0 mm)	4.8 oz/mn (142 cc/mn)	6.7 in (17 cm)		10 AM	031-150-009	134-630-100	132-630-400	033-150-500
	0.047 in (1.2 mm)	6.1 oz/mn (180 cc/mn)	7.4 in (19 cm)		12 AM	031-150-010	134-630-200	132-630-400	033-150-200
20-40 s	0.059 in (1.5 mm)	6.1 oz/mn (180 cc/mn)	7.8 in (20 cm)	8.3 cfm (14.1 m ³ /h)	15 AY	031-150-011	134-630-300	132-630-200	033-150.400

PART NUMBER

Description	Part number
S3A, w/o cup, 08AM	668-150-208
S3A, w/o cup, 08AM, engraved (HVLP)	668-151-208
S3A, w/o cup, 08ESG KHVLP	668-150-108
S3A, w/o cup, 10AM	668-150-209
S3A, w/o cup, 10AM, engraved (HVLP)	668-151-209
S3A, w/o cup, 10ESG KHVLP	668-150-109
S3A, w/o cup, 12AM	668-150-210
S3A, w/o cup, 12AM, engraved (HVLP)	668-151-210
S3A, w/o cup, 12ESG KHVLP	668-150-110
S3A, w/o cup, 15AY	668-150-211
S3A, w/o cup, 15ESG KHVLP	668-150-111

SEAL KITS

Description	Part number
Seal kit	129-150-901
Repair kit (includes the seal kit)	129-150-902

S3 P HTi

S3 SPRAY GUNS



The S3 P HTi is our most compact pressure fed gun with outstanding ergonomics. Designed for small hands and tight areas where touch-up or shading is required.

FEATURES	BENEFITS
New ergonomics and body design	This small, lightweight HVLP gun allows the operator to focus on the application and the spraying movement for improved quality
Unique aircap design	Unsurpassed finish quality with perfectly balanced fan
E-Z adjust aircap	Allows adjustment without loosening the retaining ring
In-line air valve assembly	Fine adjustment and long lasting components
2-finger trigger	Improved comfort for more productivity

SPECIFICATIONS	
Sprayed materials	Shades, varnishes, lacquers, stains, Polyurethanes, 2 component
Body of the gun	Polished forged aluminum
Maximum air inlet pressure	87 psi (6 bar)
Recommended atomization air pressure	21 - 36 psi (1.5 - 2.5 bar)
Air consumption	7.1 cfm (12 m ³ /h)
Weight	12.4 oz (388 g)
Maximum fluid pressure	87 psi (6 bar)
Maximum fluid temperature	122°F (50°C)
Nozzle	Stainless steel
Needle	Stainless steel
Wetted parts	Stainless steel

FITTINGS	
Air inlet	M 1/4" NPS
Fluid inlet	M 1/4" NPS



NOTE: for HVLP compliance, the maximum inlet air pressure at the gun handle must not exceed 2 bar (29 psi) to maintain 10 psi or less at the air cap. Testing for HVLP compliance was performed using the specified HVLP test air cap, the fan control fully open and a pressure gauge on the Air inlet fitting at the gun base or handle. It may also be a requirement of some regulatory agencies that users have the appropriate test air cap available on site to verify that the gun is being operated within the regulatory limitations.

Description	Part number
Seal kit	129-150-901
Repair kit (includes the seal kit)	129-150-902

S3 P HTi







**AIRCAP
EPX KHVLP** 

CONFIGURATION OF THE S3 P HTI SPRAY GUN

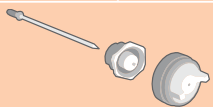
Max fluid viscosity in CA 4	Projector type	Nozzle	Fluid flow rate	Fan width at 20 cm (cm)	Part number
		Size			
-	-	-	-	-	 135-150-200
14-20 s	08 EPX KHVLP	0.031 in (0.8 cm)	10.1 oz/mn (300 cc/mn)	9.8 in (25 cm)	135-150-204
20-30 s	10 EPX KHVLP	0.039 in (1.0 cm)	15.6 oz/mn (461 cc/mn)	10.2 in (26 cm)	135-150-205
30-40 s	12 EPX KHVLP	0.047 in (1.2 cm)	25.2 oz/mn (745 cc/mn)	10.2 in (26 cm)	135-150-206

PROJECTORS FOR S3 P HTI SPRAY GUNS

Max fluid viscosity in CA 4	Nozzle Size	Air consumption	Fluid flow rate	Fan width at 8 inches (20 cm)	Projector		Nozzle	Aircap	Needle
					Type	Part number			
									
14-20 s	0.031 in (0.8 cm)	7.1 cfm (12 m³/h)	2.7 oz/mn (80 cc/mn)	9.8 in (25 cm)	08 EPX KHVLP	031-150-004	134-630-400	132-150-100	033-150-100
20-40 s	0.039 in (1.0 cm)		3.1 oz/mn (92 cc/mn)	10.2 in (26 cm)	10 EPX KHVLP	031-150-005	134-630-100	132-150-100	033-150-500
20-40 s	0.047 in (1.2 cm)		4.4 oz/mn (131 cc/mn)	10.2 in (26 cm)	12 EPX KHVLP	031-150-006	134-630-200	132-150-100	033-150-200

S3 P HPA



The S3 P HPA is our most compact pressure fed gun with outstanding ergonomics for small hands and tight touch-up areas.

FEATURES	BENEFITS
New ergonomics and body design	The operator can focus on the spraying and applying the material, not the weight and stress of the gun and cup on their body
Unique aircap design	Unsurpassed finish quality with perfectly balanced fan
E-Z adjust aircap	Allows adjustment without loosening the retaining ring
Reduced air consumption	Energy savings
In-line air valve assembly	Fine adjustment and long lasting components
2-finger trigger	Improved comfort for more productivity

SPECIFICATIONS	
Sprayed materials	Shades, varnishes, lacquers, stains, Polyurethanes, 2 component
Body of the gun	Polished forged aluminum
Maximum air inlet pressure	87 psi (6 bar)
Recommended atomization air pressure	43.5 psi (3 bar)
Air consumption	5.8 cfm (10 m ³ /h)
Weight	12.4 oz (387 g)
Maximum fluid pressure	87 psi (6 bar)
Maximum fluid temperature	122°F (50°C)
Nozzle	Stainless steel
Needle	Stainless steel
Wetted parts	Stainless steel



FITTINGS	
Air inlet	M 1/4" NPS
Fluid inlet	M 1/4" NPS



SEAL KITS	
Description	Part number
Seal kit	129-150-901
Repair kit (includes the seal kit)	129-150-902

**AIRCAP
PX
PGL**

CONFIGURATION OF THE S3 P HPA SPRAY GUN

Max fluid viscosity in CA 4	Projector type	Nozzle	Fluid flow rate	Fan width at 8 inches (20 cm)	Part number
		Size			
-	-	-	-	-	 135-150-200
14-20 s	08 PX	0.031 in (0.8 mm)	10.4 oz/mn (307 cc/mn)	9 in (23 cm)	135-150-201
20-30 s	10 PX	0.039 in (1.0 mm)	17.1 oz/mn (506 cc/mn)	9.2 in (23.5 cm)	135-150-202
30-40 s	12 PX	0.047 in (1.2 mm)	24.7 oz/mn (731 cc/mn)	9.8 in (25 cm)	135-150-203
20-30 s	10 PGL	0.039 in (1.0 mm)	5 oz/mn (148 cc/mn)	5.1 in (13 cm)	135-150-207

PROJECTORS FOR M22 P HPA SPRAY GUNS

Max fluid viscosity in CA 4	Nozzle	Air consumption	Fluid flow rate	Fan width at 8 inches (20 cm)	Projector		Aircap	Needle	Nozzle
	Size				Type	Part number			
									
14-20	0.031 in (0.8 mm)	5.8 cfm (10 m ³ /h)	10.4 oz/mn (307 cc/mn)	9 in (23 cm)	08 PX	031-150-001	132-631-100	033-150-100	134-630-400
20-30	0.039 in (1.0 mm)		17.1 oz/mn (506 cc/mn)	9.2 in (23.5 cm)	10 PX	031-150-002	132-631-100	033-150-500	134-630-100
30-40	0.047 in (1.2 mm)		24.7 oz/mn (731 cc/mn)	9.8 in (25 cm)	12 PX	031-150-003	132-631-100	033-150-200	134-630-200
20-30 s	0.039 in (1.0 mm)	2.3 cfm (4 m ³ /h)	5 oz/mn (148 cc/mn)	5.1 in (13 cm)	10 PGL	031-150-007	132-640-100	033-150-300	134-640-100

■ Aircaps for S3 airspray guns

AIRCAPS FOR HTI AIRSPRAY GUNS

	ESG K HVLP	EPX K HVLP
		
Guns	S3 G HTI	S3 P HTI
Fan shape	Flat	Flat
Atomization type	HTi	HTi
Atomization quality	Excellent	Excellent
Air consumption @ 29 psi (2 bar)	4.4 cfm (7.5 m ³ /h)	7.1 cfm (12 m ³ /h)
Nozzle size	08/12	08/12
Part number	132-150-200	132-150-100

AIRCAPS FOR HPA AIRSPRAY GUNS

	AM	AM	AY	PX
				
Guns	S3 G HPA	S3 A HPA	S3 A HPA	S3 P HPA
Fan shape	Flat	Flat	Flat	Flat
Atomization Type	HPA	HPA	HPA	HPA
Atomization quality	Very good	Very good	Very good	Very good
Transfer efficiency	72%	52%	54%	76%
Air consumption @ 29 psi (2 bar)	5.8 cfm (10 m ³ /h)	7.6 cfm (13 m ³ /h)	8.2 cfm (14 m ³ /h)	5.8 cfm (10 m ³ /h)
Nozzle size	08/12	08 /15	15	08/12
Part number	132-630-400	132-630-400	132-630-200	132-631-100

AIRCAPS FOR HPA AIRSPRAY GUNS - AIRCAPS FOR THE LINE

	PGL	PGL
		
Guns	S3 G HPA	S3 P HPA
Fan shape	Line	Line
Atomization type	HPA	HPA
Atomization quality	Very good	Very good
Nozzle size	10	10
Part number	132-640-100	132-640-100

PPS 650 S3 & M22 - GRAVITY AND SUCTION GUN LID, LINER CUP & COLLAR

Lid, Liner, Cup & Collar	Part number
Includes 50 lids/liners, 2 cups & collars & adaptor	
M22 Suction	668-000-300
S3 Suction	668-000-301
M22 / S3 Suction	668-000-302
Shop Package - PPS Starter Kit	
Includes 50 lids/liners	
Dispenser for liners	668-000-298
Dispenser for lids	
REFILLS	
PPS 650 ml lids and liners - Qty 50	668-000-241
ACCESSORIES	
Wash bottle	668-000-297
Film 650 - 10 pack	668-000-269



■ Extensions for M22 pressure fed guns

Designed for painting the inside of tubes (360° circular fan) or the inside of cavities (lateral fan)

EXTENSIONS FOR PRESSURE-FED M22 SPRAY GUNS				
Fan type	Internal diameter	Length	Nozzle type	Part number
Cone	0.31 in (8 mm)	5.9 in (150 mm)	12	075-900-213
Cone		5.9 in (150 mm)	18	075-900-224
Lateral		9.8 in (250 mm)	12	075-900-111
Lateral		9.8 in (250 mm)	18	075-900-122
Lateral		15.7 in (400 mm)	12	075-900-311
Lateral		15.7 in (400 mm)	18	075-900-322



■ M22 G & S3G adapter

PART NUMBER	
Description	Part number
PPS type 6 adapter, M22 G, S3G	668-000-246

■ Gravity cups

The grey cup is for Polyurethanes and pre-catalyzed paints.
The white cup is for water or solvent based paints.

PART NUMBERS GRAVITY CUPS FOR M22 G				
Description	Material	Capacity	Fitting	Part number
Grey cup (PU and pre-catalyzed paints)	HDPE	20.1 oz (0.6 L)	1/4" BSP	139-270-250
White cup (solvent and water-based paints)	Polyacetal	8.4 oz (0.25 L)	1/4" BSP	139-280-200
White cup (solvent or water-based paints)	Polyacetal	20.1 oz (0.6 L)	1/4" BSP	139-270-200

PART NUMBER GRAVITY CUP FOR S3 G				
Description	Material	Capacity	Fitting	Part number
Grey cup (PU and pre-catalysed paints)	HDPE	8.4 oz (0.25 L)	1/4" BSP	139-280-250
White cup (solvent and water-based paints)	Polyacetal	8.4 oz (0.25 L)	1/4" BSP	139-280-200



SEAL PACKS AND SCREENS		
Description	Quantity	Part number
Pack of non-drip plugs for 8.4 oz and 20.3 oz (0.25 liter and 0.6 liter) cups	5	139-270-210
Pack of screens for 8.4 oz and 20.3 oz (0.25 liter and 0.6 liter) cups (200 µm)	5	139-270-220

■ Suction cup - with non-drip system

1/4 turn quick opening SM6 aluminum twist cup (for M22 and M21)
1/4 turn quick opening HDPE cup (for S3A)

CUP PART NUMBERS FOR M22A				
Description	Material	Fitting	Capacity	Part number
Complete SM6 standard suction cup	Aluminum	F3/8" NPS	33.8 oz (1 L)	138-360-000
Fitted cover (with tube)	Aluminum	F 3/8" NPS	-	138-360-200
Cup only	Aluminum	-	33.8 oz (1 L)	138-350-100

CUP PART NUMBER FOR S3 A				
Description	Fitting	Material	Capacity	Part number
Suction cup (grey)	F 1/4" NPS	HDPE	8.4 oz (0.25 L)	138-390-000

SEAL PACKS FOR SM6		
Description	Quantity	Part number
Pack of cup seals	10	138-010-900
Pack of filters	4	138-310-300
Pack of non-drip plugs	5	138-350-901
Pack of filters for SM5 (old model)	4	138-010-800

SEAL PACKS FOR S3 A CUP		
Description	Quantity	Part number
Pack of 5 non-drip plugs for 8.4 oz and 20.3 oz (0.25 liter and 0.6 liter) cups	5	139-270-210
Pack of filters	4	138-310-300



■ Gravity pressure cup for M22 GSP

PART NUMBER

Description	Material	Capacity	Fitting	Part number
Pressure cup	HDPE (grey)	20.1 oz (0.6 L)	1/4" BSP	139-270-260

■ Hose sleeve

PART NUMBER

Description	Internal diameter	Length	Part number
Hose sleeve	1.6 in (40 mm)	32' 8" (10 m)	129-270-087

■ Test aircap - HVLP compliance

PART NUMBER

Fits gun series	Description	Part number
M22	E3 K HVLP aircap with test gauges	668-668-596
M22	E5 K HVLP aircap with test gauges	668-668-597



■ Accessories and filters for airspray guns

FLUID INLET FILTER

Description	Fittings on gun	Hoses thread	Part number
Fluid inlet filter with N°6 screen for M22 spray guns	F 3/8" NPS	M 3/8" NPS	129-140-030

SEAL PACKS FOR FLUID INLET FILTER

Description	Quantity	Part number
Pack of n°6 screens	10	151-399-902
Pack of seals	10	149-949-901





■ Gun cleaning kit

PART NUMBERS

Description	Part number
1/4 in (6.4 mm) nylon brush	668-000-395
Gun lubricant	
Tip cleaning needles	
Cleaning needle pin vise	
Contains all necessary items for spray gun maintenance	



VARIOUS ACCESSORIES

Image	Description	Fittings on gun	Hoses thread	Part number
	Air inlet swivel fitting	M1/4" G - F 1/4" G		129-020-070
	Air inlet quick-disconnect fitting	F 1/4" NPS / M 1/4" NPS		905-030-105
	Gun inlet pressure gauge for HVLP compliance testing	MF 1/4" NPS		150-070-560
	Table stand for gravity-fed spray gun (gun not included)	-		049-221-800
	Wall support for gravity-fed spray gun	-		049-221-900

A35 HTi

MODULAR AUTOMATIC GUNS



Modular design for high volume production with an outstanding finish quality - HTi technology.

FEATURES	BENEFITS
Excellent atomization quality with outstanding transfer efficiency	Excellent finish quality, reduced paint costs, cleaner working environment, lower booth maintenance
Modular design	Quick service: only 4 bolts to unscrew, no need to remove hoses
Built-in valve	Non air-bleeding gun
Indexed aircap 0 - 90°	Perfect readjustment of fan pattern
Fluid output adjustment by indexed button	High precision fluid regulation
Stainless steel construction	Compatible with water-based materials

SPECIFICATIONS	
Maximum air inlet pressure	87 psi (6 bar)
Maximum fluid pressure	87 psi (6 bar)
Trigger air pressure	43 psi (3 bar - mini)
Recommended atomization air pressure	29 - 36 psi (2 - 2.5 bar)
Fluid output	Upon nozzle (see table)
Weight (gun only)	15.9 oz (497 g)
Maximum fluid temperature	122°F (50°C)
Transfer efficiency in % (EN 13966-1)	74 (E3 KHVLP) - 72 (EP3)
Air consumption	11.7 - 17.6 cfm (20 - 30 m³/h)
Wetted parts	Stainless steel - treated stainless steel

BASE FOR A35 HTI GUNS		
Type	Side outputs	Rear outputs
Fluid circulation	Circulation in the base	Circulation in the base ()
Material (base plate)	Aluminum with stainless steel insert	Aluminum with stainless steel insert
Weight	7.7 oz (240 g)	15.4 oz (480 g)

FITTINGS		
Power supply	Gun base	Fittings supplied, non fitted
Fluid	F 1/4" NPS	Quick fittings - Ø 6 x 8 hose
Atomization air	F 1/4" NPS	M 1/4 NPS - air hose int Ø 8 mini
Pilot air	F 1/8" NPS	Quick fittings -air hose Ø 4x6



SUPPORTS	
Description	Part number
Mounting support 5/8" Ø16	049-351-000
Mounting support 1/2" Ø12	049-351-700
Adjustable mounting support for 1/2" Ø12 support	049-351-705
Protective cap (x10)	106-380-818

KIT	
Description	Part number
Remote adjusting fan width kit	029-253-002

CONFIGURATION OF THE A35 HTI GUN FITTED WITH BASE - E3 KHVLP AIRCAP

Description	Projector	Base type	Nozzle Size	Fluid output	Fan width at 8 inches (20 cm)		Part number
					Minimum	Maximum	
							
A35 HTi	06 E3 KHVLP	Side outputs	0.023 in (0.6 mm)	5.1 oz/mn (150 cc/mn)	3.9 in (10 cm)	9.8 in (25 cm)	135-300-112
A35 HTi		Rear outputs					135-300-212
A35 HTi	07 E3 KHVLP	Side outputs	0.027 in (0.7 mm)	6.7 oz/mn (200 cc/mn)		11.4 in (29 cm)	135-300-101
A35 HTi		Rear outputs					135-300-201
A35 HTi	09 E3 KHVLP	Side outputs	0.035 in (0.9 mm)	8.5 oz/mn (250 cc/mn)		13.8 in (35 cm)	135-300-102
A35 HTi		Rear outputs					135-300-202
A35 HTi	12 E3 KHVLP	Side outputs	0.047 in (1.2 mm)	10.1 oz/mn (300 cc/mn)		13.8 in (35 cm)	135-300-103
A35 HTi		Rear outputs					135-300-203
A35 HTi	15 E3 KHVLP	Side outputs	0.059 in (1.5 mm)	11.8 oz/mn (350 cc/mn)		16.1 in (41 cm)	135-300-104
A35 HTi		Rear outputs					135-300-204
A35 HTi	18 E3 KHVLP	Side outputs	0.071 in (1.8 mm)	13.5 oz/mn (400 cc/mn)	16.9 in (43 cm)	135-300-105	
A35 HTi		Rear outputs				135-300-205	

A35 HTi

MODULAR AUTOMATIC GUNS



PROJECTORS E3 K HVLP FOR A35 HTI GUNS

Product viscosity in CA4 (s) or centipoises (cps)	Nozzle Size	Air consumption	Fluid flow rate oz/mn	Fan width at 8 inches (20 cm)		Projector		Nozzle Part number	Aircap Part number	Needle Part number
				Maximum	Minimum	Type	Part number			
< 20 s	0.023 in (0.6 mm)	11.7 - 17.6 cfm (20 - 30 m³/h)	5.1 (150)	9.8 in (25cm)	3.9 in (10 cm)	06 E3 K HVLP	031-300-012	134-130-050	132-300-100	033-300-100
	0.027 in (0.7 mm)		6.7 (200)	11.4 in (29 cm)		07 E3 K HVLP	031-300-001	134-130-100	132-300-100	033-300-100
	0.035 in (0.9 mm)		8.5 (250)	13.8 in (35 cm)		09 E3 K HVLP	031-300-002	134-130-200	132-300-100	033-300-100
	0.047 in (1.2 mm)		10.1 (300)	14.9 in (38 cm)		12 E3 K HVLP	031-300-003	134-130-300	132-300-100	033-300-100
20 - 40 s	0.059 in (1.5 mm)		11.8 (350)	16.1 in (41cm)		15 E3 K HVLP	031-300-004	134-130-600	132-300-100	033-300-200
	0.071 in (1.8 mm)		13.5 (400)	16.9 in (43 cm)		18 E3 K HVLP	031-300-005	134-130-700	132-300-100	033-300-200

AIRCAP EP3



CONFIGURATION OF THE A35 HTI GUN FITTED WITH BASE - EP3 AIRCAP

Description	Projector type	Base type	Nozzle size	Fluid output	Fan width at 8 inches (20 cm)		Part number
					Minimum	Maximum	
A35 HTi	06 EP3	Side outputs	0.023 in (0.6 mm)	5.1 oz/mn (150 cc/mn)	3.9 in (10 cm)	9.4 in (24 cm)	135-300-111
A35 HTi		Rear outputs					135-300-211
A35 HTi	07 EP3	Side outputs	0.027 in (0.7 mm)	6.7 oz/mn (200 cc/mn)		9.8 in (25 cm)	135-300-106
A35 HTi		Rear outputs					135-300-206
A35 HTi	09 EP3	Side outputs	0.035 in (0.9 mm)	8.5 oz/mn (250 cc/mn)		12.2 in (31 cm)	135-300-107
A35 HTi		Rear outputs					135-300-207
A35 HTi	12 EP3	Side outputs	0.047 in (1.2 mm)	10.1 oz/mn (300 cc/mn)		12.6 in (32 cm)	135-300-108
A35 HTi		Rear outputs					135-300-208
A35 HTi	15 EP3	Side outputs	0.059 in (1.5 mm)	11.8 oz/mn (350 cc/mn)		13.4 in (34 cm)	135-300-109
A35 HTi		Rear outputs					135-300-209
A35 HTi	18 EP3	Side outputs	0.071 in (1.8 mm)	13.5 oz/mn (400 cc/mn)	14.9 in (38 cm)	135-300-110	
A35 HTi		Rear outputs				135-300-210	

PROJECTORS EP3 FOR A35 HTI GUNS

Product viscosity in CA4 (s) or centipoises (cps)	Nozzle Size	Air consumption	Fluid flow rate	Fan width at 8 inches (20 cm)		Projector		Nozzle part number	Aircap Part number	Needle part number
				Maximum	Minimum	Type	Part number			
< 20 s	0.023 in (0.6 mm)	12.3 - 17.1 cfm (21 - 29 m³/h)	5.1 oz/mn (150 cc/mn)	9.4 in (24 mm)	3.9 in (10 cm) (100 mm)	06 EP3	031-300-011	134-130-050	132-300-300	033-300-100
	0.027 in (0.7 mm)		6.7 oz/mn (200 cc/mn)	9.8 in (25 mm)		07 EP3	031-300-006	134-130-100	132-300-300	033-300-100
	0.035 in (0.9 mm)		8.5 oz/mn (250 cc/mn)	12.2 in (31 mm)		09 EP3	031-300-007	134-130-200	132-300-300	033-300-100
	0.047 in (1.2 mm)		10.1 oz/mn (300 cc/mn)	12.6 in (32 mm)		12 EP3	031-300-008	134-130-300	132-300-300	033-300-100
20 - 40 s	0.059 in (1.5 mm)		11.8 oz/mn (350 cc/mn)	13.4 in (34 mm)		15 EP3	031-300-009	134-130-600	132-300-300	033-300-200
	0.071 in (1.8 mm)		13.5 oz/mn (400 cc/mn)	14.9 in (38 mm)		18 EP3	031-300-010	134-130-700	132-300-300	033-300-200

Description	Part number
A35 HTi, 06 E3 KHVLP, c/w Cefla base fitting kit	668-300-112
A35 HTi, 06 E5 KHVLP, w/o base, indexing aircap	668-300-012
A35 HTi, 06 E5 KHVLP, c/w Cefla base fitting kit	668-300-124
A35 HTi, 06 EP3 KHVLP, c/w Cefla base fitting kit	668-300-111
A35 HTi, 06 EP5 KHVLP, c/w Cefla base fitting kit	668-300-123
A35 HTi, 06 EP5, w/o base	668-300-011
A35 HTi, 07 E3 KHVLP, c/w Cefla base fitting kit	668-300-101
A35 HTi, 07 E5, w/o base, c/w delrin needle	668-300-302
A35 HTi, 07 EN3L, c/w base side inlet, s/s bsp elbows	668-300-301

Description	Part number
A35 HTi, 07 EP3 KHVLP, c/w Cefla base fitting kit	668-300-106
A35 HTi, 09 E3 KHVLP, c/w Cefla base fitting kit	668-300-102
A35 HTi, 09 EP3 KHVLP, c/w Cefla base fitting kit	668-300-107
A35 HTi, 12 E3 KHVLP, c/w Cefla base fitting kit	668-300-103
A35 HTi, 12 EP3 KHVLP, c/w Cefla base fitting kit	668-300-108
A35 HTi, 15 E3 KHVLP, c/w Cefla base fitting kit	668-300-104
A35 HTi, 15 EP3 KHVLP, c/w Cefla base fitting kit	668-300-109
A35 HTi, 18 E3 KHVLP, c/w Cefla base fitting kit	668-300-105
A35 HTi, 18 EP3 KHVLP, c/w Cefla base fitting kit	668-300-110

A35 HPA

MODULAR AUTOMATIC GUNS



Modular design for High Volume Production with an excellent finish quality - HPA technology. Wide fan pattern available.

FEATURES	BENEFITS
Excellent atomization quality with outstanding transfer efficiency	Excellent finish quality, reduced paint costs, cleaner working environment, lower booth maintenance
New EN3L aircap	Unsurpassed wide fan pattern
Modular design	Quick service: only 4 bolts to unscrew, no need to remove hoses
Built-in valve	Non air-bleeding gun
Indexed aircap 0 - 90°	Perfect readjustment of fan pattern
Fluid output adjustment by indexed button	High precision fluid regulation
Stainless steel construction	Compatible with water-based materials



SPECIFICATIONS	
Maximum air inlet pressure	87 psi (6 bar)
Maximum fluid pressure	87 psi (6 bar)
Trigger air pressure	43 psi (3 bar) mini
Recommended atomization air pressure	43 - 72 psi (3 - 5 bar)
Fluid output	Upon nozzle (see table)
Weight (gun only)	15.9 oz (497 g)
Maximum fluid temperature	122°F (50°C)
Air consumption	19.4 cfm (33 m³/h)
Wetted parts	Stainless steel - treated stainless steel

FITTINGS		
Supply	Gun base	Fittings supplied, non fitted
Fluid	F 1/4" NPS	Quick fitting - Ø 6 x 8 hose
Atomization air	F 1/4" NPS	M 1/4" NPS - air hose Ø 7mm int
Pilot air	F 1/8" NPS	Quick fittings - air hose Ø 4x6

CONFIGURATION OF THE A35 HPA GUN WITHOUT BASE			
Description	Aircap	Nozzle	Part number
A35 HPA without projector, w/o base	-	-	129-305-000



CONFIGURATION OF THE A35 HPA GUN FITTED WITH BASE							
Description	Projector type	Base type	Nozzle Size	Fluid flow rate	Fan width at 8 inches (20 cm)		Part number
					Minimum	Maximum	
A35 HPA	06 EN3L	Side outputs	0.023 in (0.6 mm)	5.1 oz/mn (150 cc/mn)	3.9 in (10 cm)	11.8 in (30 cm)	135-305-106
A35 HPA		Rear outputs					135-305-206
A35 HPA	07 EN3L	Side outputs	0.027 in (0.7 mm)	6.7 oz/mn (200 cc/mn)		12.2 in (31 cm)	135-305-101
A35 HPA		Rear outputs					135-305-201
A35 HPA	09 EN3L	Side outputs	0.035 in (0.9 mm)	8.5 oz/mn (250 cc/mn)		13.4 in (34 cm)	135-305-102
A35 HPA		Rear outputs					135-305-202
A35 HPA	12 EN3L	Side outputs	0.047 in (1.2 mm)	10.1 oz/mn (300 cc/mn)		14.9 in (38 cm)	135-305-103
A35 HPA		Rear outputs					135-305-203
A35 HPA	15 EN3L	Side outputs	0.059 in (1.5 mm)	11.8 oz/mn (350 cc/mn)		15.4 in (39 cm)	135-305-104
A35 HPA		Rear outputs					135-305-204
A35 HPA	18 EN3L	Side outputs	0.071 in (1.8 mm)	13.5 oz/mn (400 cc/mn)	16.1 in (41 cm)	135-305-105	
A35 HPA		Rear outputs				135-305-205	

A35 HPA

MODULAR AUTOMATIC GUNS



PROJECTORS EN3L FOR A35 HPA GUNS

Product viscosity in CA4 (s) or centipoises (cps)	Nozzle Size	Fan width at 8 inches (20 cm)		Air consumption	Fluid flow rate	Projector		Nozzle	Aircap	Needle
		Minimum	Maximum			Type	Part number			
< 20 s	0.023 in (0.6 mm)	3.9 in (10 mm) (100 mm)	11.8 in (30 cm)	14.1 - 25.9 cfm (24 - 44 m³/h)	5.1 oz/mn (150 cc/mn)	06 EN3L	031-305-006	134-130-050	132-305-200	033-300-100
	0.027 in (0.7 mm)		12.2 in (31 cm)		6.7 oz/mn (200 cc/mn)	07 EN3L	031-305-001	134-130-100	132-305-200	033-300-100
	0.035 in (0.9 mm)		13.4 in (34 cm)		8.5 oz/mn (250 cc/mn)	09 EN3L	031-305-002	134-130-200	132-305-200	033-300-100
	0.047 in (1.2 mm)		14.9 in (38 cm)		10.1 oz/mn (300 cc/mn)	12 EN3L	031-305-003	134-130-300	132-305-200	033-300-100
20 - 40 s	0.059 in (1.5 mm)		15.4 in (39 cm)		11.8 oz/mn (350 cc/mn)	15 EN3L	031-305-004	134-130-600	132-305-200	033-300-200
	0.071 in (1.8 mm)	16.1 in (41 cm)	13.5 oz/mn (400 cc/mn)	18 EN3L	031-305-005	134-130-700	132-305-200	033-300-200		

PART NUMBER FOR A35 HPA GUNS

Description	Part number
A35 HPA, 06 EN3L, c/w Cefla base fitting kit	668-305-106
A35 HPA, 07 EN3L, c/w Cefla base fitting kit	668-305-101
A35 HPA, 09 EN3L, c/w Cefla base fitting kit	668-305-102
A35 HPA, 12 EN3L, c/w Cefla base fitting kit	668-305-103
A35 HPA, 15 EN3L, c/w Cefla base fitting kit	668-305-104
A35 HPA, 18 EN3L, c/w Cefla base fitting kit	668-305-105

SUPPORTS

Description	Part number
Mounting support 5/8" Ø16	049-351-000
Mounting support 1/2" Ø12	049-351-700
Adjustable mounting support for 1/2" Ø12 support	049-351-705
Protective cap (x10)	106-380-818

KITS

Description	Part number
Remote adjusting fan width kit	029-253-002

A25F FLOWMAX[®]

MODULAR AUTOMATIC GUNS



Flowmax[®] technology: unsurpassed reliability and multi-products use. The A25F Flowmax[®] gun is designed for intensive use. The sealing of the gun is made with a Bellows guaranteeing a high level of reliability. It is recommended for spraying paints, glues, water-based materials and UV products.

FEATURES	BENEFITS
Excellent atomization quality with outstanding transfer efficiency	Excellent finish quality, reduced paint costs, cleaner working environment, lower booth maintenance
Unique custom-made design of fluid passages at the Bellows level	Optimized flushing and fluid circulation
Adoption of a Bellows seal	Increased reliability
Stainless steel construction	Compatible with solvent or water-based materials
Flushing volume optimized by the Bellows technology	Easy flushing and product savings
Modular design	The body of the gun can be easily removed from the base: only 4 bolts needed to release, no need to remove hoses and it maintains optimal position even after servicing Dismounting and set-up without hose removal



Gun shown fitted on base

SPECIFICATIONS	
Maximum air inlet pressure	87 psi (6 bar)
Maximum fluid pressure	87 psi (6 bar)
Trigger air pressure	58 psi (4 bar) mini
Fluid output	upon nozzle
Weight (gun only)	34.7 (985 g)
Weight (gun with base plate)	41.1 oz (1280 g)
Maximum fluid temperature	122°F (50°C)
Air consumption @ 36 psi (2.5 bar)	14.1 cfm (24 m ³ /h)
Body of the gun	Stainless steel
Wetted parts	Stainless steel - PTFE

FITTINGS		
Supply	Gun base	Non fitted supplied fitting
Fluid	F 1/4" NPS	Elbow M 1/4" BSP - Ø 6x8 hose
Control Air	F 1/8" NPS	M 1/8" BSP - Ø 4x6 hose
Spraying air	F 1/4" NPS	Straight M 1/4" BSP - M 1/4" NPS for conductive hose Ø8 int min

SUPPORTS	
Description	Part number
Mounting support 5/8" Ø16	049-351-000
Mounting support 1/2" Ø12	049-351-700
Adjustable mounting support for 1/2" Ø12 support	049-351-705
Protective cap (x10)	106-380-818

Description	Part number
Remote adjusting fan width kit	029-253-002

A25F FLOWMAX®

MODULAR AUTOMATIC GUNS



AIRCAP
N3C



A25F FLOWMAX® GUN KIT WITH BASE

Description	Projector	Max fluid viscosity in CA 4	Nozzle Size	Fluid output	Fan width at 8 inches (20 cm)		Part number with base
					Minimum	Maximum	
A25F Flowmax®	07 N3C	20 - 30s	0.027 in (0.7 mm)	6.7 oz/mn (200 cc/mn)	3.9 in (10 mm) (100 mm)	9.4 in (24 cm)	151-260-809
A25F Flowmax®	09 N3C	20 - 30s	0.035 in (0.9 mm)	8.4 oz/mn (250 cc/mn)		10.2 in (26 cm)	151-260-810
A25F Flowmax®	12 N3C	20 - 30s	0.047 in (1.2 mm)	10.1 oz/mn (300 cc/mn)		13.4 in (34 cm)	151-260-811

PART NUMBERS

Product viscosity in CA4 (s) or centipoises (cps)	Description	Nozzle Size	Air consumption	Fluid flow rate	Fan width at 8 inches (20 cm)		Nozzle part number	Aircap part number	Needle part number
					Minimum	Maximum			
< 20 s	07 N3C	0.027 in (0.7 mm)	12.9 cfm (22 m³/h)	6.1 oz/mn (180 cc/mn)	2.3 in (6 cm)	13.8 in (35 cm)	134-021-100	132-021-750	033-420-100
	09 N3C	0.035 in (0.9 mm)	12.9 cfm (22 m³/h)	8.5 oz/mn (250 cc/mn)	2.3 in (6 cm)	13.8 in (35 cm)	134-020-100	132-021-750	033-420-100
	12 N3C	0.047 in (1.2 mm)	12.9 cfm (22 m³/h)	11.8 oz/mn (350 cc/mn)	2.3 in (6 cm)	13.8 in (35 cm)	134-020-200	132-021-750	033-420-100



A29 HTi

Universal gun suitable for a wide range of applications - Recommended for filled materials and small output applications requiring high precision. High finish quality due to HTi technology.

FEATURES	BENEFITS
High opening/closing frequency	High production
Needle sealing done by a self-adjusting cartridge	Outstanding reliability
Independent fan and atomization control	Optimized finish quality and pattern size
Indexed aircap 0 - 90°	Perfect readjustment of fan pattern
Fluid output adjustment by indexing knob	High precision fluid regulation
Optimized inlet and outlet fluid ports	Optimum spraying of high viscosity materials (circulation recommended to keep product homogeneity)



SPECIFICATIONS	
Maximum air inlet pressure	87 psi (6 bar)
Maximum fluid pressure	87 psi (6 bar)
Trigger air pressure	45 psi (3 bar) mini
Fluid output	Upon nozzle (see table)
Weight (gun only)	19.8 oz (585 g)
Maximum fluid temperature	122°F (50°C)
Air consumption	11.7 - 17.6 cfm (20 - 30 m³/h)
Fluid circulation	yes
Wetted parts	Stainless steel - Treated stainless steel

FITTINGS		
Fluid	M 3/8 NPS	Ø 7 mn Int hose
Atomization air	Push lock	Ø 8 x 10 polyamide hose
Pilot air	Push lock	Ø 4 x 6 polyamide hose



CONFIGURATION OF THE A29 HTI SPRAY GUN FITTED WITH KHVLP AIRCAP

Description	Projector	Nozzle Size	Fluid flow rate	Fan width at 8 inches (20 cm)		Part number
				Minimum	Maximum	
A29 HTi	06 E3 KHVLP	0.023 in (0.6 mm)	5.1 oz/mn (150 cc/mn)	3.9 in (10 cm)	9.8 in (25 cm)	135-310-012
A29 HTi	07 E3 KHVLP	0.027 in (0.7 mm)	6.7 oz/mn (200 cc/mn)	3.9 in (10 cm)	11.4 in (29 cm)	135-310-001
A29 HTi	09 E3 KHVLP	0.035 in (0.9 mm)	8.4 oz/mn (250 cc/mn)	3.9 in (10 cm)	13.8 in (35 cm)	135-310-002
A29 HTi	12 E3 KHVLP	0.047 in (1.2 mm)	10.1 oz/mn (300 cc/mn)	3.9 in (10 cm)	14.9 in (38 cm)	135-310-003
A29 HTi	15 E3 KHVLP	0.059 in (1.5 mm)	11.8 oz/mn (350 cc/mn)	3.9 in (10 cm)	16.1 in (41 cm)	135-310-004
A29 HTi	18 E3 KHVLP	0.0708 in (1.8 mm)	13.5 oz/mn (400 cc/mn)	3.9 in (10 cm)	16.9 in (43 cm)	135-310-005

PROJECTORS EP3 K HVLP FOR A29 HTI GUNS

Product viscosity in CA4 (s) or centipoises (cps)	Nozzle Size	Air consumption	Fluid flow rate	Fan width at 8 inches (20 cm)		Projector		Nozzle Part number	Aircap Part number	Needle Part number				
				Maximum	Minimum	Type	Part number							
< 20 s	0.023 in (0.6 mm)	11.7 - 17.6 cfm (20 - 30 m³/h)	5.1 (150)	9.8 in (25 cm)	3.9 in (10 cm)					06 E3 K HVLP	031-300-012	134-130-050	132-300-100	033-300-100
	0.027 in (0.7 mm)		6.7 (200)	11.4 in (29 cm)						07 E3 K HVLP	031-300-001	134-130-100	132-300-100	033-300-100
	0.035 in (0.9 mm)		8.4 (250)	13.8 in (35 cm)						09 E3 K HVLP	031-300-002	134-130-200	132-300-100	033-300-100
	0.047 in (1.2 mm)		10.1 (300)	14.9 in (38 cm)						12 E3 K HVLP	031-300-003	134-130-300	132-300-100	033-300-100
20 - 40 s	0.059 in (1.5 mm)		11.8 (350)	16.1 in (41 cm)						15 E3 K HVLP	031-300-004	134-130-600	132-300-100	033-300-200
	0.0708 in (1.8 mm)		13.5 (400)	16.9 in (43 cm)						18 E3 K HVLP	031-300-005	134-130-700	132-300-100	033-300-200

A29 HTi

NON-MODULAR AUTOMATIC GUNS





AIRCAP
EP3



CONFIGURATION OF THE A29 HTI SPRAY GUN FITTED WITH EP3 AIRCAP

Description	Projector	Nozzle Size	Fluid flow rate	Fan width at 8 inches (20 cm)		Part number
				Minimum	Maximum	
						
A29 HTI	06 EP3	0.023 in (0.6 mm)	5.1 oz/mn (150 cc/mn)	3.9 in (10 cm)	9.4 in (24 cm)	135-310-011
A29 HTI	07 EP3	0.027 in (0.7 mm)	6.7 oz/mn (200 cc/mn)	3.9 in (10 cm)	9.8 in (25 cm)	135-310-006
A29 HTI	09 EP3	0.035 in (0.9 mm)	8.4 oz/mn (250 cc/mn)	3.9 in (10 cm)	12.2 in (31 cm)	135-310-007
A29 HTI	12 EP3	0.047 in (1.2 mm)	10.1 oz/mn (300 cc/mn)	3.9 in (10 cm)	12.6 in (32 cm)	135-310-008
A29 HTI	15 EP3	0.059 in (1.5 mm)	11.8 oz/mn (350 cc/mn)	3.9 in (10 cm)	13.4 in (34 cm)	135-310-009
A29 HTI	18 EP3	0.0708 in (1.8 mm)	13.5 oz/mn (400 cc/mn)	3.9 in (10 cm)	14.9 in (38 cm)	135-310-010

PROJECTORS EP3 FOR A29 HTI GUNS

Product viscosity in CA4 (s) or centipoises (cps)	Nozzle Size	Air consumption	Fluid flow rate	Fan width at 8 inches (20 cm)		Projector		Nozzle Part number	Aircap Part number	Needle Part number
				Maximum	Minimum	Type	Part number			
										
< 20 s	0.023 in (0.6 mm)	12.3 - 17.1 cfm (21 - 29 m³/h)	5.1 oz/mn (150 cc/mn)	9.4 in (24 cm)	3.9 in (10 cm)	06 EP3	031-300-011	134-130-050	132-300-300	033-300-100
	0.027 in (0.7 mm)	12.3 - 17.1 cfm (21 - 29 m³/h)	6.7 oz/mn (200 cc/mn)	11.4 in (29 cm)	3.9 in (10 cm)	07 EP3	031-300-006	134-130-100	132-300-300	033-300-100
	0.035 in (0.9 mm)	12.3 - 17.1 cfm (21 - 29 m³/h)	8.4 oz/mn (250 cc/mn)	12.2 in (31 cm)	3.9 in (10 cm)	09 EP3	031-300-007	134-130-200	132-300-300	033-300-100
	0.047 in (1.2 mm)	12.3 - 17.1 cfm (21 - 29 m³/h)	10.1 oz/mn (300 cc/mn)	12.6 in (32 cm)	3.9 in (10 cm)	12 EP3	031-300-008	134-130-300	132-300-300	033-300-100
20 - 40 s	0.059 in (1.5 mm)	12.3 - 17.1 cfm (21 - 29 m³/h)	11.8 oz/mn (350 cc/mn)	13.4 in (34 cm)	3.9 in (10 cm)	15 EP3	031-300-009	134-130-600	132-300-300	033-300-200
	0.0708 in (1.8 mm)	12.3 - 17.1 cfm (21 - 29 m³/h)	13.5 oz/mn (400 cc/mn)	14.9 in (38 cm)	3.9 in (10 cm)	18 EP3	031-300-010	134-130-700	132-300-300	033-300-200

SUPPORTS AND ACCESSORIES

Description	Part number
Mounting support 5/8" Ø16	049-351-000
Adjustable mounting support for 1/2" Ø12 support	049-351-705
Protective cap (x10)	106-380-818



A29 HPA

Universal gun suitable for a wide range of applications - Recommended for filled materials and small output applications requiring high precision. High finish quality due to HPA technology.



FEATURES	BENEFITS
High opening/closing frequency	Intensive production
Needle sealing done by a self-adjusting cartridge	Outstanding reliability
New EN 3L aircap	Unsurpassed wide fan pattern
Independent fan and atomization control	Optimized finish quality and pattern size
Indexed aircap 0 - 90°	Perfect readjustment of fan pattern
Fluid output adjustment by indexed button	High precision fluid regulation
Optimized inlet and outlet fluid ports	Optimum spraying of high viscosity materials (circulation recommended to keep product homogeneity)

SPECIFICATIONS	
Maximum air inlet pressure	87 psi (6 bar)
Maximum fluid pressure	87 psi (6 bar)
Trigger air pressure	45 psi (3 bar) mini
Fluid output	Upon nozzle (see table)
Weight (gun only)	18.6 oz (585 g)
Maximum fluid temperature	122°F (50°C)
Air consumption	14.1 - 25.9 cfm (24 - 44 m³/h)
Wetted parts	Aluminum - Stainless steel

FITTINGS		
Fluid	M 3/8" NPS	Ø 7 mm int hose
Atomization air	Push lock	Ø 8 x 10 polyamide hose
Pilot air	Push lock	Ø 4 x 6 polyamide hose

SUPPORTS AND ACCESSORIES	
Description	Part number
Mounting support 5/8" Ø16	049-351-000
Adjustable mounting support for 1/2" Ø12 support	049-351-705
Protective cap for automatic guns (6)	106-380-856

AIRCAP EN3L



CONFIGURATION OF THE A29 HPA SPRAY GUN

Description	Projector	Nozzle Size	Fluid flow rate	Fan width at 8 inches (20 cm)		Part number
				Minimum	Maximum	
A29 HPA	06 EN 3L	0.023 in (0.6 mm)	5.1 oz/mn (150 cc/mn)	3.9 in (10 cm)	11.8 in (30 cm)	135-315-006
A29 HPA	07 EN 3L	0.027 in (0.7 mm)	6.7 oz/mn (200 cc/mn)	3.9 in (10 cm)	12.2 in (31 cm)	135-315-001
A29 HPA	09 EN 3L	0.035 in (0.9 mm)	8.4 oz/mn (250 cc/mn)	3.9 in (10 cm)	13.4 in (34 cm)	135-315-002
A29 HPA	12 EN 3L	0.047 in (1.2 mm)	10.1 oz/mn (300 cc/mn)	3.9 in (10 cm)	14.9 in (38 cm)	135-315-003
A29 HPA	15 EN 3L	0.059 in (1.5 mm)	11.8 oz/mn (350 cc/mn)	3.9 in (10 cm)	15.3 in (39 cm)	135-315-004
A29 HPA	18 EN 3L	0.0708 in (1.8 mm)	13.5 oz/mn (400 cc/mn)	3.9 in (10 cm)	16.1 in (41 cm)	135-315-005

PROJECTORS EN3L K FOR A29 HPA GUNS

Product viscosity in CA4 (s) or centipoises (cps)	Nozzle Size	Fluid flow rate	Air consumption	Fan width at 8 inches (20 cm)		Projector		Nozzle Part number	Aircap Part number	Needle Part number
				Minimum	Maximum	Type	Part number			
< 20 s	0.023 in (0.6 mm)	5.1 oz/mn (150 cc/mn)	14.1 - 25.9 cfm (24 - 44 m³/h)	3.9 in (10 cm)	11.8 in (30 cm)	06 EN 3L	031-305-006	134-130-050	132-305-200	033-300-100
	0.027 in (0.7 mm)	6.7 oz/mn (200 cc/mn)		3.9 in (10 cm)	12.2 in (31 cm)	07 EN 3L	031-305-001	134-130-100	132-305-200	033-300-100
	0.035 in (0.9 mm)	8.4 oz/mn (250 cc/mn)		3.9 in (10 cm)	13.4 in (34 cm)	09 EN 3L	031-305-002	134-130-200	132-305-200	033-300-100
	0.047 in (1.2 mm)	10.1 oz/mn (300 cc/mn)		3.9 in (10 cm)	14.9 in (38 cm)	12 EN 3L	031-305-003	134-130-300	132-305-200	033-300-100
20 - 40 s	0.059 in (1.5 mm)	11.8 oz/mn (350 cc/mn)		3.9 in (10 cm)	15.3 in (39 cm)	15 EN 3L	031-305-004	134-130-600	132-305-200	033-300-200
	0.0708 in (1.8 mm)	13.5 oz/mn (400 cc/mn)		3.9 in (10 cm)	16.1 in (41 cm)	18 EN 3L	031-305-005	134-130-700	132-305-200	033-300-200

A29 & A35 AIRCAPS NEEDLES & NOZZLES

NON-MODULAR AUTOMATIC GUNS



PROJECTORS FOR A35 HTI & A29 HTI GUNS

Description	Product viscosity in CA4 (s) or centipoises (cps)	Tip	Fan width at 7.8 in (20cm)		Air consumption	Fluid flow rate	Aircap		Needle	Nozzle	Air cap kit				
		Size	Maximum	Minimum			Type	Part number	Part number	Part number	Part number				
06 E3 K HVLP	< 20	0.023 in (0.6 mm)	0.984 in (25 mm)	3.9 in (10 cm)	11.77 - 17.6 cfm (20 - 30 m³/h)	5.07 oz/mn (150 cc/mn)	E3 K HVLP	132-300-100	033-300-100	134-130-050	031-300-012				
07 E3 K HVLP		0.028 in (0.7 mm)	1.141 in (29 mm)			6.76 oz/mn (200 cc/mn)				134-130-100	031-300-001				
09 E3 K HVLP		0.035 in (0.9 mm)	1.377 in (35 mm)			8.45 oz/mn (250 cc/mn)				134-130-200	031-300-002				
12 E3 K HVLP		0.047 in (1.2 mm)	1.496 in (38 mm)			10.14 oz/mn (300 cc/mn)				134-130-300	031-300-003				
15 E3 K HVLP	20 - 40	0.059 in (1.5 mm)	1.614 in (41 mm)		11.83 oz/mn (350 cc/mn)	12.36 - 17.07 cfm (21 - 29 m³/h)			13.52 oz/mn (400 cc/mn)	EP3	132-300-300	033-300-200	134-130-600	031-300-004	
18 E3 K HVLP		0.071 in (1.8 mm)	1.692 in (43 mm)									5.07 oz/mn (150 cc/mn)	134-130-700	031-300-005	
06 EP3	< 20	0.023 in (0.6 mm)	0.944 in (24 mm)		12.36 - 17.07 cfm (21 - 29 m³/h)	11.83 oz/mn (350 cc/mn)			8.45 oz/mn (250 cc/mn)	EP3	132-300-300	033-300-100	134-130-050	031-300-011	
07 EP3		0.028 in (0.7 mm)	0.984 in (25 mm)										6.76 oz/mn (200 cc/mn)	134-130-100	031-300-006
09 EP3		0.035 in (0.9 mm)	1.22 in (31 mm)										8.45 oz/mn (250 cc/mn)	134-130-200	031-300-007
12 EP3		0.047 in (1.2 mm)	1.259 in (32 mm)										10.14 oz/mn (300 cc/mn)	134-130-300	031-300-008
15 EP3	20 - 40	0.059 in (1.5 mm)	1.338 in (34 mm)	11.83 oz/mn (350 cc/mn)	13.52 oz/mn (400 cc/mn)	11.83 oz/mn (350 cc/mn)	EP3	132-300-300	033-300-200	134-130-600	031-300-009				
18EP3		0.071 in (1.8 mm)	1.496 in (38 mm)						5.07 oz/mn (150 cc/mn)	134-130-700	031-300-010				

PROJECTORS FOR A35 HTI & A29 HPA GUNS

Description	Product viscosity in CA4 (s) or centipoises (cps)	Tip	Fan width at 7.8 in (20 cm)		Air consumption	Fluid flow rate	Aircap		Needle	Nozzle	Air cap kit			
		Size	Minimum	Maximum			Type	Part number	Part number	Part number	Part number			
06 EN 3L	< 20	0.023 in (0.6 mm)	3.9 in (10 cm)	1.18 in (30 mm)	14.12 -25.89 cfm (24 - 44 m³/h)	5.07 oz/mn (150 cc/mn)	EN 3L	132-305-200	033-300-100	134-130-050	031-305-006			
07 EN 3L		0.028 in (0.7 mm)		1.22 in (31 mm)		6.76 oz/mn (200 cc/mn)				134-130-100	031-305-001			
09 EN 3L		0.035 in (0.9 mm)		1.33 in (34 mm)		8.45 oz/mn (250 cc/mn)				134-130-200	031-305-002			
12 EN 3L		0.047 in (1.2 mm)		1.496 in (38 mm)		10.14 oz/mn (300 cc/mn)				134-130-300	031-305-003			
15 EN 3L	20 - 40	0.059 in (1.5 mm)		1.53 in (39 mm)	11.83 oz/mn (350 cc/mn)	13.52 oz/mn (400 cc/mn)			11.83 oz/mn (350 cc/mn)	EP3	132-300-300	033-300-200	134-130-600	031-305-004
18 EN 3L		0.071 in (1.8 mm)		1.61 in (41 mm)								5.07 oz/mn (150 cc/mn)	134-130-700	031-305-005

A28 HPA

Automatic gun with Superlife™ technology (Kremlin Rexson patent) for enamels, high solids and solvent-free materials.

NON-MODULAR AUTOMATIC GUNS



FEATURES	BENEFITS
Patented Superlife™ diaphragm packing (without packings)	Delivers more than 4 - 5 times a standard package operational life
Hardened S/S nozzle with removable polyurethane end needle	Extends the nozzle lifetime and reduced and quick on site maintenance
Separate fan width and atomization air adjustment	Allows for optimum spray pattern and finish quality
Optimized inlet and outlet fluid ports	Optimum spraying of high viscosity materials (circulation recommended to keep product homogeneity)



SPECIFICATIONS	
Maximum air inlet pressure	87 psi (6 bar)
Trigger air pressure	79 psi (5.5 bar) mini
Maximum fluid pressure	45.3 psi (3 bar)
Recommended atomization air pressure	87 psi (6 bar)
Fluid output	Upon tip
Weight	33.7 oz (1050 g)
Maximum fluid temperature	122°F (50°C)
Air consumption	14.1 cfm @ 58 psi (24 m³/h @ 4 bar)
Body of the gun	Stainless steel
Wetted parts	Stainless steel, treated stainless steel, PTFE, elastomer Polyurethane

FITTINGS		
Supply	Gun	Recommended hoses
Fluid	F 3/8" NPS	Ø 10 mm internal
Trigger air	F 1/8" NPS	Ø 6 or 8 mm upon frequency of use
Spraying air	F 1/4" NPS	Ø 10 mm internal



CONFIGURATION OF THE A28 GUN						
Description	Projector	Use	Nozzle Diameter	Fan width	Fluid output	Part number
A28 HPA	-	Gun w/o projector	-	-	-	129-417-000
A28 HPA	207 Z23A	flat pattern	0.027 in (0.7 mm)	7.8-11.8 in (20-30 cm)	3.4 oz/mn (100 cc/mn)	135-417-001
A28 HPA	209 Z23A	flat pattern	0.035 in (0.9 mm)	7.8-11.8 in (20-30 cm)	6.7 oz/mn (200 cc/mn)	135-417-002
A28 HPA	212 Z23A	flat pattern	0.047 in (1.2 mm)	7.8-11.8 in (20-30 cm)	13.5 oz/mn (400 cc/mn)	135-417-003
A28 HPA	212 N23C	flat pattern low pressure	0.047 in (1.2 mm)	7.8-11.8 in (20-30 cm)	13.5 oz/mn (400 cc/mn)	135-417-004
A28 HPA	215 N23C	flat pattern	0.059 in (1.5 mm)	9.8-13.7 in (25-35 cm)	16.9 oz/mn (500 cc/mn)	135-417-005
A28 HPA	218 N23C	flat pattern	0.070 in (1.8 mm)	9.8-13.7 in (25-35 cm)	20.2 oz/mn (600 cc/mn)	135-417-006

PART NUMBER	
Description	Part number
A28, 227 R1	668-417-008
A28, 227 S3	668-417-100

A28 HPA

SEAL KITS

Description	Part number
Seal kit	129-417-900
Repair kit	129-417-901

SUPPORT ACCESSORIES

Description	Part number
Gun mounting support bracket 5/8" 16mm	029-417-011
M5 x 16 Screw	933-011-194
Pin	906-120-089

AIRCAPS FOR A28

Description	Part number
	
Z23A	132-020-550
07N3C	132-021-750
R23	132-021-300
R24	132-021-800
R29	132-021-400
S23	132-021-900
S29	132-021-500

TREATED NOZZLES FOR A28

Description	Part number
	
207T	134-025-050
209T	134-025-100
212T	134-025-200
215T	134-025-300
218T	134-025-400
222T	134-025-600
227T	134-025-700
233T	134-025-800
240T	134-025-900

SPECIFIC NEEDLE FOR A28

Description	Specific needle for A28 (without needle-end)
Dedicated needle (diaphragm assembly)	129-417-910

NEEDLE TIP KIT FOR DEDICATED A28 NEEDLE

Description	Part number
Needle tip kit for nozzles sized 7 to 23 (x10)	129-417-005
Needle tip kit for nozzles sized 33 and 40 (x10)	129-417-014
HDPE needle tip kit for nozzles 15 and 18 (x5)	129-417-020

KITS

Description	Part number
Remote adjusting fan width kit for A26 - A28	029-417-019

A3 HPA

NON-MODULAR AUTOMATIC GUNS



The A3 gun is designed for fine and delicate work. The design allows for easy changes to the width of the fan.

FEATURES	BENEFITS
GL specific projectors mounting	For lines
Optimized inlet and outlet fluid ports	Quick color changes and flushing (recommended circulation to maintain fluid homogeneity)

SPECIFICATIONS	
Maximum air inlet pressure	87 psi (6 bar)
Maximum fluid pressure	87 psi (6 bar)
Trigger air pressure	43 (3 bar)
Recommended atomization air pressure	43 - 72 psi (3 - 5 bar) mini
Fluid flow rate	Upon nozzle selected
Weight	10.2 oz (320 g)
Maximum fluid temperature	122°F (50°C)
Air consumption	11.7 cfm (20 m³/h)
Body of the gun	Aluminum
Wetted parts	Aluminum, stainless steel, treated stainless steel



FITTINGS		
Supply	Gun	Fitting
Fluid	F 1/8" NPS	Not supplied
Control air	F 1/8" NPS	Straight M 1/8" BSP - Hose Ø 4 x 6
Pulverization air	F 1/8" NPS	Not supplied

SUPPORT	
Description	Part number
Mounting support 5/8" Ø16 - (length 3.9 inch)	049-351-200

KITS	
Description	Kit part number
A3 indexed needle adjustment kit (precise output adjustment with indexed positioning)	129-713-050

A3 HPA

AIRCAP
PX
GL



CONFIGURATION

Description	Max fluid viscosity in CA 4	Projector	Nozzle Size	Fan width at 8 inches (20 cm)		Fluid flow rate	Part number w/o base plate
				Minimum	Maximum		
A3 HPA	20 s	08 PX	0.031 in (0.8 mm)	1.2 in (3 cm)	3.9 in (10 cm)	6.7 oz/mn (200 cc/mn)	135-713-014
A3 HPA	20 s	10 PX	0.039 in (1 mm)	1.6 (4 cm)	5.9 in (15 cm)	10.1 oz/mn (300 cc/mn)	135-713-011
A3 HPA	20 s	06 GL	0.023 in (0.6 mm)	0.15 in (0.4 cm)	0.98 in (2.5 cm)	6.1 oz/mn (180 cc/mn)	135-713-017
A3 HPA	20 s	10 GL	0.039 in (1 mm)	0.15 in (0.4 cm)	1.2 in (3 cm)	10.1 oz/mn (300 cc/mn)	135-713-015
A3 HPA	30 s	12 PX	0.047 in (1.2 mm)	1.9 in (5 cm)	5.9 in (15 cm)	15.2 oz/mn (450 cc/mn)	135-713-012

PROJECTORS FOR A3 HPA GUNS

Product viscosity in CA4 (s) or centipoises (cps)	Nozzle Size	Fan width at 8 inches (20 cm)		Fluid flow rate	Air consumption	Description	Projector	Nozzle	Aircap	Needle	
		Minimum	Maximum				Part number	Part number	Part number	Part number	
< 20 s	0.031 in (0.8 mm)	1.2 in (3 cm)	3.9 in (10 cm)	3.4 oz/mn (100 cc/mn)	5.8 cfm (10 m ³ /h)		08 PX	031.713-014	134-630-400	132-631-100	033-713-400
	0.039 in (1 mm)	1.6 (4 cm)	5.9 in (15 cm)	4.1 oz/mn (120 cc/mn)			10 PX	031.713-011	134-630-100	132-631-100	033-713-000
	0.047 in (1.2 mm)	1.9 in (5 cm)	5.9 in (15 cm)	5.1 oz/mn (150 cc/mn)			12 PX	031.713-012	134-630-200	132-631-100	033-713-100
	0.039 in (0.6 mm)	0.15 in (0.4 cm)	.98 in (2.5 cm)	2.7 oz/mn (80 cc/mn)			06 GL	031.713-017	134-640-300	132-640-100	033-713-500
	0.039 in (1 mm)	0.15 in (0.4 cm)	1.8 in (4.6 cm)	4.1 oz/mn (120 cc/mn)			10 GL	031.713-015	134-640-100	132-640-100	033-713-300

PMP-150 PUMP



The PMP-150 diaphragm pump is designed for fluid applications requiring a 1:1 pressure ratio and can be used on some adhesive applications and harsh or high solids, high viscosity coatings.

FEATURES	BENEFITS
Simple design	Easy operation and maintenance
Double diaphragm constructed from PTFE and nitrile	Compatible with most of solvent or water-based products. Quick motor inversion

SPECIFICATIONS

Pressure ratio	1:1
Fluid volume per cycle	3.38 fl oz (100 cm ³)
Number of cycles per 33.8 oz (1 liter) of product	10
Air consumption at 30 cycles/mn at 58 psi (4 bar)	0.65 cfm (1.1 m ³ /h)
Fluid output at 30 cycles/mn	.79 gal/mn (3 L/mn)
Free flow rate	5 gal/mn (19 L/mn)
Maximum air inlet pressure	87 psi (6 bar)
Maximum fluid pressure	87 psi (6 bar)
Maximum fluid temperature	122°F (50°C)
Sound level	<70 dBA
Weight - bare pump	11.2 lbs. (5 kg)
Wetted parts	PTFE, Polypropylene, Stainless steel
Height - wall-mounted	9.4 in (24 cm)
Width - wall-mounted pump	14.1 in (36 cm)
Depth - wall-mounted pump	10.2 in (26 cm)

FITTINGS

Air inlet (valve)	F 3/8"
Air outlet (atomization air)	M 1/4" NPS
Fluid inlet	M 18 x 125
Fluid outlet	M 3/8" NPS



CONFIGURATION OF THE PMP 150 PUMP

Set-up	Air motor power regulator	Atomization air regulator	Air regulator Fluid pressure	Suction rod	Drain rod	Pump output filter	Part number
Bare pump	-	-	-	-	-	-	144-931-000
Wall mounted	●	●	●	-	-	-	151-759-900
Wall mounted	-	●	●	●	-	-	151-751-000
Wall mounted	●	●	●	●	-	-	151-753-000
Wall-mounted with stainless steel circulation	-	●	●	●	-	-	151-757-000

OPTIONS

Description	Can be fitted on	Part number
Fluid pressure air regulator	Wall-mounted and mobile pumps	151-753-010
Stainless steel circulation kit (to be included: wall bracket ref: 056-100-199)	Wall-mounted and mobile pumps	151-757-010
Motor air supply kit	Bare pump	151-753-050

SEAL KITS

Description	Part number
PMP motor seal kit	144-931-091
Fluid section seal kit (PTFE)	144-931-092
Fluid section seal kit (EPDM)	144-931-095
Fluid section seal kit (FPM)	144-931-096

PMP-150 PUMP

FITTING FOR ELECTROSTATIC INSTALLATION (K3 AND SPRAYMIUM)

Description	Part number
Adaptor F 38" NPS/M #5 JIC	050-123-306

CARTS, CUPS AND SUCTION RODS

Description	Part number
0.5 gal (2 L) gravity cup kit with bracket	151-758-100
Tripod for PMP 150	051-755-010
0.5 gal (2 L) gravity cup kit without bracket	151-662-355
Single post cart	051-730-110
Complete wall mounting bracket	051-751-030
Suction rod 18 x 125 fitting - plunger tube length 23.6 in (600 mm)	049-596-010

PART NUMBER

Description	Part number
System, PMP-150, wall mount, c/w 3 regs, M22 12E3, 5 gallon rod	668-751-000
System, PMP-150, wall mount, c/w 3 regs, M22 12E3, 55 gallon rod	668-751-001
System, PMP-150, wall mount, 3 regs, glue gun kit, 5 gallon rod, M22 15EN2	668-751-004
PMP-150, wall mount, c/w pump air regulator, 5 gallon rod	668-751-009
PMP-150, wall mount, c/w pump air regulator, 55 gallon rod	668-751-011
PMP-150, wall mount, c/w pump air reg, circulation kit, 5 gallon rod	668-751-015
PMP-150, p/m, c/w 3 regs agitator	668-751-021
System, PMP-150, p/m, c/w 3 regs M22 12E3, agitator	668-751-023
PMP-150, c/w muffler, mounting bracket	668-931-000

PMP-150E PUMP

AIRSPRAY PUMPS



The PMP-150E diaphragm pump is a packing free pump designed with special balls and seats to pump abrasive water-based coatings such as porcelain enamel.

FEATURES	BENEFITS
Simple and rugged design	Compatible with a wide range of materials
Compact design	Long lasting performance
Charged polypropylene diaphragm and polyurethane balls	Compatible with water-based and enamels

SPECIFICATIONS	
Pressure ratio	1:1
Fluid volume per cycle	3.38 fl oz (100 cm ³)
Number of cycles per 33.8 oz (1 liter) of product	10
Air consumption at 30 cycles/mn at 58 psi (4 bar)	.65 cfm (1.1 m ³ /h)
Fluid output at 30 cycles/mn	.79 gal/mn (3 L/mn)
Free flow rate	5 gal/mn (19 L/mn)
Maximum air inlet pressure	87 psi (6 bar)
Maximum fluid pressure	87 psi (6 bar)
Maximum fluid temperature	122°F (50°C)
Sound level	<70 dBA
Weight - bare pump	11 lbs (5 kg)
Diaphragm material	Polyurethane
Wetted parts	Polypropylene, PTFE, Polyurethane
Height	8.6 in (22 cm)
Width	7.8 in (20 cm)
Depth	5.9 in (15 cm)



FITTINGS	
Air inlet	F 3/8"
Fluid inlet	F 3/8" BSP
Fluid outlet	F 3/8" BSP

CONFIGURATION OF THE PMP 150E PUMP						
Set-up	Suction rod	Drain rod	Atomization air regulator	Air regulator Fluid pressure	Pump output filter	Part number
Bare	-	-	-	-	-	144-932-000

OPTIONS	
Description	Part number
Motor air supply kit	151-753-050

SEAL PACKS	
Description	Part number
PMP motor seal kit	144-931-091
Fluid section seal kit (PTFE)	144-931-092

CARTS, CUPS AND SUCTION RODS	
Description	Part number
Tripod for PMP 150	051-755-010
2 liter gravity cup kit with bracket	151-758-100
2 liter gravity cup kit without bracket	151-662-355
Single post cart	051-730-110
Complete wall mounting bracket	051-751-030

PMP-150 TRANSFER PUMP



The PMP-150 diaphragm pump is designed for fluid transfer applications.

FEATURES	BENEFITS
Double material diaphragm constructed from PTFE and nitrile	Compatible with most of solvent or water-based products. Quick motor inversion
Simple design	Easy operation and maintenance

SPECIFICATIONS	
Pressure ratio	1:1
Fluid volume per cycle	3.38 fl oz (100 cm ³)
Number of cycles per 33.8 oz (1 liter) of product	10
Air consumption at 30 cycles/mn at 58 psi (4 bar)	.65 cfm (1.1 m ³ /h)
Fluid output at 30 cycles/mn	.79 gal/mn (3 L/mn)
Free flow rate	5 gal/mn (19 L/mn)
Maximum air inlet pressure	87 psi (6 bar)
Maximum fluid pressure	87 psi (6 bar)
Maximum fluid temperature	122°F (50°C)
Sound level	<70 dBA
Weight - bare pump	7.4
Wetted parts	PTFE, Polypropylene, Stainless steel
Height	8.6 in (22 cm)
Width	7.8 in (20 cm)
Depth	5.9 in (15 cm)

FITTINGS	
Air inlet (valve)	F 3/8"
Fluid inlet	F 3/4" NPS
Fluid outlet	F 3/8" BSP



CONFIGURATION OF THE PMP 150 PUMP							
Set-up	Air motor power regulator	Air regulator Fluid pressure	Fluid pressure regulator	Suction rod	Drain rod	Pump output filter	Part number
Bare transfer PMP 150 pump	●	-	-	-	-	-	151-752-500

OPTION	
Description	Part number
Motor air supply kit	151-753-050

SEAL KITS	
Description	Part number
PMP motor seal kit	144-931-091
Fluid section seal kit (PTFE)	144-931-092

02.75 PUMP



The 02.75 piston pump is designed for use with a single or multiple gun systems spraying medium viscosity coatings. It can also be used on a heated circulation system.

FEATURES	BENEFITS
Compact design	Easily integrated into a finish workshop
Rugged - High sealing capacity with single lip seal	Compatible with a wide range of materials
Available in stainless steel version	Compatible with water-based materials

SPECIFICATIONS		
Pressure ratio	1.8:1	
Fluid volume per cycle	2.87 fl oz (85 cm ³)	
Number of cycles per 33.8 oz (1 liter) of product	12	
Air consumption at 30 cycles/mn at 58 psi (4 bar)	1.2 cfm (2.1 m ³ /h)	
Fluid output at 30 cycles/mn	.7 gal/mn (2.6 L/mn)	
Free flow rate	1.3 gal/mn (5.1 L/mn)	
Maximum air inlet pressure	87 psi (6 bar)	
Maximum fluid pressure	145 psi (10 bar)	
Maximum fluid temperature	140 °F (60°C)	
Sound level	81 dBA	
Sealing packings	Upper sealing	GT cartridge with polyethylene packing
	Lower sealing	Acetal resin seal
Weight - bare pump	11 lbs. (5 kg)	
Wetted parts	Aluminum, stainless steel	
Height	16.1 in (41 cm)	
Width - 2 regulators	11 in (28 cm)	
Depth	6.7 in (17 cm)	

FITTINGS	
Air inlet (valve)	F 3/8"
Air outlet (atomization air)	M 1/4" NPS
Fluid inlet	M 18x125
Fluid outlet	M 3/8" NPS



CONFIGURATION OF THE 02.75 PUMP

Set-up	Additional regulator	Atomization air regulator	Air regulator Fluid pressure	Suction rod	Drain rod	Pump output filter	Part number
Standard, bare	-	-	-	-	-	-	144-941-000
Bare, stainless steel	-	-	-	-	-	-	144-940-000
Wall-mounted, stainless steel with 2 air regulator and 1 fluid regulator	●	●	●	●	-	-	151-761-400

PART NUMBER

Description	Part number
Pump, 02-75, s/s, w/m, c/w pump air reg, 5 gallon rod	668-761-204
Pump, 02-75, s/s, w/m, c/w pump air reg, bottle, 5 gallon rod	668-761-205
Pump, 02-75, s/s, w/m, c/w pump reg, w/o suction	668-761-207
System, 02-75, w/m, c/w, 3 regs, M22 12E3, 5 gallon rod	668-763-200

02.75 PUMP

SEAL KITS

Description	Part number
Seal kit for 75 fluid section	144-941-490
Repair kit for 75 fluid section	144-941-495
Seal kit for 340-2 air motor	144-850-150

FITTING FOR ELECTROSTATIC INSTALLATION (K3 AND SPRAYMIUM)

Description	Part number
Adaptors F 38"NPS/M #5 JIC	050-123-306

CARTS AND SUCTION RODS

Description	Part number
Single post cart	051-730-110
Suction rod 18 x 125 fitting - plunger tube length 600 mm	049-596-010

PRESSURE POTS

PRESSURE POTS



2.5 Gallon pressure pots

The 2.5 gallon (11 Liter) Non-ASME pressure pot is designed to feed most coatings in pressure feed applications.

FEATURES	BENEFITS
Solvent resistant glass on gauges	Easy to clean and view without distortion
Aluminum cup construction (2 quart cup)	Lightweight and easy to handle
Stainless steel fluid passages (2.5 gallon pot)	Compatible with most coatings
Anti-stick PTFE coating (2.5 gallon pot)	Easy to clean and maintain

SPECIFICATIONS			
Description	2 quart cup	2.5 gallon pot	2.5 gallon pot with agitator
Capacity	2.5 quarts / (2.75 L)	2.5 gallons / (11 L)	
Material	Forged aluminum		
Diameter	5 1/8" / (13 cm)	11 3/8" / (29cm)	
Height (cup/pot only)	8 3/4" / (22.2 cm)	10 1/2" / (26.7 cm)	
Number of clamps	screw on lid 4		
Weight	2.5 lbs. (1.3 kg)	32 lbs. (14.5 kg)	36.5 lbs. (16.5 kg)
Number of handles	1	1	1
Removable aluminum liner	No	2.5 gallons / (11 L)	
Maximum inlet pressure	50 psi / (3.5 bar)	80 psi / (6 bar)	
Maximum temperature	122°F / (50°C)		
Air regulator (s)	1	1 or 2	
Number of fluid outputs	1 upper		
Agitator	No	No	Yes

FITTINGS			
Hose connection	2 quart cup	2.5 gallon pot	2.5 gallon pot with agitator
Fitting	Air inlet 1/4NPSM	1/4NPSM	3/8NPTM
	Fluid outlet 3/8NPSM	3/8NPSM	3/8NPSM

CONFIGURATION OF 2.5 GALLON PRESSURE POT AGITATORS					
Description	Pot regulator	Atomization regulator	Agitator	Part number	
2.5 gallon pressure pot c/w dual regulator	Yes	Yes	-	668-222-140	
2.5 gallon pressure pot c/w single regulator	Yes	-	-	668-222-145	
2.5 gallon pressure pot c/w agitator, dual regulator	Yes	Yes	Yes	668-222-150	
2.5 gallon pressure pot c/w agitator, single regulator	Yes	-	Yes	668-222-155	

SYSTEM PART NUMBERS	
Description	Part number
System, 2.5 gallon pot, c/w M22 BasiK, 12BA3	668-222-011
System, 2.5 gallon pot, c/w M22 15EN3	668-222-012
System, 2.5 gallon pot, c/w M22 12EP3	668-222-013
System, 2.5 gallon pot, c/w M22 12E3	668-222-014
System, 2.5 gallon pot, c/w M22B glue gun kit	668-222-015
System, 2.5 gallon pot, c/w M22B 12BA3, agitator	668-222-021
System, 2.5 gallon pot, c/w M22 15EN3, agitator	668-222-022
System, 2.5 gallon pot, c/w M22 12E3, agitator	668-222-024
System, 2.5 gallon pot, c/w S3A 08ESG KHVLP	668-222-201
System, 2.5 gallon pot, c/w S3A 15ESG KHVLP	668-222-204
System, 2.5 gallon pot, c/w S3P 12ESG, agitator	668-222-303
System, 2.5 gallon pot, c/w M22 HTVP 18/04, 25ft hose	668-222-440
System, 2.5 gallon pot, c/w M22 HTVP 18/05, 25ft hose	668-222-441
System, 2.5 gallon pot, c/w M22 HTVP 22/06, 25ft hose	668-222-442
System, 2.5 gallon pot, c/w M22 HPAP, 15EG1, glue gun kit	668-222-600



PRESSURE CUPS

PRESSURE POTS



2 Quart pressure cup

The 2 quart pressure cup is great for small batch jobs and fast color changes.



2 QUART PRESSURE CUP	
Description	Part number
2 quart pressure cup c/w gauge	668-222-000

MAINTENANCE PARTS	
Description	Part number
Lid gasket for 2 quart cup	668-222-030
Lid gasket for 2 gallon pot	668-222-031

PART NUMBER	
Description	Part number
System, 2 quart, M22 12EN3, c/w 5ft hose kit	668-222-002
System, 2 quart, M22 12EP3, c/w 5ft hose kit	668-222-003
System, 2 quart, c/w M22 12E3 5ft hose kit	668-222-004
System, 2 quart, c/w M22 12E3 10ft hose kit	668-222-700



AD 60/61 HEATERS

EXPLOSION PROOF



Original design ensuring optimum heat transfer with no risk of burning the paint in the heater.

By adding heat, viscosity is reduced. Lower viscosity means atomization pressures can be reduced. The result is higher transfer efficiency and a more consistent finish.

Reduces paint viscosity without dilution.

To be used in zone 1 and 2 according to ATEX.

Agreement INERIS 03ATEX 0079X

 II 2 G EEx d IIA T3



FEATURES	BENEFITS
A thermometer is integrated into the command box	No pressure loss when working with high viscosity materials
Modular design	Easy maintenance
Available in stainless steel version	Compatible with water-based materials
Fluid body and fittings	Stainless steel

SPECIFICATIONS	
Thermostat type	By fluid extension and dry contact
Thermal fuse	Cut at 249.8°F (121°C)
Thermometer	Graduation 32 - 249.8°F (0 - 100°C)
Temperature range	59 - 176°F (15 - 80°C)
Pressure	3480 psi (240 bar) maxi
Weight	Aluminum: 34.1 lbs (15.5 kg) Stainless steel: 55.1 lbs (25 kg)
Wetted parts	Aluminum: aluminum body, galvanized chrome fittings Stainless steel: stainless steel body and fittings
Room temperature	104°F (40°C) maxi







* When used in accordance with the specifications stated in the operating manual. If the paint does not circulate properly or the unit malfunctions the paint could be damaged by over heating.

AD HEATERS - ALUMINUM VERSION (SOLVENT-BASED MATERIALS)

Aluminum heater	Voltage / Power		Temperature	Cable length w/o plug	Fitting		Part number
	Volt	Watt			Inlet	Outlet	
AD60 	230	1500	59 - 176°F (15 - 80°C)	32.8 feet (10 m)	#5 JIC	#5 JIC	056-126-000
AD61 	115	1500	59 - 176°F (15 - 80°C)	16.4 feet (5 m)	#5 JIC	#5 JIC	056-126-050

AD HEATERS - STAINLESS STEEL VERSIONS (SOLVENT OR WATER-BASED MATERIALS)

Stainless steel heater	Voltage / Power		Temperature	Cable length w/o plug	Fitting		Part number
	Volt	Watt			Inlet	Outlet	
AD60 	230	1500	59 - 176°F (15 - 80°C)	32.8 feet (10 m)	#5 JIC	#5 JIC	056-146-000
AD61 	115	1500	59 - 176°F (15 - 80°C)	16.4 feet (5 m)	#5 JIC	#5 JIC	056-146-050
AD60 	400	1250	59 - 176°F (15 - 80°C)	16.4 feet (5 m)	#5 JIC	#5 JIC	056-146-070
AD60 	480	1500	59 - 176°F (15 - 80°C)	16.4 feet (5 m)	#5 JIC	#5 JIC	156-145-200

ONE-PASS™ HEATER

EXPLOSION PROOF



The economical and reliable solution for a consistent spraying quality by reducing the viscosity of paints without adding solvents. The heating of the product is done in one single passage in the One-Pass™ Heater thanks to the new design and the optimized thermal exchange efficiency.

This innovative design offers the possibility to install the One-Pass™ Heater directly between the pump and the gun without recirculation. Its dimensions and reduced weight allow to fit on a mobile pump (2 arms cart and mounting plate)



To be used in zone 1 and 2 according to ATEX

Agreement ISSeP 05ATEX031
 II 2 G Ex d IIA T3



FEATURES	BENEFITS
Standard stainless steel version	Compatible with water-based materials
A thermal tape is on the body of the paint circuit	No pressure loss when working with high viscosity materials
Reduced dimensions	Cart mounting
Modular design	Quick and easy maintenance
t max: 68°F (20°C) at an output of 27.05 oz/mn (800 cc/mn)	Optimized performances in most applications
Cart mount	Easy mobility

SPECIFICATIONS	
Thermostat type	By fluid expansion and dry contact
Thermal fuse	Cut at 161.6°F (72°C)
Thermometer	Graduation 32 - 140°F (0 - 60°C)
Temperature range	68-104°F (20-40°C)
Pressure	1740 psi (120 bar)
Weight	36.4 lbs (16.5 kg)
Wetted parts	Stainless steel and PTFE
Room temperature	104°F (40° bar) maxi
Flow rate	max 27.05 oz/mn (800 cc/mn)

ONE PASS  HEATER PART NUMBERS							
Stainless steel One-pass heater	Voltage / Power		Temperature	Cable length w/o plug	Fitting		Part number
	Volt	Watt			Inlet	Outlet	
One-pass  115V	115	1400	68-104°F (20-40°C)	16.4 feet (5 m)	#5 JIC	#5 JIC	056-151-110
One-pass  230V	230	1400	68-104°F (20-40°C)	16.4 feet (5 m)	#5 JIC	#5 JIC	056-152-110

■ Circulation valve SS

Allows you to set the perfect output for circulation.
Max. fluid pressure: 3480 psi (240 bar.)

CIRCULATION VALVES PART NUMBERS (NON STAINLESS STEEL)					
Thread	Rod	Back fitting	Flushing valve	Flushing rod M 18 x 125	Part number
Pump intake F 26 x 125	M 26 x 125	#5 JIC	●	●	668-000-028



■ Y-fitting for one additional gun supply

Fluid circuit: remove the plug of the second fluid filter outlet and connect the elbow fitting.
Air circuit: add the Y-fitting to the outlet of the air regulator on the pump.

TWO-GUN SYSTEM		
Description	Material	Part number
Fluid Y-fitting #5 JIC	Stainless steel	029-520-500



CTM COLOR CHANGE VALVES

AIRSPRAY CIRCULATING



Recommended for a rapid color change, without the need to manipulate any fluid. At the same time, you will reduce costs through less down time and lower solvent consumption.

The solvent valve should be opposite the fluid outlet.

- Two valves per module
- PTFE seals
- Modular design allows for expansion
- Paint circulation through the valve
- Opening index as standard



CTM VALVE SPECIFICATIONS

Description	Conventional
Max pressure	116 psi (8 bar)
Ø of passage	5/16" (8 mm)
Trigger air	for hose 2,7 × 4
Fluid inlet	F 1/4 NPS
Fluid outlet	F 1/4 NPS

ACCESSORIES

Description	Part number
Conventional Inlet module (product and solvent inlet)	155-535-100
Conventional Intermediate module (product inlet)	155-535-200
Conventional Outlet flange (product outlet)	155-535-500
Assembly module rods C/w outlet module: ⁽¹⁾	Assembly module rod (pack of 2) C/w outlet module:
	1 module (1 inlet module + 1 outlet flange)
	2 modules (1 inlet module + 1 intermediate module + 1 outlet flange)
	3 modules (1 inlet module + 2 intermediate modules + 1 outlet flange)
	4 modules (1 inlet module + 3 intermediate modules + 1 outlet flange)
	5 modules (1 inlet module + 4 intermediate modules + 1 outlet flange)
	Assembly of 2 fixing squares
	155-535-610
	155-535-620
	155-535-630
	155-535-640
	155-535-650
	155-535-700

(1) Each module is equipped with a nut and a washer, the head of the screw must be placed on the outlet flange side.

PDM 01.175 PUMP

AIRSPRAY CIRCULATING



For low pressure circulation loops, the PDM 01.175 is the best choice. This pump is found in a multitude of applications throughout the world for medium to large factories that have dedicated colors in the wood, metal and plastic industries.

FEATURES	BENEFITS
Simple design	Easy operation and maintenance
Diaphragm made of PTFE	Compatible with most water-based materials
Compact design	Makes it easy to have multiple pumps in a small paint kitchen room

SPECIFICATIONS	
Pressure ratio	1:1
Fluid volume per cycle	11.83 fl oz (350 cm ³)
Number of cycles per 33.8 oz (1 liter) of product	3
Fluid output at 30 cycles/mn	2.8 gal/mn (10.5 L/mn)
Free flow rate	10 gal/mn (38 L/mn)
Maximum air inlet pressure	87 psi (6 bar)
Maximum fluid pressure	87 psi (6 bar)
Maximum fluid temperature	122°F (50°C)
Sound level	<70 dBA
Weight - wall-mounted	28.6 lbs. (13 kg)
Wetted parts	PTFE, Stainless steel, Aluminum
Height	11.4 in (29 cm)
Width	9.6 in (24.5 cm)
Depth	12.4 in (31.5 cm)

FITTINGS	
Air inlet	F 3/8" BSP
Fluid inlet	M 26 x 125
Fluid outlet	F 1/2" NPS



CONFIGURATION OF THE PDM 01.175 PUMP

Set-up	Suction rod	Drain rod	Atomization air regulator	Air regulator Fluid pressure	Pump output filter	Part number
Bare pump	-	-	-	-	-	144-905-000
Wall mounted pump	●	-	-	●	-	151-656-000

SUCTION RODS

Description	Part number
Easyflow suction rod, 5 gal	149-596-150
Easyflow suction rod, 55 gal	149-596-160

PART NUMBER

Description	Part number
Pump, PDM 01-175, w/m, 55 gallon rod	668-656-100



04.120 PUMP

AIRSPRAY CIRCULATING



For medium viscosity products with 1 or more guns. For circulating and automatic machines.

FEATURES	BENEFITS
Stainless steel construction	Compatible with water-based materials
Large fluid section	Reduces the amount of shearing on the coating
Durable construction	Provides dependability and performance

SPECIFICATIONS		
Pressure ratio	4:1	
Fluid volume per cycle	8.11 fl oz (240 cm ³)	
Number of cycles per 33.8 oz (1 liter) of product	4	
Fluid output at 30 cycles/mn	1.9 gal/mn (7.2 L/mn)	
Air Consumption @ 30 CPM at 72 psi (5 bar)	6.1 cfm (10.3 m ³ /h)	
Free flow rate	3.8 gal/mn (14.4 L/mn)	
Maximum air inlet pressure	87 psi (6 bar)	
Maximum fluid pressure	348 psi (24 bar)	
Maximum fluid temperature	140°F (60°C)	
Sound level	80 dBA	
Sealing packings	Upper sealing	PTFE G + Polyfluid
	Lower sealing	HDPE
Weight - wall-mounted	59.5 lbs. (27 kg)	
Wetted parts	Stainless steel	
Height	32.6 in (83 cm)	
Width	15.8 in (40 cm)	
Depth	8.3 in (21 cm)	

FITTINGS	
Air inlet	F 3/4 BSP
Fluid inlet	M 26x125
Fluid outlet	#5 JIC



CONFIGURATION OF THE 04.120 PUMP

Set-up	Suction rod	Drain rod	Atomization air regulator	Air regulator Fluid pressure	Pump output filter	Part number
Bare	-	-	-	-	-	151-792-000
Wall-mounted	-	-	-	●	-	151-792-100
Wall-mounted	●	●	-	●	●	151-792-200
Cart-mounted	●	●	-	●	●	151-792-400

PART NUMBER

Description	Part number
Pump, 04-120 w/m, c/w pump air reg, filter, 5 gal, wb abrasive kt	668-792-117
Pump, 04-120, w/m, c/w air reg, 55 gal. rod, filter, GT cartridge	668-792-112
Pump, 04-120, w/m, c/w pump air reg, filter, w/o suction	668-792-100
Pump, 04-120, w/m, c/w pump air reg, 55 gal. rod, filter	668-792-102
Pump, 04-120, w/m, c/w pump air reg, 5 gal. rod, w/o filter	668-792-103
Pump, 04-120, w/m, c/w pump air reg, 55 gal. rod, w/o filter	668-792-104

KITS

Description	Part number
Seal kit H120	144-970-090
Repair kit H120	144-970-095
Seal kit for 500-4 air motor	146-260-990
Repair kit for 500-4 air motor	146-260-995

CARTS AND RODS (SUCTION AND FLUSHING)

Description	Part number
Two post cart w/o plate	051-221-000
Two post pump mounting plate	056-100-199
Easyflow suction rod, 5 gal	149-596-150
Easyflow suction rod Ø25 plunging tube length 39.4 in (1000 mm) for 55 gal (200 liters drums)	149-596-160
Stainless steel flushing rod F18 x 125	049-596-000

04.120F FLOWMAX® PUMP

AIRSPRAY CIRCULATING



Bellows pump - Flowmax® technology - without packings for automatic machines and circulating

FEATURES	BENEFITS
Sealing done by one large stroke Bellows	High reliability No more lubricant cups Leak free Fluid section isolated from atmosphere Ideal to work with moisture-sensitive catalysts Ideal for UV and pre-catalyzed materials
Ergonomic design of fluid passages	Fluid discharge without retention of a wide range of coating materials
Stainless steel construction	Compatible with water-based materials
Balanced fluid section	Constant fluid output pressure
Mobile piston seal	Excellent suction capacity

SPECIFICATIONS		
Pressure ratio	4: 1	
Fluid volume per cycle	8.11 fl oz (240 cm ³)	
Number of cycles per 33.8 oz (1 liter) of product	4	
Fluid output at 30 Cycles/mn	1.9 gal/mn (7.2 L/mn)	
Free flow rate	3.8 gal/mn (14.4 L/mn)	
Air Consumption @ 30 CPM at 72 psi (5 bar)	6.1 cfm (10.3 m ³ /h)	
Maximum air inlet pressure	87 psi (6 bar)	
Maximum fluid pressure	348 psi (24 bar)	
Maximum fluid temperature	122°F (50°C)	
Sound level	< 82 dBA	
Sealing packing	Bellows	Polyethylene
	Upper and lower	GT polyethylene
Wetted parts	Stainless steel	
Weight	59.5 lbs. (27 kg)	
Height	40.9 in (104 cm)	
Width	15.7 in (40 cm)	
Depth	8.3 in (21 cm)	

FITTINGS	
Air inlet	F 3/4" BSP
Fluid inlet	M 26 x 125
Fluid outlet	M 3/8" NPS



CONFIGURATION OF THE FLOWMAX® 04.120F PUMP						
Set-up	Drain rod	Suction rod	Atomization air regulator	Air regulator Fluid pressure	Pump output filter	Part number
Bare	-	-	-	-	-	151-795-000
Wall-mounted	-	-	-	●	-	151-795-100
Wall-mounted	●	●	-	●	●	151-795-200
Cart-mounted	●	●	-	●	●	151-795-400

PART NUMBER	
Description	Part number
Pump, 04-120F, w/m, c/w pump air reg, filter, w/o suction	668-795-100
Pump, 04-120F, w/m, c/w pump air reg, 55 gal. rod, filter	668-795-102
Pump, 04-120F, w/m, c/w pump air reg, 5 gal rod, w/o filter	668-795-103
Pump, 04-120F, w/m, c/w pump air reg, 55 gallon rod, w/o filter	668-795-104
Pump, 04-120FPH, c/w pump air reg filter, 5 gallon rod	668-795-109
Pump, 04-120FPH, c/w pump air reg filter, 55 gallon rod	668-795-110

CARTS AND RODS (SUCTION AND FLUSHING)	
Description	Part number
Two post cart w/o plate	051-221-000
Two post pump mounting plate	056-100-199
Easyflow suction rod, 5 gal	149-596-150
Easyflow suction rod, 55 gal	149-596-160
Stainless steel flushing rod F18 x 125	049-596-000



04.220FT FLOWMAX[®]

TURBO PUMP

High output, cartridge free Bellows pump for circulating and automatic machines. The Turbo air motor is provided for long smooth pumping

FEATURES	BENEFITS
Sealing done by one large stroke Bellows	High reliability No more lubricant cups Leak free Fluid section isolated from atmosphere Ideal to work with moisture-sensitive catalysts Ideal for UV and pre-catalyzed materials
Ergonomic design of fluid passages	Fluid discharge without retention of a wide range of coating materials
Stainless steel construction	Compatible with water-based materials
Balanced fluid section	Constant fluid output pressure
Mobile piston seal	Excellent suction capacity

SPECIFICATIONS	
Pressure ratio	4:1
Fluid volume per cycle	14.88 fl oz (440 cm ³)
Number of cycles per 33.8 oz (1 liter) of product	2.3
Fluid output at 20 Cycles/mn	2.3 gal/mn (8.8 L/mn)
Free flow rate	6.9 gal/mn (26.4 L/mn)
Air Consumption @ 20 CPM at 72 psi (5 bar)	7.4 cfm (12.7 m ³ /h)
Maximum fluid pressure	348 psi (24 bar)
Maximum fluid temperature	122°F (50°C)
Maximum air inlet pressure	87 psi (6 bar)
Sound level	78 dBA
Sealing packing	Bellows Upper and lower
	Polyethylene GT Polyethylene
Wetted parts	Hard chrome stainless steel, stainless steel and carbide
Weight	114 lbs. (52 kg)
Height	43.3 in (110 cm)
Width	14.9 in (38 cm)
Depth	10.8 in (27.5 cm)

FITTINGS	
Air inlet	F 3/4" BSP
Fluid inlet	F 3/4" BSP
Fluid outlet	F 3/4" BSP

CONFIGURATION OF THE FLOWMAX [®] 04.220F PUMP						
Set-up	Suction rod	Drain rod	Atomization air regulator	Air regulator Fluid pressure	Pump output filter	Part number
Wall-mounted	-	-	-	●	-	151-862-200
Turbo wall-mounted	-	-	-	●	-	151-863-200

PART NUMBER	
Description	Part number
Pump, 04-220F, w/m, c/w 55 gallon rod	668-862-104
Pump, 04-220F, w/m, c/w filter 55 gallon rod	668-862-102
Pump, 04-220F, w/m, c/w filter, w/o suction	668-862-100

CARTS, FILTER AND RODS (SUCTION AND FLUSHING)	
Description	Part number
Two reinforced arms w/o mounting plate	051-231-000
Suction rod Ø25 plunging tube length 23.6 in (600 mm)	049-597-100
Stainless steel Accumulator equipped filter 3/4"	155-581-400
Stainless steel flushing rod F18 x 125	049-596-000





EOS 03-R440

The concept of the new EOS "R" range is to solve common issues of 24/7 paint circulating systems. The EOS "R" pumps feature a bellow technology and a state of the art lubricant circulating system.

The piston of the pump is continuously cleaned with pressurized lubricant. This extends the life cycle of the pump and reduces maintenance to a minimum.

Associated with the KREMLIN REXSON air motor and a divorced fluid section, the EOS "R" pumps are "best in class" for endurance and fast maintenance.

FEATURES	BENEFITS
Small fluid section and suction rod	Less product loss during color-changing and pump flushing
The gun/pump kits work with a compressor of 0.5 HP	Reduction of operational costs
Simple design , reduced number of spare parts	Easy maintenance
Compact design	Fits in small working areas

SPECIFICATIONS	
Pressure ratio	3:1
Output per cycle (cc)	440
Maximum material pressure	261 psi (18 bar)
Material flow at 20 cycles/min	2.3 gal/min (8.8 L/min)
Maximum working temperature	122 °F (50°C)
Air working pressure	29 - 87 psi (2 - 6 bar)
Air consumption @30 PSI	0.2 CFM/cycle 90.34 m ³ /h/cycle
Fluid outlet	F 3/4" NPS
Air inlet	F 3/4" BSP
Fluid inlet	F 1" NPS
Sound level (dBa)	68.4
Weight	116 lbs. (52.8 kg)



CONFIGURATION OF THE EOS 03-R440

Set-up	Part number
PUMP, 03-R440, W/M, W/O FILTER	151-866-100
PUMP, 03-R440, W/M, W/O FILTER, WATERBASED, PU SEALS	151-866-300

Description	Part number
PACK OF SEALS, WATER-BASE (POLYURETHANE)	144-990-130
SERVICE KIT, WATER-BASE (POLYURETHANE)	144-990-695
PACK OF SEALS, GT SEAL, UHMW	144-990-090
SERVICE KIT, GT SEAL, UHMW	144-990-595
SEALS KIT, AIR MOTOR	105-836
PNEUMATIC VALVES, KIT	146-320-094



EOS 06-R440

The concept of the new EOS "R" range is to solve common issues of 24/7 paint circulating systems. The EOS "R" pumps feature a bellow technology and a state of the art lubricant circulating system.

The piston of the pump is continuously cleaned with pressurized lubricant. This extends the life cycle of the pump and reduces maintenance to a minimum.

Associated with the KREMLIN REXSON air motor and a divorced fluid section, the EOS "R" pumps are "best in class" for endurance and fast maintenance.



FEATURES	BENEFITS
Small fluid section and suction rod	Less product loss during color-changing and pump flushing
The gun/pump kits work with a compressor of 0.5 HP	Reduction of operational costs
Simple design , reduced number of spare parts	Easy maintenance
Compact design	Fits in small working areas

SPECIFICATIONS	
Pressure ratio	6:1
Output per cycle (cc)	440
Maximum material pressure	522 psi (36 bar)
Material flow at 20 cycles/min	2.3 gal/min (8.8 L/min)
Maximum working temperature	122 °F (50°C)
Air working pressure	29 - 87 psi (2 - 6 bar)
Air consumption @30 PSI	0.33 CFM/cycle (0.56. m³h/cycle)
Fluid outlet	F 3/4" NPS
Air inlet	F 3/4" BSP
Fluid inlet	F 1" NPS
Sound level (dBA)	68.4
Weight	121 lbs. (55 kg)

CONFIGURATION OF THE EOS 06-R440

Set-up	Part number
PUMP, 06-R440, W/M, W/O FILTER	151-864-100
PUMP, 06-R440, W/M, W/O FILTER, WATERBASED, PU SEALS	151-864-400

SEAL KIT

Description	Part number
PACK OF SEALS, WATER-BASE (POLYURETHANE)	144-990-130
SERVCE KIT, WATER-BASE (POLYURETHANE)	144-990-695
PACK OF SEALS, GT SEAL, UHMW	144-990-090
SERVCE KIT, GT SEAL, UHMW	144-990-595
SEALS KIT, AIR MOTOR	146-310-090
PNUEMATIC VALVES, KIT	146-320-094

■ Pressure regulator - Low pressure manual control

Made entirely out of stainless steel, easy to flush.

CHARACTERISTICS		
Pressure range	Inlet	580 psi (40 bar) max.
	Outlet (upon version)	7.2 - 58 psi (0.5 - 4 bar)
Weight		2.8 lbs. (1.3 kg)
Width		3.3 in (8.5 cm)
Height	Large passages	6.7 in (17 cm)
	Small passage	6.4 in (16.5 cm)
Wetted parts		Stainless steel, PTFE, carbide

REGULATOR FITTINGS LARGE PASSAGE		
Fitting	Fluid inlet (w/o adaptor)	M 1/4 BSP
	Fluid outlet	F 1/4 BSP (x2)

REGULATOR FITTINGS SMALL PASSAGE		
Fitting	Fluid inlet	F 1/4 NPS
	Fluid outlet	F 1/4 BSP (x2)

CONFIGURATION		
Description	Gauge	Part number
Bare pressure regulator PP (small passage)	-	155-610-200
Pressure regulator PP (small passage)	●	155-610-209
Bare pressure regulator GP (large passage) - charged materials	-	155-610-250
Pressure regulator GP (large passage) - charged materials	●	155-610-259



■ Pressure regulator - Piloted low pressure

Available in stainless steel or non-stick treated versions, excellent flushing.
Manual control version available for a very fine regulation and even flow.

CHARACTERISTICS			
Part number	055-370-100		
Pressure range	Inlet	Small passage	580 psi (40 bar) max.
		Large passage	87 psi (6 bar) max
		Manual command	145 psi (10 bar) max
	Outlet	7.2 - 58 psi (0.5 - 4 bar)	
	Command air	87 psi (6 bar) max	
Wetted parts	Stainless steel, PTFE, carbide		

SMALL PASSAGE REGULATOR - FITTINGS AND DIMENSIONS		
Fitting	Fluid inlet	F 1/4" NPS
	Fluid outlet	F 1/4" BSP
	Air inlet (command)	F 1/8" BSP
Weight		2.2 lbs. (1 kg)
Width		3.3 in (8.5 cm)
Height		2.9 in (7.3 cm)

LARGE PASSAGE REGULATOR - FITTINGS AND DIMENSIONS		
Fitting	Fluid inlet	M 1/4" BSP + (M18x125, M3/8" NPS, M3/8"BSP)
	Fluid outlet	F 1/4 BSP
	Air inlet (command)	F 1/8 BSP
Weight		2.2 lbs. (1 kg)
Width		2.9 in (7.3 cm)
Height		3.3 in (8.5 cm)



Piloted regulator

■ Pressure regulator - Piloted low pressure (continued)

MANUAL CONTROL PILOTED REGULATOR - FITTINGS AND DIMENSIONS		
Fitting	Fluid inlet	M 1/4" BSP + (M18x125, M3/8" NPS, M3/8"BSP)
	Fluid outlet	F 1/4" BSP
Weight	3.5 lbs. (1.6 kg)	
Width	7.8 in (20 cm)	
Height	3.3 in (8.5 cm)	

CONFIGURATION		
Description	Material	Part number
Piloted stainless steel pressure regulator	Stainless steel small passages	155-610-230
Piloted stainless steel pressure regulator large passage	Stainless steel large passages	155-610-050
Piloted non-stick treated pressure regulator	Non-stick	055-370-100
Piloted regulator with wall bracket and pressure gauge	Stainless steel	155-610-060



Piloted regulator manual control

■ Back pressure regulator - low pressure

Available in stainless steel manual control version.

SPECIFICATIONS	
Pressure - regulated materials	58 psi (4 bar) max
Weight	2.8 lbs. (1.3 kg)
Width	3.3 in (8.5 cm)
Height	6.6 in (16.8 cm)
Wetted parts	Stainless steel, PTFE, carbide

FITTINGS	
Fluid inlet	F 1/4" BSP
Fluid outlet	M 1/4" BSP + (M18x125, M3/8"NPS, M 3/8"BSP)

CONFIGURATION	
Back pressure regulator	155-610-100
Options:	-
- Wall bracket	016-200-010
- Pressure gauge: stainless MF 1/4 elbow	050-470-101
Stainless steel tube	050-081-701
Stainless steel coupling 1/4" F/F	050-470-301
Gauge	910-011-402



■ Low pressure gauges

Metal pressure gauge with glass and glycerin lens; totally impact and solvent resistant.

LOW PRESSURE GAUGES				
Description	Pressure range	Fitting	Internal diameter	Part number
Gauge, liquid 30 psi (2 bar), S/S	30 psi (2 bar)	1/4" NPTM		85-2810-00
Gauge, liquid 60 psi (4 bar), S/S	60 psi (4 bar)	1/4" NPTM		85-3103-00
Gauge, liquid 100 psi (6.8 bar), S/S	100 psi (6.8 bar)	1/4" NPTM		668-668-405



Filter 870 psi (60 bar)

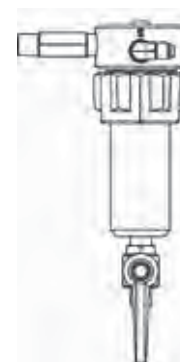

CONFIGURATION

Description	Part number
Stainless steel filter fitting length 70 mm (MM 3/8" NPT)	055-580-301
Wall-mounted bracket and screws for 3/8", 3/4" and 1" filter with 9 digits part numbers	155-190-105

EQUIPPED FILTER

Description	Maximum fluid pressure	Stainless steel screen for filter	Thread			Part number
			Inlet	Outlet	Drain	
Bare 3/8" stainless steel filter- medium pressure	870 psi (60 bar)	6	F 3/8" NPT (x1)	F 3/8" NPT (x2)	F 3/8" G tank (x1)	155-580-500
Stainless steel filter 3/8"- Low pressure	870 psi (60 bar)	6	M 1/4" NPT	M #5 JIC ⁽¹⁾	M 18x125	155-580-510

(1) See adaptation fitting F1/2 JICart mount3/8 NPS reference 050-123.533

Suction rod strainers



STRAINERS CONFIGURATION

Pump	Height	External	Material	Filtration size		Part number
				Micron	Mesh	
PMP150 / 02.75	2.3 in (60 mm)	1.5 in (40 mm)	Polyamide	300	50	051-531-600
PDM 01.75 / 04.120 / 04.120F	1.5 in (40 mm)	1.9 in (48 mm)	S/S	1000	15	149-596-152
04.220 F	4.4 in (112 mm)	2.6 in (66 mm)	Polyamide	1000	15	149-591-400

Fluid filters for screen and cartridges

SCREEN CONFIGURATION (FILTRATION SURFACE 65 CM²)

Filter number	Filtration size		Nozzle size	Part number
	Micron	Mesh		
1	40	325	3	000-161-101
2	74	200	4	000-161-102
3	90	170	4	000-161-103
4	100	140	4	000-161-104
6	168	85	6	000-161-106
8	210	70	09 & 14	000-161-108
12	280	55	20	000-161-112
15	360	45	30 & 45	000-161-115
20	510	30	< 68	000-161-020
30	750	20	< 68	000-161-030



CYCLIX™ AGITATORS FOR 5-55 GAL (20-200 L) DRUMS

This elevator-agitator for 5-55 gal (20-200 L) drums features a bi-directinal jack for a fast lift of a stainless steel cover fitted for a quick material drum change. The cover is equipped with a motorized agitator fitted with blades for low viscosity materials and a full stainless steel rod.

The elevator features a large mounting plate which makes it very stable and easy to install in paint kitchens, existing installations or an essential component of new installations.



FEATURES	BENEFITS
Stainless steel (agitator cover, suction and drain rods)	Compatibility with all materials
Adjustable suction rod height	No product loss
Suction and return tubes	Suitable for recirculating
Double effect jack with 3 position command lever: up, stop, down	Important flexibility
The agitator cannot work during elevator movements	Security

CHARACTERISTICS			
Capacity	5 gal (20 L)	55 gal (200 L)	
Motor type	Pneumatic	Pneumatic	
Reductor type	-	Gear drive	
Rotation speed (rpm)	60 - 300	5 - 90	
Motor torque	Nm	2.2	34

CYCLIX™ PART NUMBERS FOR 55 GAL (200 L) DRUMS

Description	Elevator height	Agitator rod length	Paddle diameter	Cover diameter	Part number
Elevator for 55 gal (200 L) drums	59.4 in min - 94.8 in max 1510 mm (mini) - 2410 mm (maxi)	-	-	-	62-2512-00

PART NUMBERS

Description	Part number
Agitator, 5 gallon, c/w cover, bare elevator	668-668-806
Agitator, 5 gallon, c/w flange, w/o cover, S/S blade	668-332-600
Agitator, 55 gallon, w/o cover	668-668-324
Agitator, 55 gallon, c/w elevator, cover, gear drive	668-000-551
Agitator, 55 gallon, c/w cover, elevator, bracket, direct drive	668-900-225
Agitator, 55 gallon, c/w cover, gear drive	668-000-606
Agitator, 55 gallon, S/S, cover, nylon blade	668-668-320

RECOMMENDED ACCESSORIES

Description	Part number
1/4" air lubricator + support	154-261-997
Exhaust assembly with oil recovery (length 1 m)	154-261-996
Air feeding kit	154-261-930
Drum roller unit for 55 gal (200 liter) drum	151-098-100
Slotted paddle for thick materials	154-261-952



Product hoses for airspray pressures

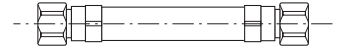

HOSE CONFIGURATION

Material		Black synthetic (RMA B ORS) with nylon 11 core	
Color		Black	
Internal diameter		1/4" (6.35 mm)	3/8" (9.5 mm)
Max pressure:		750 psi (50 bar)	
Temperature		up to 190 °F (85°C)	
Part number	Description	Part number	Description
668-362-000	Hose, fluid, 1/4, per foot	668-363-000	Hose, fluid, 3/8, per foot
668-362-100	Hose, fluid, 1/4, 750 psi, 100ft c/w 3/8 npsf	668-363-110	Hose, fluid, 3/8, 750 psi, 10ft c/w 3/8 npsf
668-362-103	Hose, fluid, 1/4, 750 psi, 3ft c/w 3/8 npsf	668-363-116	Hose, fluid, 3/8, 750 psi, 16ft c/w 3/8 npsf
668-362-105	Hose, fluid, 1/4, 750 psi, 5ft c/w 3/8 npsf	668-363-120	Hose, fluid, 3/8, 750 psi, 20ft c/w 3/8 npsf
668-362-106	Hose, fluid, 1/4, 750 psi, 6ft c/w 3/8 npsf	668-363-125	Hose, fluid, 3/8, 750 psi, 25ft c/w 3/8 npsf
668-362-110	Hose, fluid, 1/4, 750 psi, 10ft c/w 3/8 npsf	668-363-130	Hose, fluid, 3/8, 750 psi, 30ft c/w 3/8 npsf
668-362-116	Hose, fluid, 1/4, 750 psi, 16ft c/w 3/8 npsf	668-363-132	Hose, fluid, 3/8, 750 psi, 32ft c/w 3/8 npsf
668-362-120	Hose, fluid, 1/4, 750 psi, 20ft c/w 3/8 npsf	668-363-135	Hose, fluid, 3/8, 750 psi, 35ft c/w 3/8 npsf
668-362-125	Hose, fluid, 1/4, 750 psi, 25ft c/w 3/8 npsf	668-363-140	Hose, fluid, 3/8, 750 psi, 40ft c/w 3/8 npsf
668-362-130	Hose, fluid, 1/4, 750 psi, 30ft c/w 3/8 npsf	668-363-150	Hose, fluid, 3/8, 750 psi, 50ft c/w 3/8 npsf
668-362-132	Hose, fluid, 1/4, 750 psi, 32ft c/w 3/8 npsf	668-363-160	Hose, fluid, 3/8, 750 psi, 60ft c/w 3/8 npsf
668-362-135	Hose, fluid, 1/4, 750 psi, 35ft c/w 3/8 npsf		
668-362-140	Hose, fluid, 1/4, 750 psi, 40ft c/w 3/8 npsf		
668-362-150	Hose, fluid, 1/4, 750 psi, 50ft c/w 3/8 npsf		
668-362-155	Hose, fluid, 1/4, 750 psi, 55ft c/w 3/8 npsf		
668-362-175	Hose, fluid, 1/4, 750 psi, 75ft c/w 3/8 npsf		
668-362-216	Hose, fluid, 1/4, 750 psi, 16ft c/w 1/4 npsf x 3/8 npsf		
668-362-225	Hose, fluid, 1/4, 750 psi, 25ft c/w 1/4 npsf x 3/8 npsf		
668-362-232	Hose, fluid, 1/4, 750 psi, 32ft c/w 1/4 npsf x 3/8 npsf		
668-362-325	Hose, fluid, 1/4, 750 psi, 25ft c/w 1/4 npsf		

Air hoses

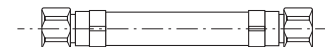

HOSE CONFIGURATION

Material	Polyurethane	Material	Nitrile
Color	Phosphor	Color	Black
Internal diameter	1/4" (6.35 mm)	Internal diameter	5/16" (8 mm)
Max pressure:	200 psi (14 bar)	Max pressure:	145 psi (10 bar)
Conductive	Yes	Conductive	Yes
Part number	Description	Part number	Description
82-2725-00	Hose, air, 1/4, (6.35mm) polyurethane,perfoot	050-389-002	Hose, air, 5/16, (8mm) 100m, 328ft
82-2725-03	Hose, air, 1/4, (6.35mm) 3ft, c/w 1/4 npsf	668-387-000	Hose, air, 5/16, (8mm) per foot
82-2725-05	Hose, air, 1/4, (6.35mm) 5ft, c/w 1/4 npsf	050-389-101	Hose, air, 5/16, (8mm) 16ft, c/w 1/4 npsf
82-2725-10	Hose, air, 1/4, (6.35mm) 10ft, c/w 1/4 npsf	050-389-102	Hose, air, 5/16, (8mm) 32ft, c/w 1/4 npsf
82-2725-16	Hose, air, 1/4, (6.35mm) 16ft, c/w 1/4 npsf	050-389-103	Hose, air, 5/16, (8mm) 25ft, c/w 1/4 npsf
82-2725-25	Hose, air, 1/4, (6.35mm) 25ft, c/w 1/4 npsf	668-395-102	Hose, air, 5/16, (8mm) 2ft, c/w 1/4 npsf
82-2725-28	Hose, air, 1/4, (6.35mm) 28ft, c/w 1/4 npsf	668-395-103	Hose, air, 5/16, (8mm) 3ft, c/w 1/4 npsf
82-2725-32	Hose, air, 1/4, (6.35mm) 32ft, c/w 1/4 npsf	668-395-105	Hose, air, 5/16, (8mm) 5ft, c/w 1/4 npsf
82-2725-35	Hose, air, 1/4, (6.35mm) 35ft, c/w 1/4 npsf	668-395-110	Hose, air, 5/16, (8mm) 10ft, c/w 1/4 npsf
82-2725-40	Hose, air, 1/4, (6.35mm) 40ft, c/w 1/4 npsf	668-395-128	Hose, air, 5/16, (8mm) 28ft, c/w 1/4 npsf
82-2725-50	Hose, air, 1/4, (6.35mm) 50ft, c/w 1/4 npsf	668-395-150	Hose, air, 5/16, (8mm) 50ft, c/w 1/4 npsf
82-2725-65	Hose, air, 1/4, (6.35mm) 65ft, c/w 1/4 npsf	668-395-160	Hose, air, 5/16, (8mm) 60ft, c/w 1/4 npsf
82-2725-75	Hose, air, 1/4, (6.35mm) 75ft, c/w 1/4 npsf	668-395-175	Hose, air, 5/16, (8mm) 75ft, c/w 1/4 npsf
82-2725-82	Hose, air, 1/4, (6.35mm) 82ft, c/w 1/4 npsf		
82-2725-100	Hose, air, 1/4, (6.35mm) 100ft, c/w 1/4 npsf		

Hose sleeve

PART NUMBERS

Part number	Description
669-990-101	Hose sleeve, 16 ft (5m)
669-990-102	Hose sleeve, 25 ft (7.5m)
669-990-103	Hose sleeve, 32 ft (10m)
669-990-104	Hose sleeve, 100 ft (30m)
669-990-105	Hose sleeve, 1000 ft (300m)
669-990-106	Hose sleeve, 50 ft (15m)
669-990-108	Hose sleeve, 65 ft (20m)

■ Lubricants and greases for pumps

LUBRICANT FOR PUMP FITTINGS

Description	Part number
Lubricants for pump fittings	
Lubricant T 8.4 oz (1/4 L) can for solvent-based paints	149-990-020
Lubricant T 1 gal	668-990-001
Lubricant T 1 qt	668-990-002
Lubricant P 1 gal	668-990-021
Lubricant P 1 qt	668-990-022
Grease	
Vaseline 2.2 lbs (1 kg) "special PMP"	560-440-002
Box of 15.8 oz (450 g) PTFE grease	560-440-001
Techni Lub tube	560-440-101
Box of grease 15.8 oz (450g)	560-420-005



■ Gun cleaning kit

PART NUMBERS

Description	Part number
Gun cleaning kit	668-000-395

1/4 in (6.4 mm) nylon brush
Gun lubricant
Tip cleaning needles
Cleaning needle pin vise
Contains all necessary items for spray gun maintenance



■ Miscellaneous

PART NUMBERS

Description	Part number
M22/Xcite™ gun wrench	049-030-042
Large size brush	906-300-101
Small size brush	906-300-102
Wrench for product filters	049-030-018
Large blow gun	129-371-000
Viscosity cup N° 4 CA4	049-221-400
Thickness gauge from 25 to 2000µ	000-790-020



NOTES

A series of horizontal dotted lines for writing notes, spanning the width of the page.

AIRMIX[®] EQUIPMENT

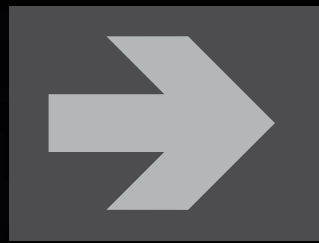

XCITE™ AIRMIX® GUN

1740-2900 psi (120-200 bar)

AIRMIX® SPRAY GUNS



The Xcite™ gun is the result of Kremlin Rexson experience since 1925. The Xcite™ gun brings excellent ergonomics to the operator. Its ultra light trigger, handle design, ergonomics and fluid swivel all reduce operator fatigue. This improves productivity and minimizes the risk of repetitive strain injuries.

The Xcite™ gun uses high quality components, which ensures a reliable gun while maintaining top notch performance. The latest generation of Airmix® atomization delivers unsurpassed finish quality.

The operator has the ability to significantly vary the fan pattern width, without changing tips. This is very useful when painting complex shaped parts.



+/- 2% according to norm (EN 13966-1)

FEATURES	BENEFITS
Ergonomic design and light trigger Product swivel fitting	Reduced fatigue and excellent working conditions for increased productivity
Product fluid passages in stainless steel	Compatible with water-based materials
Nickel brass air needle	Long service life and good reliability
Large and fine fan width adjustment	Ability to adjust the fan width to the shape of the part to be painted leads to higher efficiency and productivity
Increased atomization quality Increased transfer efficiency	Outstanding spraying quality with reduced overspray
E-Z adjust aircap	Quick, easy adjustment

SPECIFICATIONS	
Sprayed materials	Polyurethanes, water-based products, high solids, two-components products, stains, lacquers, varnishes, etc.
Body of the gun	Forged aluminum
Fluid pressure range	1740-2900-5800 psi (120-200-400 bar)
Maximum air inlet pressure	87 psi (6 bar)
Recommended atomization air pressure	11.6 - 43 psi (0.7 - 3 bar)
Fluid output	Depends on the tip used
Weight	without fluid swivel fitting: 16 oz (498 g) with fluid swivel fitting: 19.1 oz (564 g) Xcite™ 400 - 19.2 oz (587 g)
Maximum fluid temperature	122°F (50°C)
Air consumption	1.8 - 4.4 cfm (3.2 - 7.5 m³/h)
Wetted parts	Stainless steel, PTFE, carbide
Safety	Trigger lock
Filter (fitted on fluid tube)	#6 - 85 mesh/ 168µ



NOTE: for HVLV compliance, the maximum inlet air pressure at the gun handle must not exceed 2 bar (29 psi) to maintain 10 psi or less at the air cap. Testing for HVLV compliance was performed using the specified HVLV test air cap, the fan control fully open and a pressure gauge on the Air inlet fitting at the gun base or handle. It may also be a requirement of some regulatory agencies that users have the appropriate test air cap available on site to verify that the gun is being operated within the regulatory limitations.



FITTINGS		
Fitting	Air inlet	M 1/4 NPS
Swivel fitting	Fluid inlet	M #5 JIC



CONFIGURATION OF THE XCITE™ SPRAY GUN WITH AIRCAP AND FLUID SWIVEL FITTING

Gun type	Aircap	Tip	Maximum fluid pressure	Seat	Part number
Xcite™ 120	VX 24 KHVLP	See table page 96	1740 psi (120 bar)	Stainless steel	135-720-100
Xcite™ 200	VX 24 KHVLP		2900 psi (200 bar)	Carbide	135-720-200
Xcite™ 400	VX 24 KHVLP		5800 psi (400 bar)	Carbide	135-720-400



CONFIGURATION OF THE XCITE™ SPRAY GUN WITH AIRCAP WITHOUT FLUID SWIVEL FITTING

Gun type	Aircap	Tip	Maximum fluid pressure	Seat	Part number
Xcite™ 120	VX 24 KHVLP	See table page 96	1740 psi (120 bar)	Stainless steel	135-720-120
Xcite™ 200	VX 24 KHVLP		2900 psi (200 bar)	Carbide	135-720-220

XCITE™ AIRMIX® GUN

1740-2900 psi (120-200 bar)

CONFIGURATION OF THE XCITE™ SPRAY GUN WITH AIRCAP

Description	Part number
Xcite™ 120, c/w aircap, tip, swivel fitting	668-720-100
Xcite™ 200, c/w aircap, tip, swivel fitting	668-720-200
Xcite™ 200, c/w aircap, tip, w/o swivel fitting	668-720-300
Xcite™ 200, c/w aircap, tip 1/4" NPSM filter bowl	668-720-302
Xcite™ 120, c/w aircap, tip, w/o swivel fitting	668-720-400
Xcite™ 120, c/w aircap, tip, w/o swivel fitting, c/w 09-112	668-720-401
Xcite™ 120, c/w aircap, tip 1/4" npsm filter bowl 1/4" NPSM filter bowl	668-720-402
Xcite™ 120, c/w aircap, tip, w/o swivel fitting (12-114) 1/4" NPSM filter bowl	668-720-900
Xcite™ 120, c/w aircap, tip, w/o swivel fitting (12-112) 1/4" NPSM filter bowl	668-720-901

XCITE™ KITS WITH AIR AND FLUID HOSES (WITHOUT FLUID SWIVEL)



Description	Aircap Type	Tip	Diameter		Hose length	Kit part number
			Fluid hose	Conductive air hose		
Xcite™ 120	VX 24 K HVLP	See table page 96	0.19 in (4.8 mm)	0.28 in (7 mm)	25' (7.5 m)	668-720-425
Xcite™ 120	VX 24 K HVLP		0.19 in (4.8 mm)	0.28 in (7 mm)	50' (15 m)	668-720-450

XCITE™ KITS WITH SWIVEL, AIR AND FLUID HOSES



Description	Aircap Type	Tip	Diameter		Hose length	Kit part number
			Fluid hose	Conductive air hose		
Xcite™ 120	VX 24 K HVLP	See table page 96	0.19 in (4.8 mm)	0.28 in (7 mm)	25' (7.5 m)	668-720-125
Xcite™ 120	VX 24 K HVLP		0.19 in (4.8 mm)	0.28 in (7 mm)	50' (15 m)	668-720-150
Xcite™ 200	VX 24 K HVLP		0.19 in (4.8 mm)	0.28 in (7 mm)	25' (7.5 m)	668-720-225
Xcite™ 200	VX 24 K HVLP		0.19 in (4.8 mm)	0.28 in (7 mm)	50' (15 m)	668-720-250

LACQUERS, STAINS, VARNISHES

SPRAY GUN XCITE™ 120 & 200

MAINTENANCE - XCITE™ 120 & 200

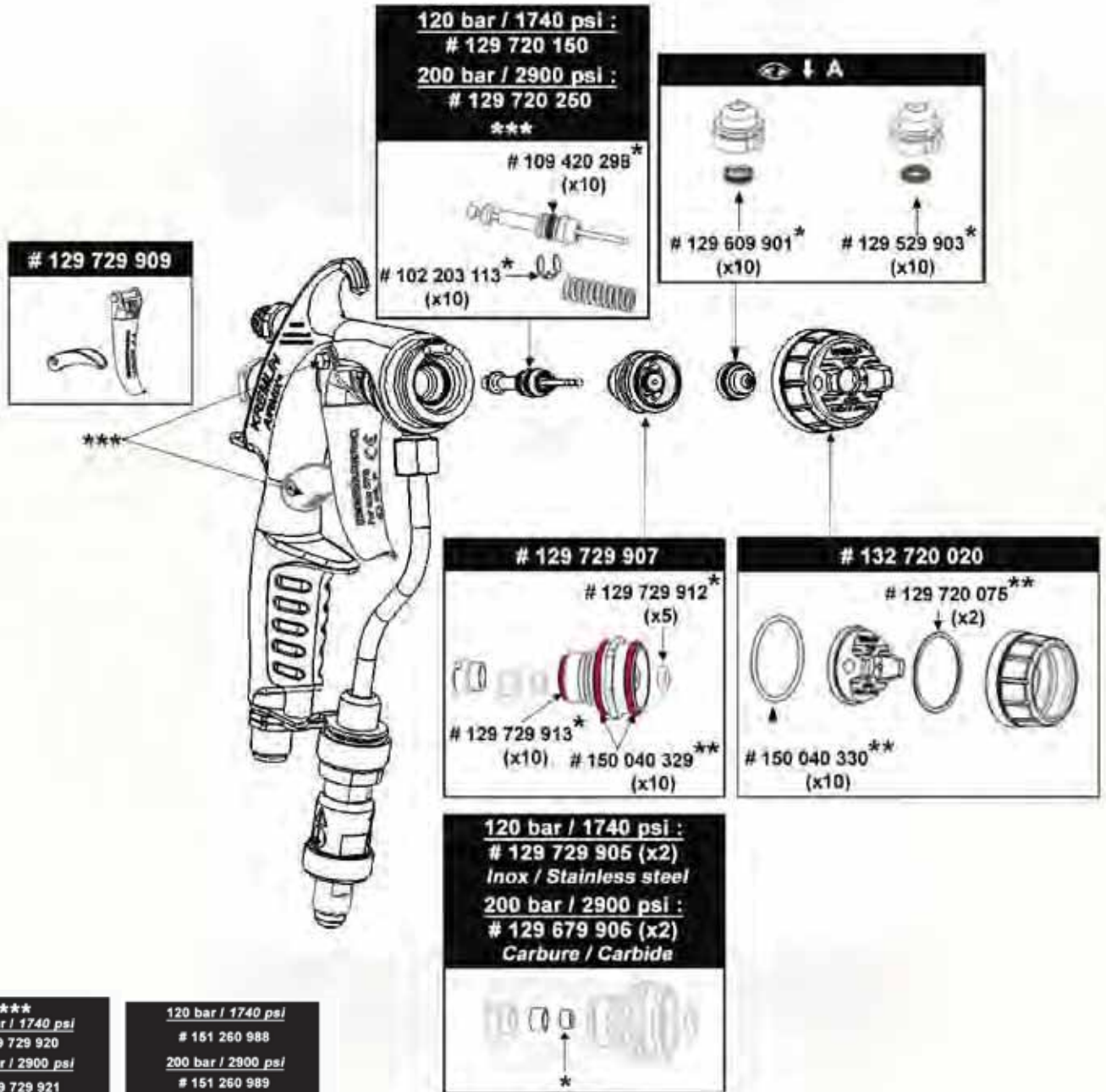

120 bar / 1740 psi
129 729 920

200 bar / 2900 psi
129 729 921

Produit / Paint

Air

120 bar / 1740 psi
151 260 988

200 bar / 2900 psi
151 260 989
Ø 4,8 mm - 7,5 mm

Air

Produit / Paint

*

129 729 904 (x10)
Acétale / Polyacetal

075 810 010
Longueur / Length : 400 mm

049 030 042

906 300 101

⊙ < 09 # 000 094 000
⊙ ≥ 09 # 000 094 002

*
129 729 901
Produit / Paint

**
129 729 908
Air

LACQUERS, STAINS, VARNISHES

SPRAY GUN XCITE™ 120 & 200

MAINTENANCE - XCITE™ 120 & 200

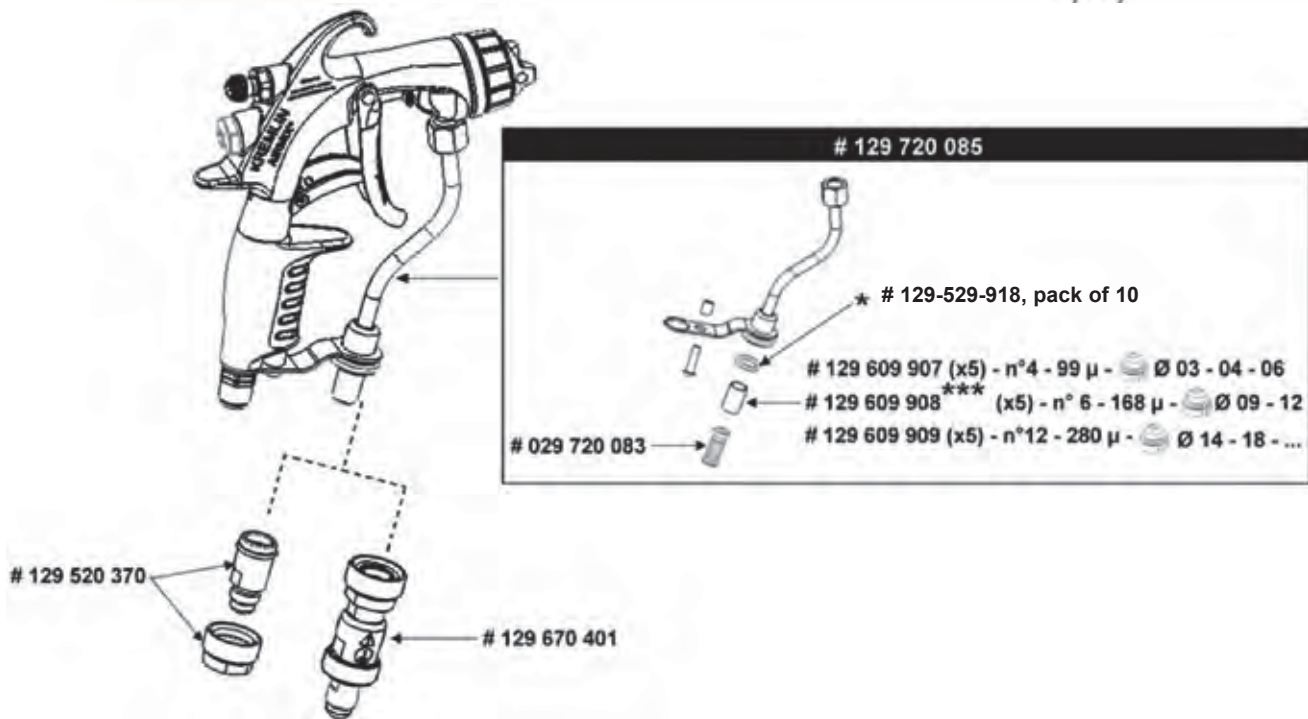
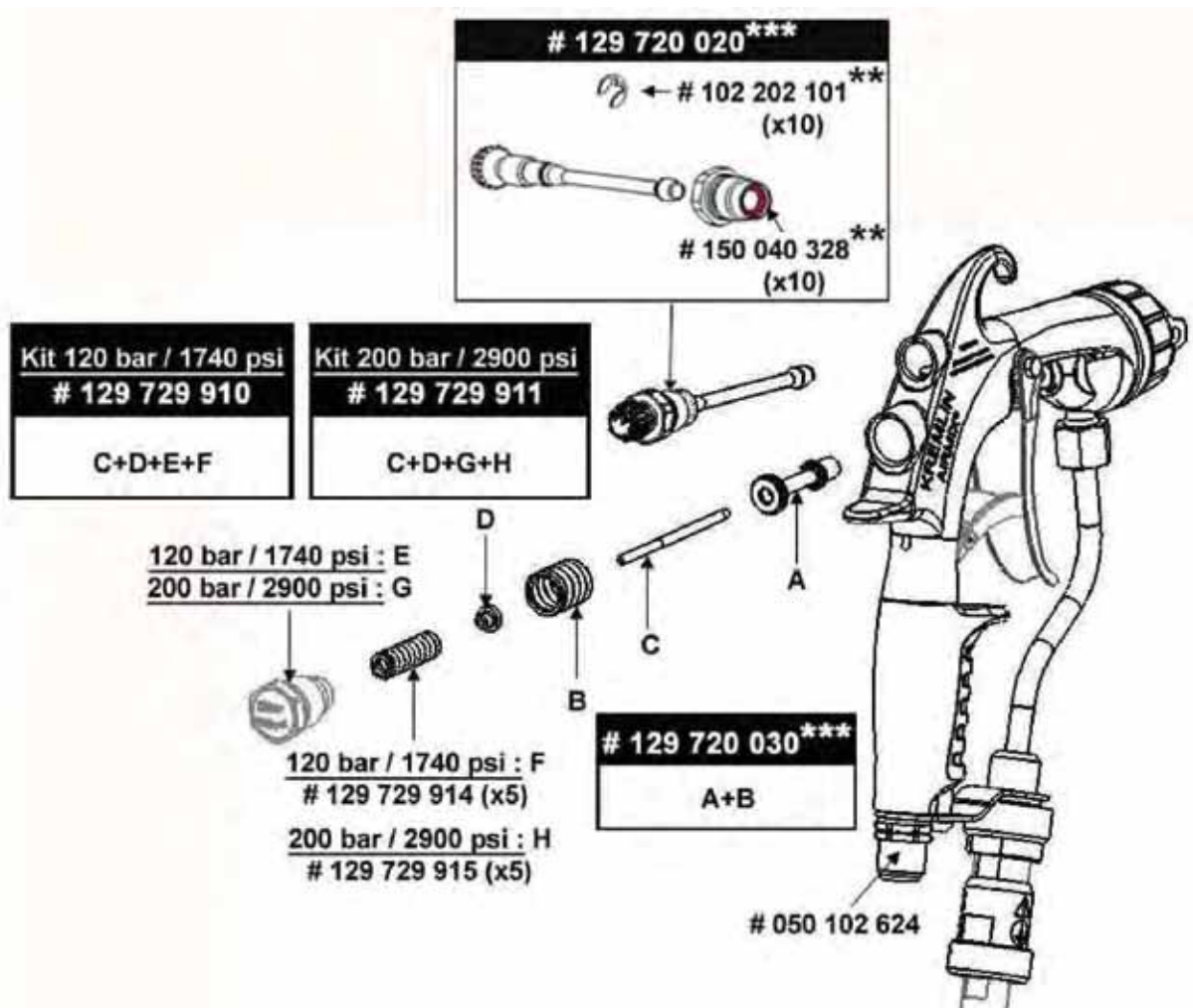



XCITE™ AIRMIX® GUN

5800 psi (400 bar)

The Xcite™ gun is the result of Kremlin Rexson experience since 1925. The Xcite™ gun brings excellent ergonomics to the operator. Its ultra light trigger, handle design, ergonomics and fluid swivel all reduce operator fatigue. This improves productivity and minimizes the risk of repetitive strain injuries.

The new Xcite™ 400 gun uses high quality components which ensure a perfect reliability maintaining a high level of performances. The Xcite™ 400 is dedicated to apply single component adhesives and sealants, MS polymers, water-based adhesives, greases, waxes and a large range of thick materials requiring an atomization pressure higher than 200 bar.

The Xcite™ gun uses high quality components, which ensures a reliable gun while maintaining top notch performance. The latest generation of Airmix® atomization delivers unsurpassed finish quality.

The operator has the ability to significantly vary the fan pattern width, without changing tips. This is very useful when painting complex shaped parts.



FEATURES	BENEFITS
Ergonomic design and light trigger Product swivel fitting	Reduced fatigue and excellent working conditions for increased productivity
Product fluid passages in stainless steel	Compatible with water-based materials
Nickel brass air needle	Long service life and good reliability
Large and fine fan width adjustment	Ability to adjust the fan width to the shape of the part to be painted leads to higher efficiency and productivity
Increased atomization quality Increased transfer efficiency	Outstanding spraying quality with reduced overspray
E-Z adjust aircap	Quick, easy adjustment

SPECIFICATIONS	
Sprayed materials	Single component adhesives and sealants, MS polymers, water-based adhesives, greases, waxes and a large range of thick materials, etc...
Body of the gun	Forged aluminum
Fluid pressure range	2900-5800 psi (200-400 bar)
Maximum air inlet pressure	87 psi (6 bar)
Recommended atomization air pressure	11.6 - 43 psi (0.7 - 3 bar)
Fluid output	Depends on the tip used
Weight	without fluid swivel fitting: 20.7 oz (587 g) with fluid swivel fitting: 19.1 oz (564 g) Xcite™ 400 - 19.2 oz (587 g)
Maximum fluid temperature	122°F (50°C)
Air consumption	1.8 - 4.4 cfm (3.2 - 7.5 m³/h)
Wetted parts	Stainless steel, PTFE, carbide
Safety	Trigger lock
Filter (fitted on fluid tube)	#6 - 85 mesh/ 168µ

FITTINGS		
Fitting	Air inlet	M 1/4 NPS
Swivel fitting	Fluid inlet	M #5 JIC



XCITE™ AIRMIX® GUN

5800 psi (400 bar)

VX 24 KHVLP
AIRCAP



CONFIGURATION OF THE XCITE™ SPRAY GUN WITH AIRCAP AND FLUID SWIVEL FITTING

Gun type	Aircap	Tip	Maximum fluid pressure	Seat	Part number
Xcite™ 400	VX 24 KHVLP		5800 psi (400 bar)	Carbide	135-720-400

■ Aircaps for AIRMIX® 400 spray gun 5800 psi (400 bar)

AIRCAP FOR XCITE™ 400 SPRAY GUN

	VX24 KHVLP
	
For Xcite™ spray guns	132-720-420
Adjustable fan	●
Spraying quality	Excellent
Transfer efficiency	Excellent
Non-stick coating	-

SEAL KITS

Description	Part number
Seal kit for Xcite™ 120 - 200 - 400 gun (air)	129-729-908
Seal kit for Xcite™ 400 gun (fluid)	129-729-941
Repair kit for Xcite™ 400 gun (seal kits included)	129-729-943

OLD GENERATION SEAL KITS

Description	Part number
Seal kit for MVX spray gun	129-679-901
Repair kit for MVX spray gun (seal kit included)	129-679-902

LACQUERS, STAINS, VARNISHES

SPRAY GUN XCITE™ 400

MAINTENANCE - XCITE™ 400

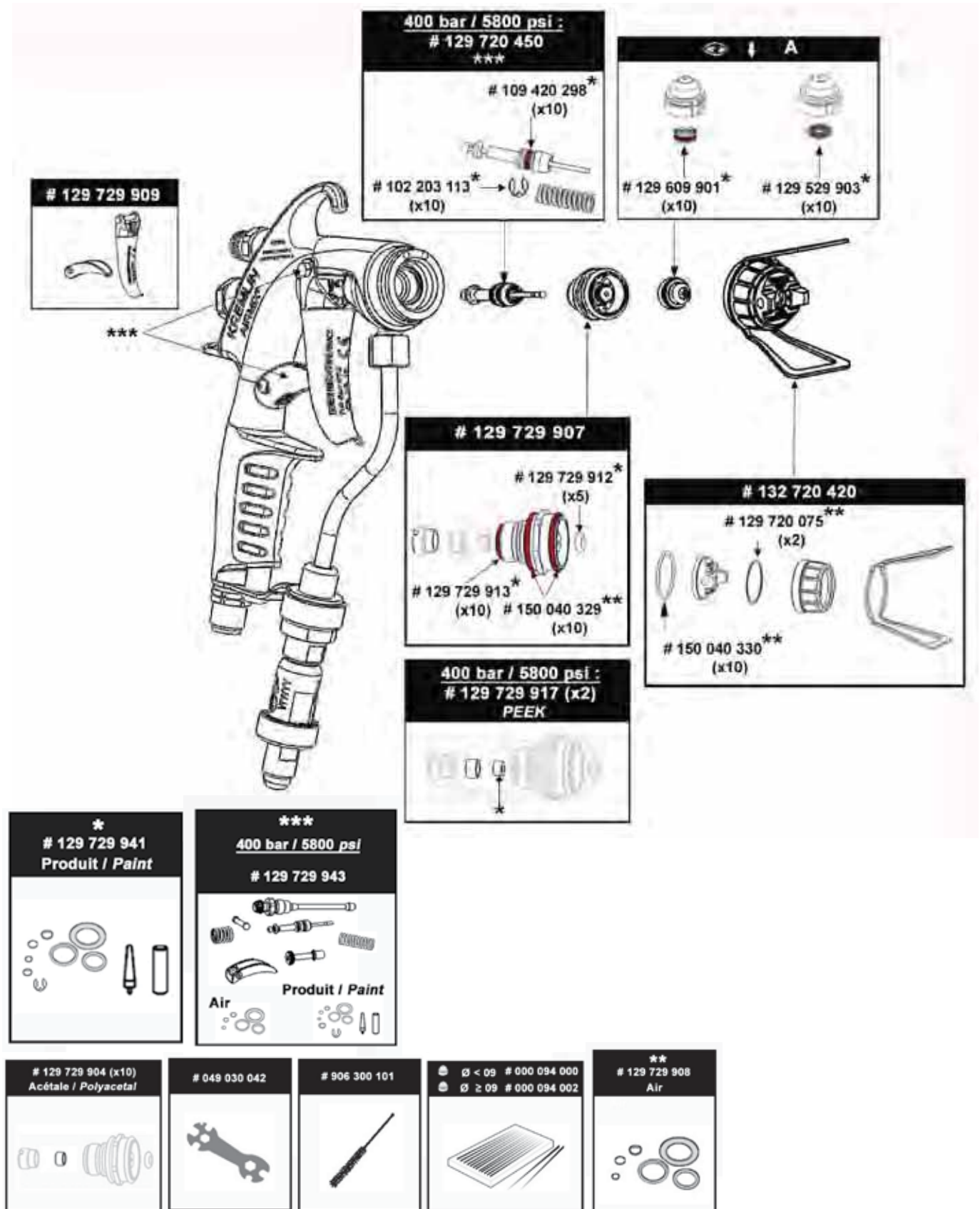

LACQUERS, STAINS, VARNISHES

SPRAY GUN XCITE™ 400

MAINTENANCE - XCITE™ 400

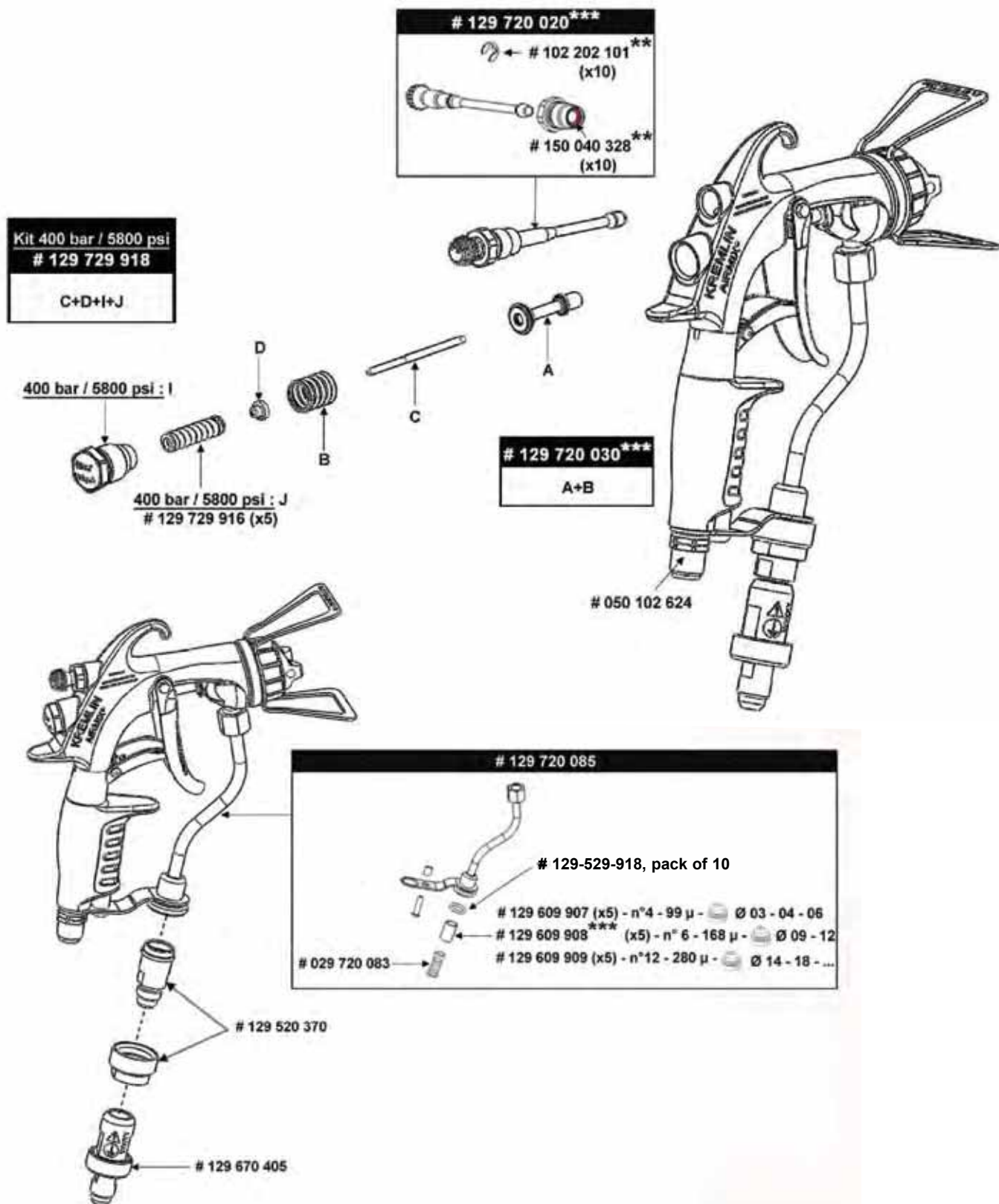

AIRMIX® TIPS

The choice of the tip is based on the desired flow rate in order to achieve a good finish and reduce paint costs. An AIRMIX® tip needs to be replaced frequently in order to maintain the original transfer efficiency.

To order a tip, replace the "x" characters in the table, by the chosen tip number in 134-5xx.xx4 for a Fine Finish or 134-5xx.xx2 for an Xtra™ Fine Finish tip, recommended for water-based materials or for an increased atomization quality due to the preatomization.



(For example: order 134-509-094 (Fine Finish) or 134-509-092 (Xtra™ Fine Finish) if choosing a 09.09 tip).

Tip Number	Fluid Output				Diameter in Inches	Diameter in mm	Gun Filter		Pump Filter		Spray Angle and Max fan width at gun target distance of 10" from Substrate										
	500 psi 35 bar		1000 psi 70 bar				Mesh	Filter #	Mesh	Filter #	10°	18°	30°	40°	45°	50°	60°	67°	75°	82°	90°
	oz/min	cm³/min	oz/min	cm³/min							3.5"	5"	7"	9"	9.5"	10"	12"	13"	15"	18"	22"
	9 cm	13 cm	18 cm	23 cm			24 cm	25 cm	31 cm	33 cm	38 cm	46 cm	60 cm								
02	1.2	40	3.4	100	0.005	0.127	140 (4)	200 (2)	02-03	02-05											
03	3.4	100	5.1	150	0.007	0.178			03-03	03-05	03-07										
04	5.1	150	6.8	200	0.009	0.229			04-03	04-05	04-07	04-09	04-10	04-11	04-13						
06	6.8	200	11.2	330	0.011	0.279			06-03	06-05	06-07	06-09	06-10	06-11	06-13	06-15					
09	10.1	300	15.2	450	0.013	0.330	85 (6)	85 (6)	09-03	09-05	09-07	09-09	09-10	09-11	09-13	09-15					
12	11.2	350	20.3	600	0.015	0.381		70 (8)		12-05	12-07	12-09	12-10	12-11	12-13	12-15	12-17				
14	13.5	400	24.4	720	0.016	0.406	60 (12)	60 (12)	14-03	14-05	14-07	14-09	14-10	14-11	14-13	14-15	14-17				
18	15.2	450	28.7	850	0.018	0.457				18-05	18-07	18-09	18-10	18-11	18-13	18-15	18-17				
20	16.9	500	35.8	1,060	0.020	0.508					20-07	20-09	20-10	20-11	20-13	20-15	20-17	20-19			
25	22.0	650	45.0	1,330	0.022	0.559					25-07	25-09	25-10	25-11	25-13	25-15	25-17				
30	25.4	750	54.1	1,600	0.024	0.610					30-07	30-09	30-10	30-11	30-13	30-15	30-17	30-19			
40	33.3	985	66.6	1,970	0.027	0.686						40-09	40-10	40-11	40-13	40-15	40-17	40-19	40-21		
45	38.9	1150	77.8	2,300	0.029	0.737							45-10	45-11	45-13	45-15	45-17	45-19	45-21		
60	43.3	1281	86.6	2,561	0.031	0.787							60-10	60-11	60-13	60-15	60-17	60-19	60-21		

Standard tips
 - To order a tip, replace the crosses in 134-5xx-xx4 with the corresponding number from the chart above.

(Example: 134-506-094 for a 06-09 tip)

Xtra™ tips
 To order a tip, replace the crosses in 134-5xx-xx2 with the corresponding number from the chart above.

(Example: 134-506-092 for a 06-09 tip)
 Ideally used for waterborne materials.

Special Order tips - These tips require a minimum of 25 tips per order and these tips cannot be ordered in the Xtra™ tip style.

Optimum Fan Adjustment
 - These tips allow for fan adjustment when used with a VX24 air cap.

■ Microscreens and tip seals

PART NUMBERS		
Tip size	Microscreen (99 µ) (pack of 10)	PTFE O'ring seals (pack of 10)
02-03-04-06	129-609-901	-
09 and above	-	129-529-903

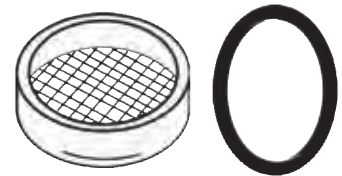

■ Tip cleaning needles

PART NUMBERS			
Description	Nozzles Size	Quantity	Part number
Unclogging needles	≤ 0.035 in (0.9 mm)	12	000-094-000
Unplugging needles	≥ 0.035 in (0.9 mm)	12	000-094-002

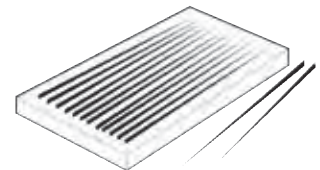

■ Unclogging needle holder

PART NUMBER	
Type	Part number
Unclogging needle holder	669-094-000



■ Seats for spray guns

SEATS FOR XCITE™ SPRAY GUNS		
Type	Quantity	Part number
Polyacetal	10	129-729-904
Stainless steel with seal	2	129-729-905
Carbide with seal	2	129-679-906

SEATS FOR MVX SPRAY GUNS		
Type	Quantity	Part number
Polyacetal	10	129-679-904
Stainless steel with seal	2	129-679-905
Carbide with seal	2	129-679-906

SEAL KIT FOR AIRMIX® GUNS		
Description	Quantity	Part number
Seals for stainless steel or carbide seats	10	129-629-922



■ Gun fluid filter screen

PART NUMBERS			
Stainless steel screen for filter	Size (µ)	Quantity	Part number
N° 4	100	5	129-609-907
N° 6	168	5	129-609-908
N° 12	280	5	129-609-909

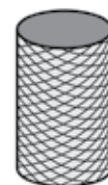

■ Atomizing air needle valve

For air adjustment at the gun inlet

ADJUSTING NEEDLE VALVES	
Description	Part number
Adjusting needle for Xcite™, MVX, MXLT (MF 1/4") spray guns	050-070-190



■ Extensions for Airmix® spray guns

AIRMIX® spray guns can be fitted with extensions in order to spray inaccessible areas.

EXTENSIONS FOR XCITE™ SPRAY GUNS

Description	Length	Part number
Straight extension	15.7 in (400 mm)	075-810-010



EXTENSIONS FOR MVX SPRAY GUNS

Description	Length	Part number
Straight extension	15.7 in (400 mm)	668-668-663
Elbow extension (45° angle)	9.8 in (250 mm)	668-668-896

■ Y-fitting for one additional gun supply

Fluid circuit: remove the plug of the second fluid filter outlet and connect the elbow fitting.
Air circuit: add the Y-fitting to the outlet of the air regulator on the pump.

TWO-GUN SYSTEM

Description	Material	Part number
Fluid Y-fitting #5 JIC	Stainless steel	029-520-500



■ Two gun manifold (stainless steel)

For supplying two guns with air and solvent-based paint including shut-off valves

TWO-GUN SYSTEM

Description	Part number
Two guns manifold for Airmix® guns	669-669-017



■ Gun cleaning kit

PART NUMBERS

Description	Part number
Gun cleaning kit	668-000-395

1/4 in (6.4 mm) nylon brush
Gun lubricant
Tip cleaning needles
Cleaning needle pin vise
Contains all necessary items for spray gun maintenance





AVX AIRMIX®

Airmix technology – Modular design for high volume production

The AVX gun is a smaller, lighter Automatic gun for spray machines. The latest generation of Airmix atomization delivers unsurpassed finish quality and high transfer efficiency. The AVX gun is offered in two types of fluid circulation. First is through the base for minimal pressure loss. Second is through the base and gun to minimize dead areas and improve flushing.



+/- 2% according to norm (EN 13966-1)

FEATURES	BENEFITS
Light AIRMIX® technology: Reduced size and weight	Optimal application performances
Excellent atomization quality with outstanding transfer efficiency	Excellent finish quality, reduced paint costs, cleaner working environment, lower booth maintenance
Stainless steel construction	Compatible with water-based materials
Choice of circulation in the base or the gun	Performance level guaranteed for most materials and easy flushing
Choice of bases with rear or side connections	To fit each customer need
Choice of tips for water-based materials	The design of the gun optimizes performances and even flow. Dedicated tips (Xtra™ Fine Finish) optimizes application performances
Adjusting fan width kit as an option	To benefit from large possibilities of fan or flow rate adjustment



SPECIFICATIONS	
Maximum air inlet pressure	87 psi (6 bar)
Maximum fluid pressure	2900 psi (200 bar)
Trigger air pressure	43 psi (3 bar) mini
Recommended atomization air pressure	10 - 43 psi (0.7 - 3 bar)
Fluid output	See table page 104
Weight (gun only)	15.9 oz (452 g)
Maximum fluid temperature	122°F (50°C)
Air consumption	1.7 - 4.4 cfm (3 - 7.5 m³/h)
Wetted parts	Stainless steel - treated stainless steel
Seat	Comes in stainless steel, carbide or polyacetal as an option



NOTE: for HVLP compliance, the maximum inlet air pressure at the gun base must not exceed 14.35 psi (0.99 bar) to maintain 10 psi or less at the air cap. Testing for HVLP compliance was performed using the specified HVLP test air cap, the fan control fully closed and a pressure gauge on the Air inlet fitting at the gun base or handle. It may also be a requirement of some regulatory agencies that users have the appropriate test air cap available on site to verify that the gun is being operated within the regulatory limitations.

FITTINGS		
Power supply	Gun base	Fittings supplied, non fitted
Fluid	F 1/4" NPS	#5 JIC - blue Airmix® hose, Ø 4.8 or 6,35 mm
Atomization air	F 1/4" NPS	M 1/4" NPS - air hose Ø 7 int
Pilot air	F 1/8" NPS	Quick fittings - polyamide hose Ø 4x6

CONFIGURATION OF THE AVX GUN FITTED WITHOUT BASE				
Description	Version	Aircap	Nozzle	Part number
AVX gun (⊥)	circulation in the base	See table page 104	See table page 96	129-690-000
AVX gun (Ω)	circulation in the gun	See table page 104	See table page 96	129-691-000

CONFIGURATION OF THE AVX GUN FITTED WITH BASE					
Description	Base type	Version	Aircap	Nozzle	Part number
AVX gun (⊥)	side outputs	circulation in the base	See table page 104	See table page 96	129-695-000
AVX gun (Ω)	side outputs	circulation in the gun			129-695-100
AVX gun (⊥)	rear outputs	circulation in the base			129-695-050
AVX gun (Ω)	rear outputs	circulation in the gun			129-695-150

KITS	
Description	Part number
AVX seal kit (air and fluid)	129-690-901

AVX AIRMIX®

PART NUMBERS

Description	Part number
AVX, c/w cap & tip, no base	668-690-000
AVX, base circulation, c/w side inlet, aircap, tip	668-695-000
AVX, base circulation, c/w rear inlet, aircap, tip	668-695-050
AVX, gun circulation, c/w side inlet, aircap, tip	668-695-100
AVX, gun circulation, c/w rear inlet, aircap,tip	668-695-150
AVX, c/w Cefla base, aircap tip, fitting kit	668-695-200
AVX, standard side inlet, c/w aircap, tip (Cefla)	668-695-201
AVX, standard rear inlet, c/w aircap, tip (Cefla)	668-695-202
AVX, base circ, c/w rear inlet,aircap, tip, remote fan	668-695-700
AVX, base circ, c/w rear inlet,aircap, tip, remote fan	668-695-701
AVX, base circ, side inlet, c/w aircap, tip (Superfici)	668-695-800
AVX, base circ, side inlet, c/w aircap, 09-154, bsp (Makor)	668-695-850

BASES FOR THE AVX GUN

Description	Base type	Weight	Wetted parts	Part number
Base for AVX (circulation in the base (L))	side outlet	8.4 oz (240 g)	stainless steel	129-690-070
Base for AVX (circulation in the gun (Ω))				129-691-070
Base for AVX (circulation in the base (L))	rear outlet	16.9 oz (480 g)	stainless steel	129-690-080
Base for AVX (circulation in the gun (Ω))				129-691-080

FITTING KITS

Description	Part number
Fitting kit for side outlet base	129-690-075
Fitting kit for rear outlet base	129-690-085

SUPPORTS

Description	Part number
Mounting support 5/8" Ø16	049-351-000
Mounting support 1/2" Ø12	049-351-700
Adjustable mounting support for 1/2" Ø12 support	049-351-705

KIT

Description	Part number
Remote adjusting fan width kit	029-253-002

ATX AIRMIX®

AUTOMATIC AIRMIX® GUNS



The ATX Airmix® gun, with its unsurpassed quality of atomization provides high finish quality and important product savings. Recognized worldwide, ATX automatic guns are widely used in automatic finishing lines in most markets. The fluid circulation is available in the base (no pressure loss) or inside the gun (quick flushing).

FEATURES	BENEFITS
Excellent atomization quality with outstanding transfer efficiency	Excellent finish quality, reduced paint costs, cleaner working environment, lower booth maintenance
Modular design	Quick service: only 4 bolts to unscrew, no need to remove hoses
Stainless steel construction	Compatible with water-based materials

SPECIFICATIONS	
Maximum air inlet pressure	87 psi (6 bar)
Maximum fluid pressure	2900 psi (200 bar)
Trigger air pressure	43 psi (3 bar) mini
Recommended atomization air pressure	14.5 - 43.5 psi (1 - 3 bar)
Fluid output	See table page 104
Weight (gun only)	26.5 oz (750 g)
Maximum fluid temperature	122°F (50°C)
Air consumption	1.7 - 4.4 cfm (3 - 7.5 m³/h)
Wetted parts	Stainless steel - treated stainless steel
Seat	Stainless steel, Carbide, Polyacetal as an option

FITTINGS		
Power supply	Gun base	Fittings supplied, non fitted
Fluid	F 1/4" NPS	Elbow M 1/4" NPT - #5 JIC
Atomization air	F 1/4" NPS	M 1/8" BSP - 4x6 hose
Pilot air	F 1/8" NPS	M 1/4" BSP - M 1/4" NPS



NOTE: for HVLP compliance, the maximum inlet air pressure at the gun base must not exceed 14.35 psi (0.99 bar) to maintain 10 psi or less at the air cap. Testing for HVLP compliance was performed using the specified HVLP test air cap, the fan control fully closed and a pressure gauge on the Air inlet fitting at the gun base or handle. It may also be a requirement of some regulatory agencies that users have the appropriate test air cap available on site to verify that the gun is being operated within the regulatory limitations.

CONFIGURATION OF THE ATX GUN FITTED WITHOUT BASE

Description	Version	Aircap	Nozzle	Part number
ATX gun (⊥)	circulation in the base	See table page 104	See table page 96	129-625-000
ATX gun (Ω)	circulation in the gun	See table page 104	See table page 96	129-626-505

BASE FOR ATX GUN

Description	Base type	Weight	Wetted parts	Part number
ATX base (circulation in the base (⊥))	side outlet	10.9 oz (310 g)	stainless steel	129-260-315
ATX base (circulation in the gun (Ω))		129-626-510		

PART NUMBERS

Description	Part number
ATX, c/w base, aircap, tip	668-625-001
ATX, Cattinair, c/w base, aircap, tip, 2 x #5 JIC swivels	668-625-002
ATX, c/w cap & tip, no base	668-625-003
ATX, c/w Cefla base, aircap, tip, fitting kit	668-625-005
ATX UV, c/w base, aircap, tip	668-625-700
ATX UV, Cattinair, c/w base, aircap, tip, 2 x #5 JIC swivels	668-625-701
ATX UV, c/w Cefla base aircap, tip, fitting kit	668-625-705
ATX UV, c/w Cefla base aircap, tip, w/o fitting	668-625-710
ATX, drum, c/w base, aircap, tip	668-626-505

KITS

Description	Part number
ATX seal kit (air and fluid)	129-251-995
Support and screen n°2 kit	129-629-906
Support and screen n°4 kit	129-629-905
Support and screen n°6 kit	129-629-907
Support and screen n°12 kit	129-629-916

SUPPORTS

Description	Part number
Mounting support 5/8" Ø16	049-351-000
Mounting support 1/2" Ø12	049-351-700
Adjustable mounting support for Ø12 support	049-351-705

KIT

Description	Part number
Remote adjusting fan width kit	029-253-002



AXC AIRMIX®

Compact AIRMIX® technology - reduced size. The AXC Airmix® gun, thanks to its ultra-compact size and very reduced weight increases the performances and the efficiency of the automatic machines. Large dimension fluid passages to handle a wide range of materials. The atomization quality offered by latest generation aircaps and tips guarantees fine finish quality and very important product savings.

FEATURES	BENEFITS
Compact Airmix® technology - reduced size and weight	Optimal application performances
Excellent atomization quality with outstanding transfer efficiency	Excellent finish quality, reduced paint costs, cleaner working environment, lower booth maintenance
Stainless steel construction	Compatible with water-based materials
Choice of tips for water-based materials	The design of the gun optimizes performances and even flow. Dedicated tips (Xtra™ Fine Finish) optimizes application performances
Adjusting fan width kit as an option	To benefit from large possibilities of fan or flow rate adjustment



SPECIFICATIONS	
Maximum air inlet pressure	87 psi (6 bar)
Maximum fluid pressure	2900 psi (200 bar)
Trigger air pressure	43 psi (3 bar) mini
Recommended atomization air pressure	14.5 - 43.5 psi (1 - 3 bar)
Fluid output	See table page 104
Weight (gun only)	16.6 oz (472 g)
Maximum fluid temperature	122°F (50°C)
Air consumption	1.7 - 4.4 cfm (3 - 7.5 m³/h)
Wetted parts	Stainless steel - treated stainless steel
Seat	Comes in stainless steel, carbide or polyacetal as an option

NOTE: for HVLP compliance, the maximum inlet air pressure at the gun base must not exceed 14.35 psi (0.99 bar) to maintain 10 psi or less at the air cap. Testing for HVLP compliance was performed using the specified HVLP test air cap, the fan control fully closed and a pressure gauge on the Air inlet fitting at the gun base or handle. It may also be a requirement of some regulatory agencies that users have the appropriate test air cap available on site to verify that the gun is being operated within the regulatory limitations.

FITTINGS	
Power supply	Fittings supplied, non fitted
Fluid	#5 JIC - blue Airmix® hose, Ø 4.8 or 6.35 mm
Atomization air	Quick fittings - polyamide hose Ø 6x8
Pilot air	Quick fittings - polyamide hose Ø 4x6



CONFIGURATION OF THE AXC GUN			
Description	Aircap	Tip	Part number
AXC gun w/o tip, aircap	See table page 104	See table page 104	129-697-000
AXC gun c/w tip, aircap	VX114	See table page 104	668-697-000

KITS	
Description	Part number
AXC seal kit (air and fluid)	129-697-901
Air inlet fitting kit	129-697-902
Remote adjusting fan kit	129-697-250
Stainless steel Y-fitting - for AIRMIX® guns	029-520-500

SUPPORTS	
Description	Part number
Mounting support 5/8" Ø16	049-351-000

■ Aircaps for AIRMIX® AVX, AXC and ATX

AIRCAPS FOR AVX & AXC SPRAY GUNS

	VX124	VX24	VX54
			
For AVX/AXC spray guns	132-720-055	132-720-020 ⁽¹⁾	132-670-030
Adjustable fan	-	●	-
Spraying quality	Excellent	Excellent	Good
Transfer efficiency	Excellent	Excellent	Very good
Non-stick coating	●	●	●

AIRCAPS FOR ATX SPRAY GUNS

	BX116	BX16	BX 56
			
ATX gun	132-650-550	132-650-450 ⁽¹⁾	132-650-300
Adjustable fan	-	●	-
Spraying quality	Excellent	Excellent	Good
Transfer efficiency	Good	Good	Very good
Non-stick coating	-	-	●

(1) to be used with the remote width adjustment kit

NOTES

Notes section containing 25 horizontal dotted lines for writing.



ESS

E

■ Microscreens and tip seals

PART NUMBERS

Tip size	Microscreen (99 µ) (pack of 10)	PTFE O'ring seals (pack of 10)
02-03-04-06	129-609-901	-
09 and above	-	129-529-903

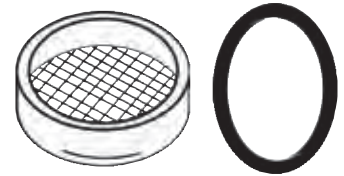

■ Tip cleaning needles

PART NUMBERS

Description	Nozzles Size (mm)	Quantity	Part number
Unclogging needles	≤ 0.035 in (0.9 mm)	12	000-094-000
Unclogging needles	≥ 0.035 in (0.9 mm)	12	000-094-002

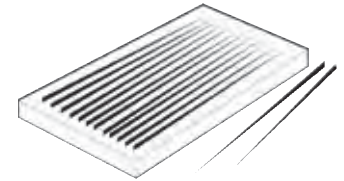

■ Unclogging needle holder

PART NUMBER

Type	Part number
Unclogging needle holder	669-094-000



■ Seats for automatic spray guns

SEATS FOR AVX AND AXC

Type	Quantity	Part number
Polyacetal	10	129-679-904
Stainless steel with seal	2	129-679-905
Carbide with seal	2	129-679-906

SEATS FOR ATX SPRAY GUNS

Type	Quantity	Part number
Polyacetal	10	129-609-911
Stainless steel with seal	2	129-629-923
Carbide with seal	2	129-659-904

SEALS FOR AIRMIX® GUN SEATS

Description	Quantity	Part number
Seals for stainless steel or carbide seats	10	129-629-922



■ In-line paint filter

With its compact dimensions, it fits on base of the handle or between two hoses

FILTERS

Description	Set-up	Maximum fluid pressure	Thread		Part number
			Inlet	Outlet	
Stainless steel filters supplied with 6 screen - 168µ	Between 2 hoses	2900 psi (200 bar)	M1/2 JIC	M1/2 JIC	155-010-000
	At the gun Fluid inlet		M1/2 JIC	F1/2 JIC	155-010-100

■ Gun fluid filter screen



PART NUMBERS			
Stainless steel screen for filter	Size (μ)	Quantity	Part number
N° 4	100	5	129-609-907
N° 6	168	5	129-609-908
N° 12	280	5	129-609-909

■ Extension for AVX and AXC spray guns

EXTENSIONS		
Description	Length	Part number
Straight extension	15.7 in (40 cm)	668-668-663
Elbow extension (45° angle)	9.8 in (25 cm)	668-668-896

■ Gun cleaning kit

PART NUMBERS	
Description	Part number
1/4 in (6.4 mm) nylon brush Gun lubricant Tip cleaning needles Cleaning needle pin vise Contains all necessary items for spray gun maintenance	668-000-395



EOS 10-C18 PUMP & XCITE™



The EOS 10-C18 complete Plug & Spray outfit comprises of the pump available in wall-mounted or tripod configuration, the Airmix® Xcite™ 120 bar gun fitted with a 06.094 tip and 7.5m fluid and air hoses in one single package.

The EOS 10-C18 kit comprises of the pump available in wall-mounted with or without suction rod, the Airmix® Xcite™ 120 bar gun without tip or hoses in one single packaging.

Recommended for small industries to benefit of both Airmix® spray technology advantages and simple and performing EOS pump range.

Economic solution to handle low viscosity materials (up to 500 cps) with a very low motor air consumption and a low volume fluid section for fast color changes with a minimum of product loss.



tripod shown
also available cart mounted

FEATURES	BENEFITS
Small fluid section and suction rod	Less product loss during color-changing and pump flushing
The gun/pump kits work with a compressor of 0.5 HP	Reduction of operational costs
Simple design , reduced number of spare parts	Easy maintenance
Compact design	Fits in small working areas

SPECIFICATIONS		
Recommended operation with	1 Xcite™ gun equipped with max tip size 09	
Pressure ratio	10:1	
Fluid volume per cycle	0.6 fl oz (18cc)	
Number of cycles per liter of products	55	
Fluid output at 30 cycles/mn	19.4 oz/mn (0.55 L/mn)	
Air consumption at 30 cycles/mn at 58 psi (4 bar)	1.1 cfm (1.9 m³/h)	
Sound pressure level	79.4 dBa	
Free flow rate	38.8 oz/mn (1.1 L/mn)	
Maximum air inlet pressure	87 psi (6 bar)	
Maximum fluid pressure	870 psi (60 bar)	
Maximum fluid temperature	140 °F (60 °C)	
Sealing packings	Upper sealing	Stainless steel cartridge with GT sealing
	Lower sealing	PFA single cup seal
Xcite™ gun weight	17.5 oz / 498 g	
EOS 10-C18 Weight (w/o support or rods)	12 lbs (5.45 kg)	
Wetted parts	Hard chrome stainless steel, treated stainless steel, stainless steel	
Dimensions (H X W X D)	15.8" x 11.4" x 7.1" (400mm x 290mm x 180mm)	

FITTINGS		
Fitting	Air inlet (valve)	F 3/8 BSP
	Air outlet (atomization air)	M 1/4" NPS
	Fluid inlet	F 1/2" JIC / M 26 x 125
	Fluid outlet	M 1/2" JIC

EOS 10-C18 PUMP & XCITE™



CONFIGURATION OF THE EOS 15-C25 PUMP - STAINLESS STEEL

Set-up	Suction rod	Drain rod	Atomization air regulator	Fluid pressure regulator	Filter pump outlet	Part number
Wall-mounted 15-C25	-	-	●	●	-	151-140-000
Wall-mounted 15-C25 with suction rod	5/8" Ø16	-	●	●	-	151-140-100

STAND, CART, GRAVITY HOPPER AND RODS (SUCTION AND FLUSHING)

Description	Part number
Wall-mounted bracket for EOS	151-140-240
Stand for EOS pump	151-140-210
Single post cart for EOS pump	151-140-220
Gravity hopper 1.6 gal (6 liter)	151-140-230
Easyflow suction rod 5/8" Ø16 plunging tube length 23.6 in (600 mm)	149-596-050
Easyflow suction rod 5/8" Ø16 plunging tube length 39.4 in (1000 mm) for 55 gal (200 liter) drums	149-596-060
Easyflow suction rod, 5 gal	149-596-150
Easyflow suction rod, 55 gal	149-596-160
Stainless steel flushing rod F18 x 125	049-596-000

PART NUMBERS

Description	Part number
PUMP,10-C18,W/M,W/O XCITE 120, C/W 5 GALLON ROD(18/125)	668-665-750
SYSTEM,10-C18,W/M,C/W XCITE 120 5G ROD(18/125), 25FT,09-114	668-665-751
SYSTEM,10-C18,W/M,C/W XCITE 120 55G ROD(18/125), 25FT,09-114	668-665-752
SYSTEM,10-C18,W/M,C/W XCITE 120 5G ROD(26/125), 25FT,09-114	668-665-753
SYSTEM,10-C18,W/M,C/W XCITE 120 55G ROD(26/125), 25FT,09-114	668-665-754
SYSTEM,10-C18,W/M,C/W XCITE 120 5G ROD(18/125), 50FT,09-114	668-665-755
SYSTEM,10-C18,W/M,C/W XCITE 120 55G ROD(18/125), 50FT,09-114	668-665-756
SYSTEM,10-C18,W/M,C/W XCITE 120 5G ROD(26/125), 50FT,09-114	668-665-757
SYSTEM,10-C18,W/M,C/W XCITE 120 55G ROD(26/125), 50FT,09-114	668-665-758
SYSTEM,10-C18,C/M,C/W XCITE 120 5G ROD(18/125), 25FT,09-114	668-665-759
SYSTEM,10-C18,C/M,C/W XCITE 120 5G ROD(26/125), 25FT,09-114	668-665-760
SYSTEM,10-C18,C/M,C/W XCITE 120 5G ROD(18/125), 50FT,09-114	668-665-761
SYSTEM,10-C18,C/M,C/W XCITE 120 5G ROD(26/125), 50FT,09-114	668-665-762
SYSTEM,10-C18,W/M,C/W XCITE 120 1G ROD, 16FT,09-114	668-665-763
SYSTEM,10-C18,W/M,C/W XCITE 120 1G ROD, 25FT,09-114	668-665-764
SYSTEM,10-C18,T/P,C/W XCITE 120 1G ROD, 16FT,09-114	668-665-765
SYSTEM,10-C18,T/P,C/W XCITE 120 1G ROD, 25FT,09-114	668-665-766
SYSTEM,10-C18,W/M,C/W XCITE 120 1G ROD(18/125), 25FT,09-114	668-665-767



EOS 15-C25 PUMP

True accelerator of performance for your AIRMIX® Xcite™ gun, the new Kremlin Rexson EOS range combines Efficiency, Optimization and Simplicity.

The innovative design and quality components allow for very simple maintenance, easy cleaning and safe color changes while using a minimum amount of solvents. This results in reduced cost of ownership

The new air motor design allows a smooth start-up under low pressure air and controlled fluid output, without any pulsation at the gun. Very low air consumption. The EOS pump requires very low CFM to operate efficiently.

The latest generation paints developed for the industrial market are handled by the EOS pumps stainless steel construction.

The EOS pump range is available in wall-mounted versions with air control panel. A large choice of accessories (cart, tripod, fluid filter, suction rods) are available to fit any customer need.



FEATURES	BENEFITS
Efficiency: Closed lubricating cup	Lubricant protection against external contamination Full operator safety
Efficiency: Stainless steel construction	Compatible with water-based & solvent materials
Efficiency: Balanced stroke fluid section	Steady output without any pulsation
Efficiency: Large suction valve	Recommended for materials up to 5,000 cps
Optimization: Compact design	Fits in small working areas Cart, Wall or Stand mounted
Optimization: Pump operates at 6 psi	Lower pressures for stain applications
Optimization: New filter	Delivers optimum filtration to prevent tip blockages
Optimization: New suction rods (16 mm and 25 mm diameter)	16 mm: recommended for frequent color changes 25 mm: recommended for high viscosity products up to 5,000 cps
Simplicity: Simple design, reduced number of spare parts	Very easy and economical to maintain
Simplicity: Simple and accessible air motor/fluid section coupling without tie rod	Pump servicing is quick and simple
Simplicity: Fluid section with a mobile lower single lip self-adjusting packing	Delivers better sealing and longer working life. It is also better suited for pre-catalyzed materials and needs less solvent to flush than fixed-packing pumps.
Simplicity: Differential air motor	Quiet efficient operation

SPECIFICATIONS		
Pressure ratio	15:1	
Fluid volume per cycle (cm ³)	25 (2 x 12.5)	
Number of cycles per 33.8 oz (1 liter) of products	40	
Fluid output at 30 cycles/mn	25 oz/mn (0.75 L/mn)	
Air consumption at 30 cycles/mn at 58 psi (4 bar)	1.65 cfm (2.8 m ³ /h)	
Free flow rate	0.4 gal/mn (1.5 L/mn)	
Maximum air inlet pressure	94 psi (6.5 bar)	
Maximum fluid pressure	1414 psi (97.5 bar)	
Maximum fluid temperature	140°F (60°C)	
Sound pressure level	71.2 dBA	
Sealing packings	Upper sealing	Stainless steel cartridge with GT sealing
	Lower sealing	UHMW polyethylene seal
Weight (w/o support or rods)	16.7 lbs. (7.6 kg)	
Wetted parts	hard chrome stainless steel, treated stainless steel, stainless steel	
Height - bare pump	23 in (58.5 cm)	
Width - bare pump	6.2 in (15.8 cm)	
Depth - bare pump	6.7 in (17 cm)	

FITTINGS		
Fitting	Air inlet (valve)	F 3/8 BSP
	Air outlet (atomization air)	M 1/4" NPS
	Fluid inlet	M 26 x 125
	Fluid outlet	#5 JIC

EOS 15-C25 PUMP

CONFIGURATION OF THE EOS 15-C25 PUMP - STAINLESS STEEL

Set-up	Suction rod	Drain rod	Atomization air regulator	Fluid pressure regulator	Filter pump outlet	Part number
Wall-mounted 15-C25	-	-	●	●	-	151-140-000
Wall-mounted 15-C25 with suction rod	5/8" Ø16	-	●	●	-	151-140-100

STAND, CART, GRAVITY HOPPER AND RODS (SUCTION AND FLUSHING)

Description	Part number
Wall-mounted bracket for EOS	151-140-240
Stand for EOS pump	151-140-210
Single post cart for EOS pump	151-140-220
Gravity hopper 1.6 gal (6 liter)	151-140-230
Easyflow suction rod 5/8" Ø16 plunging tube length 23.6 in (600 mm)	149-596-050
Easyflow suction rod 5/8" Ø16 plunging tube length 39.4 in (1000 mm) for 55 gal (200 liter) drums	149-596-060
Easyflow suction rod, 5 gal	149-596-150
Easyflow suction rod, 55 gal	149-596-160
Stainless steel flushing rod F18 x 125	049-596-000

PART NUMBERS

Description	Part number
System, EOS 15-C25, w/m, c/w Xcite™ 120, 5 gallon rod	668-140-000
System, EOS 15-C25, w/m, c/w Xcite™ 120, 5 gallon rod, filter	668-140-001
Pump, EOS 15-C25, w/m, c/w 5 gallon rod, filter	668-140-002
System, EOS 15-C25, w/m, c/w Xcite™ 120, 5 gallon rod, 50 ft hose	668-140-003
System, EOS 15-C25, cart mount, c/w Xcite™ 120, 5 gallon rod	668-140-100
System, EOS 15-C25, cart mount, c/w Xcite™ 120, 5 gallon rod, filter	668-140-101
System, EOS 15-C25, cart mount, c/w Xcite™ 120, hopper kit	668-140-102
System, EOS 15-C25, cart mount, c/w Xcite™ 120, filter, hopper kit	668-140-103
System, EOS 15-C25, cart mount, c/w Xcite™ 120, 5 gallon rod, 50 ft hose	668-140-104
System, EOS 15-C25, stand, c/w Xcite™ 120, 5 gallon rod	668-140-200
System, EOS 15-C25, stand, c/w Xcite™ 120, 5 gallon rod, filter	668-140-201
System, EOS 15-C25, stand, c/w Xcite™ 120, hopper kit	668-140-202
System, EOS 15-C25, stand, c/w Xcite™ 120, filter, hopper kit	668-140-203
System, EOS 15-C25, w/m, c/w Xcite™ 120, 5 gallon rod, filter without swivel	668-140-700
System, EOS 15-C25, w/m, c/w Xcite™ 120, 5 gallon rod, without swivel	668-140-701
System, EOS 15-C25, w/m, c/w Xcite™ 120, 5 gallon rod (ergo kit)	668-140-800



EOS 30-C25 PUMP

True accelerator of performance for your AIRMIX® Xcite™ gun, the new Kremlin Rexson EOS range combines Efficiency, Optimization and Simplicity.

The innovative design and quality components allow for very simple maintenance, easy cleaning and safe color changes while using a minimum amount of solvents. This results in reduced cost of ownership

The new air motor design allows a smooth start-up under low pressure air and controlled fluid output, without any pulsation at the gun. Very low air consumption. The EOS pump requires very low CFM to operate efficiently.

The latest generation paints developed for the industrial market are handled by the EOS pumps stainless steel construction.

The EOS pump range is available in wall-mounted versions with air control panel. A large choice of accessories (cart, tripod, fluid filter, suction rods) are available to fit any customer need.



FEATURES	BENEFITS
Efficiency: Closed lubricating cup	Lubricant protection against external contamination Full operator safety
Efficiency: Stainless steel construction	Compatible with water-based & solvent materials
Efficiency: Balanced stroke fluid section	Steady output without any pulsation
Efficiency: Large suction valve	Recommended for materials up to 5,000 cps
Optimization: Compact design	Fits in small working areas Cart, Wall or Stand mounted
Optimization: Pump operates at 6 psi	Lower pressures for stain applications
Optimization: New filter	Delivers optimum filtration to prevent tip blockages
Optimization: New suction rods (16 mm and 25 mm diameter)	16 mm: recommended for frequent color changes 25 mm: recommended for high viscosity products up to 5,000 cps
Simplicity: Simple design, reduced number of spare parts	Very easy and economical to maintain
Simplicity: Simple and accessible air motor/fluid section coupling without tie rod	Pump servicing is quick and simple
Simplicity: Fluid section with a mobile lower single lip self-adjusting packing	Delivers better sealing and longer working life. It is also better suited for pre-catalyzed materials and needs less solvent to flush than fixed-packing pumps.
Simplicity: Differential air motor	Quiet efficient operation

SPECIFICATIONS	
Pressure ratio	30:1
Fluid volume per cycle (cm³)	25 (2 x 12.5)
Number of cycles per 33.8 oz (1 liter) of products	40
Fluid output at 30 cycles/mn (L/mn)	25 oz/mn (0.75 L/mn)
Air consumption at 30 cycles/mn at 85 psi (4 bar)	4.2 cfm (7.1 m³/h)
Free flow rate	0.4 gal/mn (1.5 L/mn)
Maximum air inlet pressure	94 psi (6.5 bar)
Maximum fluid pressure	2827 psi (195 bar)
Maximum fluid temperature	140°F (60°C)
Sound pressure level	74.9 dBA
Sealing packings	Upper sealing: Stainless steel cartridge with GT sealing Lower sealing: UHMW polyethylene seal
Weight (kg) (w/o support or rods)	16.7 lbs. (7.6 kg)
Wetted parts	Hard chrome stainless steel, treated stainless steel, stainless steel
Height - bare pump	23 in (58.5 cm)
Width - bare pump	6.2 in (15.8 cm)
Depth - bare pump	6.7 in (17 cm)

FITTINGS		
Fitting	Air inlet (valve)	F 3/8 BSP
	Air outlet (atomization air)	M 1/4" NPS
	Fluid inlet	M 26 x 125
	Fluid outlet	#5 JIC

EOS 30-C25 PUMP

CONFIGURATION OF THE EOS 30-C25 PUMP - STAINLESS STEEL

Set-up	Suction rod	Drain rod	Atomization air regulator	Fluid pressure regulator	Filter pump outlet	Part number
30-C25 wall-mounted pump	-	-	●	●	-	151-145-000
30-C25 wall-mounted pump with rod	5/8" Ø16	-	●	●	-	151-145-100
30-C25 wall-mounted pump with rod	Ø 25	-	●	●	-	151-145-150
30-C25 wall-mounted pump with rod and filter	Ø 25	-	●	●	●	151-145-250

STAND, CART, GRAVITY HOPPER AND RODS (SUCTION AND FLUSHING)

Description	Part number
Wall-mounted bracket for EOS	151-140-240
Stand for EOS pumps	151-140-210
Single post cart for EOS pumps	151-140-220
Gravity Hopper 1.6 gal (6 liter)	151-140-230
Easyflow suction rod 5/8" Ø16 plunging tube length 23.6 in (600 mm)	149-596-050
Easyflow suction rod 5/8" Ø16 plunging tube length 39.4 in (1000 mm) 550 gal (for 200 liters drums)	149-596-060
Easyflow suction rod, 5 gal	149-596-150
Easyflow suction rod, 55 gal	149-596-160
Stainless steel flushing rod F18 x 125	049-596-000

PART NUMBERS

Description	Part number
System, EOS 30-C25, w/m, c/w Xcite™ 120, 5 gallon rod	668-145-000
System, EOS 30-C25, cart mount, c/w Xcite™ 200, 5 gallon rod	668-145-100
System, EOS 30-C25, w/m, c/w Xcite™ 200, 5 gallon rod, filter	668-145-001
Pump, EOS 30-C25, w/m, c/w 5 gallon rod, filter	668-145-002
System, EOS 30-C25, w/m, c/w Xcite™ 200, 5 gallon rod, filter, 50 ft	668-145-004
System, EOS 30-C25, w/m, c/w Xcite™ 200, 5 gallon rod (e-flow)	668-145-010
System, EOS 30-C25, w/m, c/w Xcite™ 200, 5 gallon rod, filter (e-flow)	668-145-011
Pump, EOS 30-C25, w/m, c/w 5 gallon rod, filter (e-flow)	668-145-012
System, EOS 30-C25, cart mount, c/w Xcite™ 200, hopper kit	668-145-102
System, EOS 30-C25, cart mount, c/w Xcite™ 200, filter, hopper kit	668-145-103
System, EOS 30-C25, cart mount, c/w Xcite™ 200, 5 gallon rod (e-flow)	668-145-110
System, EOS 30-C25, cart mount, c/w Xcite™ 200, 5 gallon rod, filter (e-flow)	668-145-111
System, EOS 30-C25, stand, c/w Xcite™ 200, 5 gallon rod	668-145-200
System, EOS 30-C25, stand, c/w Xcite™ 200, 5 gallon rod, filter	668-145-201
System, EOS 30-C25, stand, c/w Xcite™ 200, hopper kit	668-145-202
System, EOS 30-C25, stand, c/w Xcite™ 200, filter, hopper kit	668-145-203
System, EOS 30-C25, stand, c/w Xcite™ 200, 5 gallon rod, 50 ft hoses	668-145-204
System, EOS 30-C25, stand, c/w Xcite™ 200, 5 gallon rod (e-flow)	668-145-210



10.25 GT PUMP

Ideal for water-based and high solids materials

FEATURES	BENEFITS
Large diameter suction rod and high compression ratio	Can be used with a wide range of materials
Stainless steel construction	Compatible with water-based materials
Simple design, reduced number of spare parts	Easy maintenance

SPECIFICATIONS	
Pressure ratio	10:1
Fluid volume per cycle	(50 cm ³)
Number of cycles per 33.8 oz (1 liter) of product	20
Fluid output at 30 cycles/mn	0.4 gal/mn (1.5 L/mn)
Free flow rate	.8 gal/mn (3 L/mn)
Air consumption at 30 cycles/mn at 85 psi (4 bar)	6.4 cfm (10.8 m ³ /h)
Maximum air inlet pressure	87 psi (6 bar)
Maximum fluid pressure	870 psi (60 bar)
Maximum fluid temperature	140°F (60°C)
Sound level	82 dBA
Sealing packings	Upper sealing Lower sealing
	GT seal cartridge GT seal
Weight	37.5 lbs (17 kg)
Wetted parts	Stainless steel
Height	32.3 in (83 cm)
Width	13.8 in (35 cm)
Depth	8.3 in (21 cm)

FITTINGS		
Fitting	Air inlet (valve)	F 3/8" BSP
	Air outlet (atomization air)	M 1/4" NPS
	Fluid inlet	M 26 x 125
	Fluid output (filter)	M #5 JIC



Model shown on a two-arm cart

CONFIGURATION OF 10.25 GT PUMPS

Set-up	Sealing packings		Suction rod	Drain rod	Atomization air regulator	Air regulator Fluid pressure	Pump output filter	Part number
	Lower sealing	Upper sealing						
Wall mounted GT seals	GT seal	GT seal	-	-	●	●	-	151-777-200
Wall mounted GT seals	GT seal	GT seal	●	●	●	●	●	151-777-100

KITS

Description	Part number
H25 GT seal kit	144-950-091
H25 GT repair kit	144-950-096
250-4 air motor seal kit	146-260-991
250-4 air motor maintenance kit	146-260-996

CART, GRAVITY HOPPER AND RODS (SUCTION AND FLUSHING)

Description	Part number
Single post cart	051-730-110
Two post cart w/o plate	051-221-000
Two post pump mounting plate	056-100-199
Gravity hopper 1.6 gal (6 liters)	151-140-230
Easyflow suction rod, 5 gal	149-596-150
Easyflow suction rod, 55 gal	149-596-160
Stainless steel flushing rod F18 x 125	049-596-000

PART NUMBERS

Description	Part number
System, 10-25, w/m, c/w Xcite™ 120, 5 gallon rod, 09-094	668-777-100
System, 10-25, w/m, c/w Xcite™ 120, 55 gallon rod, 09-094	668-777-101



20.25 PUMP

Ideal for water-based and high solids materials

FEATURES	BENEFITS
Large diameter suction rod and high compression ratio	Can be used with a wide range of materials
Stainless steel construction	Compatible with water-based materials
Simple design, reduced number of spare parts	Easy maintenance

SPECIFICATIONS		
Pressure ratio	20:1	
Fluid volume per cycle	(50 cm ³)	
Number of cycles per 33.8 oz (1 liter) of product	20	
Fluid output at 30 cycles/mn	0.4 gal/mn (1.5 L/mn)	
Free flow rate	.8 gal/mn (3 L/mn)	
Air consumption (m ³ /h) at 30 cycles/mn at 4 bar	6.4 cfm (10.8 m ³ /h)	
Maximum air inlet pressure	87 psi (6 bar)	
Maximum fluid pressure	1740 psi (120 bar)	
Maximum fluid temperature	140°F (60°C)	
Sound level	78 dBA	
Sealing packings	Upper sealing	Polyfluid + PTFE G or GT seal
	Lower sealing	GT sealing
Weight	37.5 lbs (17 kg)	
Wetted parts	Stainless steel	
Height	32.3 in (83 cm)	
Width	13.8 in (35 cm)	
Depth	8.3 in (21 cm)	

FITTINGS		
Fitting	Air inlet (valve)	F 3/8" BSP
	Air outlet (atomization air)	M 1/4" NPS
	Fluid inlet	M 26 x 125
	Fluid output (filter)	M #5 JIC



Model shown on a two-arm cart

CONFIGURATION OF AIRMIX® 20.25 PUMPS								
Set-up	Sealing packings		Suction rod	Drain rod	Atomization air regulator	Air regulator Fluid pressure	Pump output filter	Part number
	Lower sealing	Upper sealing						
Wall mounted	GT seal	Polyfluid + PTFE G	●	-	●	●	-	151-773-200
Wall mounted (GT seal)	GT seal	GT seal	●	●	●	●	●	151-773-100

KITS	
Description	Part number
H25 GT seal kit	144-950-091
H25 GT repair kit	144-950-096
Seal kit for 500-4 air motor	146-260-990
Repair kit for 500-4 air motor	146-260-995

CART, GRAVITY HOPPER AND RODS (SUCTION AND FLUSHING)	
Description	Part number
Single post cart	051-730-110
Two post cart w/o plate	051-221-000
Two post pump mounting plate	056-100-199
Gravity hopper 1.6 gal (6 liters)	151-140-230
Easyflow suction rod, 5 gal	149-596-150
Easyflow suction rod, 55 gal	149-596-160
Stainless steel flushing rod F18 x 125	049-596-000

PART NUMBERS	
Description	Part number
System, 20-25, w/m, c/w Xcite™ 120, 5 gallon rod, 09-094	668-773-100
System, 20-25, w/m, c/w Xcite™ 120, 55 gallon rod, 09-094	668-773-101



20.50 & 20.50T PUMP

The 20.50 pump is ideal for water-based and high solid materials. The Turbo air motor is recommended for continuous use.

FEATURES	BENEFITS
Simple design, reduced number of spare parts	Easy maintenance
Large diameter suction rod and high compression ratio	Can be used with a wide range of materials
Stainless steel construction	Compatible with water-based products

SPECIFICATIONS		
Pressure ratio	20/1	
Fluid volume per cycle	(100 cm ³)	
Number of cycles per 33.8 oz (1 liter) of product	10	
Fluid output at 30 cycles/mn	0.8 gal/mn (3 L/mn)	
Free flow rate	1.6 gal/mn (6 L/mn)	
Air consumption at 30 cycles/mn at 85 psi (4 bar)	12.7 cfm (21.6 m ³ /h)	
Maximum air inlet pressure	87 psi (6 bar)	
Maximum fluid pressure	1740 psi (120 bar)	
Maximum fluid temperature	140°F (60°C)	
Sound level	78 dBA	
Sealing packings	Upper sealing	Polyfluid + PTFE G
	Lower sealing	GT
Weight	48.5 lbs. (22 kg)	
Wetted parts	Stainless steel	
Height	33.8 in (86 cm)	
Width	13.8 in (35 cm)	
Depth	11 in (28 cm)	

FITTINGS		
Fitting	Air inlet (valve)	F 3/8" BSP
	Air outlet (atomization air)	M 1/4" NPS
	Fluid inlet	M 26 x 125
	Fluid output (filter)	M #5 JIC

CONFIGURATION OF AIRMIX® 20.50 PUMPS						
Set-up	Suction rod	Drain rod	Atomization air regulator	Air regulator Fluid pressure	Pump output filter	Part number
Wall mounted	●	-	●	●	-	151-780-100
Wall mounted	●	●	●	●	●	151-780-200
Turbo wall mounted	-	-	●	●	-	151-782-100
Turbo Wall mounted	●	●	●	●	●	151-782-200

KITS	
Description	Part number
H50 GT seal kit	144-960-091
H50 GT repair kit	144-960-096
Seal kit for 1000-4 air motor	146-270-991
Repair kit for 1000-4 air motor	146-270-995

CART AND RODS (SUCTION AND FLUSHING)	
Description	Part number
Single post cart	051-730-110
Two post cart w/o plate	051-221-000
Two post pump mounting plate	056-100-199
Easyflow suction rod, 5 gal	149-596-150
Easyflow suction rod, 55 gal	149-596-160
Stainless steel flushing rod F18 x 125	049-596-000





40.25 PUMP

Ideal for outputs up to 0.4 gal/mn (1.5 liter/mn)

FEATURES	BENEFITS
Large diameter suction rod and high compression ratio	Can be used with a wide range of materials
Stainless steel construction	Compatible with water-based products
Simple design, reduced number of spare parts	Easy maintenance

SPECIFICATIONS	
Pressure ratio	40:1
Fluid volume per cycle	(50 cm ³)
Number of cycles per 33.8 oz (1 liter) of products	20
Fluid output at 30 cycles/mn	0.4 gal/mn (1.5 L/mn)
Air consumption at 30 cycles/mn at 85 psi (4 bar)	12.7 cfm (21.6 m ³ /h)
Free flow rate	0.8 gal/mn (3 L/mn)
Maximum air inlet pressure	87 psi (6 bar)
Maximum fluid pressure	3480 psi (240 bar)
Maximum fluid temperature	140°F (60°C)
Sound level	77 dBA
Sealing packings	Upper sealing Polyfluid + PTFE G Lower sealing GT seal
Wetted parts	Stainless steel
Weight - wall-mounted	48 lbs. (22 kg)
Height	31.5 in (80 cm)
Width	15.7 in (40 cm)
Depth	11 in (28 cm)

FITTINGS		
Fitting	Air inlet (valve)	F 3/4" BSP
	Air outlet (option atomization air kit)	M 1/4" NPS
	Fluid inlet	M 26x125
	Fluid output (filter)	M #5 JIC



CONFIGURATION OF THE 40.25 PUMP -STAINLESS STEEL					
Set-up	Suction rod	Drain rod	Air regulator Fluid pressure	Pump output filter	Part number
Wall mounted	●	-	●	-	151-775-100
Wall mounted	●	●	●	●	151-775-200
2 arm cart mounted	●	●	●	●	151-775-400

ATOMIZATION AIR KIT WITH REGULATOR	
Description	Part number
Atomization air kit with regulator (for AIRMIX® spray guns)	151-740-200

KITS	
Description	Part number
H25 GT seal kit	144-950-091
H25 GT repair kit	144-950-096
Seal kit for 1000-4 air motor	146-270-991
Repair kit for 1000-4 air motor	146-270-995

CARTS AND RODS (SUCTION AND FLUSHING)	
Description	Part number
Two post cart w/o plate	051-221-000
Two post pump mounting plate	056-100-199
Easyflow suction rod, 5 gal	149-596-150
Easyflow suction rod, 55 gal	149-596-160
Stainless steel flushing rod F18 x 125	049-596-000



40.25 WB PUMP (WATER-BASED)



Recommended for high viscosity products such as water-based and high solid paints. Ideal for outputs up to 0.4 gal/mn (1.5 liter/mn).

FEATURES	BENEFITS
Large suction fluid passage	For high viscosity materials
Prevent any pulsation which might alter the flow rate	Stable and smooth flow
Stainless steel construction	Compatible with water-based products
Stainless steel strainer	Long service life and good reliability No crushing possible
Simple design, reduced number of spare parts	Easy maintenance

SPECIFICATIONS		
Pressure ratio	40:1	
Fluid volume per cycle	(50 cm ³)	
Number of cycles per 33.8 oz (1 liter) of products	20	
Fluid output at 30 cycles/mn	0.4 gal/mn (1.5 L/mn)	
Air consumption at 30 cycles/mn at 85 psi (4 bar)	12.7 cfm (21.6 m ³ /h)	
Free flow rate	0.8 gal/mn (3 L/mn)	
Maximum air inlet pressure	87 psi (6 bar)	
Maximum fluid pressure	3480 psi (240 bar)	
Maximum fluid temperature	140°F (60°C)	
Sound level	77 dBA	
Sealing packings	Upper sealing	Polyfluid + PTFE G
	Lower sealing	GT seal
Wetted parts	Stainless steel	
Weight - wall-mounted	48.5 lbs. (22 kg)	
Height	36.2 in (92 cm)	
Width	15.7 in (40 cm)	
Depth	11 in (28 cm)	

FITTINGS		
Fitting	Air inlet (valve)	F 3/4" BSP
	Air outlet (option atomization air kit)	M 1/4" NPS
	Fluid inlet	M 1"
	Fluid output (filter)	M #5 JIC



CONFIGURATION OF THE 40.25 WB PUMP - STAINLESS STEEL

Set-up	Suction rod	Drain rod	Air regulator Fluid pressure	Pump output filter	Part number
Wall mounted	●	●	●	●	151-775-550
2 arm cart mounted	●	●	●	●	151-775-500

ATOMIZATION AIR KIT WITH REGULATOR

Description	Part number
Atomization air kit with regulator (for AIRMIX® spray guns)	151-740-200

KITS

Description	Part number
H25 WB seal kit	144-950-991
Repair kit H25 WB	144-950-992
Seal kit for 1000-4 air motor	146-270-991
Repair kit for 1000-4 air motor	146-270-995

CARTS AND RODS (SUCTION OR FLUSHING)

Description	Part number
Two post cart w/o plate	051-221-000
Two post pump mounting plate	056-100-199
Suction rod 1"	921-270-101
Stainless steel flushing rod F18 x 125	049-596-000



40.50 PUMP

Ideal for feeding two guns.

FEATURES	BENEFITS
Simple design, reduced number of spare parts	Easy maintenance
Large diameter suction rod and high compression ratio	Can be used with a wide range of materials

SPECIFICATIONS		
Pressure ratio	40:1	
Fluid volume per cycle	(100 cm ³)	
Number of cycles per 33.8 oz (1 liter) of products	10	
Fluid output at 30 cycles/mn	0.8 gal/mn (3 L/mn)	
Free flow rate	1.6 gal/mn (6 L/mn)	
Air consumption at 30 cycles/mn at 85 psi (4 bar)	25.3 cfm (43.2 m ³ /h)	
Maximum air inlet pressure	87 psi (6 bar)	
Maximum fluid pressure	3480 psi (240 bar)	
Maximum fluid temperature	140°F (60°C)	
Sound level	80 dBA	
Sealing packings	Upper sealing	Polyfluid + PTFE G
	Lower sealing	GT sealing
Wetted parts	Stainless steel	
Weight - wall-mounted	48.5 lbs. (22 kg)	
Height	80	
Width	15.7 in (40 cm)	
Depth	11 in (28 cm)	

FITTINGS		
Fitting	Air inlet (valve)	F 3/4" BSP
	Air outlet (option atomization air kit)	M 1/4" NPS
	Fluid inlet	M 26 x 125
	Fluid output (filter)	M #5 JIC



CONFIGURATION OF THE 40.50 PUMP - STAINLESS STEEL					
Set-up	Suction rod	Drain rod	Air regulator Fluid pressure	Pump output filter	Part number
Wall mounted	●	-	●	-	151-785-100
Wall mounted	●	●	●	●	151-785-200
2 arm cart mounted	●	●	●	●	151-785-400

ATOMIZATION AIR KIT WITH REGULATOR	
Description	Part number
Atomization air kit with regulator (for AIRMIX® spray guns)	151-740-200

KITS	
Description	Part number
H50 GT seal kit	144-960-091
H50 GT repair kit	144-960-096
Seal kit for 2000-4 air motor	146-270-990
Repair kit for 2000-4 air motor	146-270-996

CARTS AND RODS (SUCTION AND FLUSHING)	
Description	Part number
Two post cart w/o plate	051-221-000
Two post pump mounting plate	056-100-199
Easyflow suction rod, 5 gal	149-596-150
Easyflow suction rod, 55 gal	149-596-160
Stainless steel flushing rod F18 x 125	049-596-000



40.50 WB PUMP (WATER-BASED)

FEATURES	BENEFITS
Large suction fluid passage	For high viscosity materials
Prevent any pulsation which might alter the flow rate	Stable and smooth flow
Stainless steel construction	Compatible with water-based products
Stainless steel strainer	Long service life and good reliability No crushing possible
Simple design, reduced number of spare parts	Easy maintenance

SPECIFICATIONS		
Pressure ratio	40:1	
Fluid volume per cycle	(100 cm ³)	
Number of cycles per 33.8 oz (1 liter) of products	10	
Fluid output at 30 cycles/mn	0.8 gal/mn (3 L/mn)	
Air consumption at 30 cycles/mn at 85 psi (4 bar)	25.5 cfm (43.2 m ³ /h)	
Free flow rate	1.6 gal (6 L/mn)	
Maximum air inlet pressure	87 psi (6 bar)	
Maximum fluid pressure	3480 psi (240 bar)	
Maximum fluid temperature	140°F (60°C)	
Sound level	80 dBA	
Sealing packings	Upper sealing	Polyfluid + PTFE G
	Lower sealing	GT seal
Wetted parts	Stainless steel	
Weight - wall-mounted	48.5 lbs. (22 kg)	
Height	36.2 in (92 cm)	
Width	15.7 in (40 cm)	
Depth	11 in (28 cm)	

FITTINGS		
Fitting	Air inlet (valve)	F 3/4" BSP
	Air outlet (option atomization air kit)	M 1/4" NPS
	Fluid inlet	M 1"
	Fluid output (filter)	M #8 JIC



CONFIGURATION OF THE 40.50 WB PUMP -STAINLESS STEEL

Set-up	Suction rod	Drain rod	Air regulator Fluid pressure	Pump output filter	Part number
Wall mounted	●	●	●	●	151-785-550
2 arm cart mounted	●	●	●	●	151-785-500

FITTING TO CONNECT A XCITE™ GUN KIT

Description	Part number
Adaptator stainless steel F #8 JICart mount #5 JIC	905-160-219

ATOMIZATION KIT

Description	Part number
Atomization air kit with regulator (for AIRMIX® spray guns)	151-740-200

KITS

Description	Part number
H50 WB seal kit	144-960-891
H50 WB repair kit	144-960-892
Seal kit for 2000-4 air motor	146-270-990
Repair kit for 2000-4 air motor	146-270-996

CARTS AND RODS (SUCTION AND FLUSHING)

Description	Part number
Two post cart w/o plate	051-221-000
Two post pump mounting plate	056-100-199
Suction rod 1"	921-270-101
Stainless steel flushing rod F18 x 125	049-596-000



17.A2 FLOWMAX® PUMP

A unique design with external check valves for easy maintenance. Flowmax® technology ensures air tight sealing. The air motor offers quick change over for pulse feel operation at the gun. Great for UV and moisture sensitive materials. Performance and reliability.

FEATURES	BENEFITS
External valves assembly	Easy maintenance
Floating piston	Fast inversions and very high efficiency
Sealing ensured by a Superlife™ Bellows seal	High reliability No more lubricant cups Leak free Total sealing between pump and its environment Ideal to work with moisture-sensitive catalysts Ideal for UV and pre-catalyzed materials
Stainless steel construction	Compatible with water-based materials
Large and smooth fluid passages	Fluid discharge without retention of a wide range of coating materials
Balanced fluid section	Constant fluid output pressure

SPECIFICATIONS		
Pressure ratio	17:1	
Fluid volume per cycle	(60 cm ³)	
Number of cycles per 33.8 oz (1 liter) of products	16	
Fluid output at 30 cycles/mn	0.48 gal/mn (1.8 L/mn)	
Free flow rate	0.95 gal/mn (3.6 L/mn)	
Air consumption at 30 cycles/mn at 85 psi (4 bar)	6.5 cfm (11 m ³ /h)	
Maximum air inlet pressure	87 psi (6 bar)	
Maximum fluid pressure	1450 psi (100 bar)	
Maximum fluid temperature	122°F (50°C)	
Sound level	74	
Sealing packing	Bellows	Polyethylene
	Upper and lower	GT polyethylene
Weight - wall-mounted	44 lbs (20 kg)	
Wetted parts	Stainless steel	
Height	24.5 in (62.2 cm)	
Width	13 in (33 cm)	
Depth	8.2 in (21 cm)	

FITTINGS	
Air inlet (valve)	F 3/8" BSP
Air outlet (atomization air)	M 1/4" NPS
Fluid inlet	M 26 x 125
Fluid output (filter)	#5 JIC



CONFIGURATION OF THE FLOWMAX® AIRMIX® 17.A2 PUMP

Set-up	Suction rod	Drain rod	Atomization air regulator	Air regulator Fluid pressure	Pump output filter	Part number
Wall-mounted 17.A2 Flowmax® pump	●	●	●	●	●	151-730-700
1 arm cart 17.A2 Flowmax® pump	●	●	●	●	●	151-730-750

PART NUMBER

Description	Part number
System, 17.A2, w/m, c/w Xcite™120, 5 gallon rod, 09-094	668-730-700
System, 17.A2, w/m, c/w Xcite™120, 55 gallon ,09-094	668-730-701
System, Electro, 17.A2, w.m, KMX3 5 gallon rod	668-730-704
Pump, 17.A2, w/m, c/w filter 55 gal. rod	668-730-710
Pump, 17.A2, w/m, c/w filter w/o suction	668-730-711
System, 17.A2, c/m, c/w Xcite™120, 5 gallon rod, 09-094	668-730-750
System, Electro, 17.A2, KMX3, 50 ft hoses, 5 gallon rod	668-730-755

17.A2 FLOWMAX® PUMP

CARTS AND RODS (SUCTION AND FLUSHING)

Description	Part number
Single post cart	051-730-110
Two post cart w/o plate	051-221-000
Two post pump mounting plate	056-100-199
Easyflow suction rod, 5 gal	149-596-150
Easyflow suction rod, 55 gal	149-596-160
Stainless steel flushing rod F18 x 125	049-596-000

KITS

Description	Part number
Seal kit for A2 fluid section	144-910-799
Repair kit for A2 fluid section	144-910-797
Seal kit for external valves	144-910-798
Seal kit for 1000-2 air motor	144-919-904
Repair kit for 1000-2 air motor	144-919-914



20.25F FLOWMAX® PUMP

Universal AIRMIX® pump for use with all materials, including water-based and high solids.

FEATURES	BENEFITS
Sealing done by one large stroke Bellows	High reliability No more lubricant cups Leak free Total sealing between pump and its environment Ideal to work with moisture-sensitive catalysts Ideal for UV and pre-catalyzed materials
Ergonomic design of fluid passages	Fluid discharge without retention of a wide range of coating materials
Stainless steel construction	Compatible with water-based materials
Balanced fluid section	Constant fluid output pressure
Mobile piston seal	Excellent suction capacity

SPECIFICATIONS	
Pressure ratio	20:1
Fluid volume per cycle	(50 cm ³)
Number of cycles per 33.8 oz (1 liter) of products	20
Fluid output at 30 cycles/mn	0.4 gal/mn (1.5 L/mn)
Free flow rate	0.8 gal/mn (3 L/mn)
Air consumption at 30 cycles/mn at 85 psi (4 bar)	6.4 cfm (10.8 m ³ /h)
Maximum air inlet pressure	87 psi (6 bar)
Maximum fluid pressure	1740 psi (120 bar)
Maximum fluid temperature	122°F (50°C)
Sound level	80 dBA
Sealing packing	Bellows: Polyethylene Upper and lower: GT Polyethylene
Weight - wall-mounted	48.5 lbs (22 kg)
Wetted parts	Stainless steel
Height	39 in (99 cm)
Width	19 in (48 cm)
Depth	11 in (28 cm)

FITTINGS		
Fitting	Air inlet (valve)	F 3/8" BSP
	Air outlet (atomization air)	M 1/4" NPS
	Fluid inlet	M 26 x 125
	Fluid output (filter)	M #5 JIC



CONFIGURATION OF THE FLOWMAX® AIRMIX® 20.25F - STAINLESS STEEL						
Set-up	Suction rod	Drain rod	Atomization air regulator	Air regulator Fluid pressure	Pump output filter	Part number
Wall mounted	●	●	●	●	●	151-771-200
2 arms cart-mounted	●	●	●	●	●	151-771-400

PART NUMBER	
Description	Part number
System, 20-25F, w/m c/w Xcite™ 120, 5 gallon rod, 09-094	668-771-100
System, 20-25F, w/m c/w Xcite™ 120, 55 gallon rod, 09-094	668-771-101
Pump, 20-25F, w/m, c/w filter 55 gal. Rod	668-771-151
Pump, 20-25F, c/w pump air reg, 55 gallon rod, w/o filter	668-771-152

KITS	
Description	Part number
Seal kit H25F	144-950-291
Repair kit H25F	144-950-292
Seal kit for 500-4 air motor	146-260-990
Repair kit for 500-4 air motor	146-260-995

CARTS AND RODS (SUCTION AND FLUSHING)	
Description	Part number
Two post cart w/o plate	051-221-000
Two post pump mounting plate	056-100-199
Easyflow suction rod, 5 gal	149-596-150
Easyflow suction rod, 55 gal	149-596-160
Stainless steel flushing rod F18 x 125	049-596-000



20.50F & 20.50FT FLOWMAX® PUMPS



Universal AIRMIX® pump for use with all materials, including water-based and high solids.

FEATURES	BENEFITS
Sealing done by one large stroke Bellows	High reliability No more lubricant cups Leak free Total sealing between pump and its environment Ideal to work with moisture-sensitive catalysts Ideal for UV and pre-catalyzed materials
Ergonomic design of fluid passages	Fluid discharge without retention of a wide range of coating materials
Stainless steel construction	Compatible with water-based materials
Balanced fluid section	Constant fluid output pressure
Mobile piston seal	Excellent suction capacity

SPECIFICATIONS		
Pressure ratio	20:1	
Fluid volume per cycle (cm ³)	(100 cm ³)	
Number of cycles per 33.8 oz (1 liter) of products	10	
Fluid output at 30 cycles/mn	0.8 gal/mn (3 L/mn)	
Free flow rate	1.6 gal/mn (6 L/mn)	
Air consumption at 30 cycles/mn at 85 psi (4 bar)	12.7 cfm (21.6 m ³ /h)	
Maximum air inlet pressure	87 psi (6 bar)	
Maximum fluid pressure	1740 psi (120 bar)	
Maximum fluid temperature	122°F (50°C)	
Sound level	76 dBA	
Sealing packing	Bellows	Polyethylene
	Upper and lower	GT Polyethylene
Weight - wall-mounted	59.5 lbs (27kg)	
Wetted parts	Stainless steel	
Height	38.4 in (97.5 cm)	
Width	18.5 in (47 cm)	
Depth	10.6 in (27 cm)	

FITTINGS		
Fitting	Air inlet (valve)	F 3/8" BSP
	Air outlet (atomization air)	M 1/4" NPS
	Fluid inlet	M 26 x 125
	Fluid output (filter)	M #5 JIC



20.50FT pictured

CONFIGURATION OF THE FLOWMAX® AIRMIX® 20.50F - STAINLESS STEEL

Set-up	Suction rod	Drain rod	Atomization air regulator	Air regulator Fluid pressure	Pump output filter	Part number
Wall mounted	●	-	●	●	-	151-781-100
Wall mounted	●	●	●	●	●	151-781-200
Turbo Wall mounted	-	-	●	●	-	151-783.100
Turbo Wall mounted	●	●	●	●	●	151-783.200

KITS

Description	Part number
Seal kit H 50F	144-960-291
Repair kit H 50F	144-960-292
Seal kit for 1000-4 air motor	146-270-991
Repair kit for 1000-4 air motor	146-270-995

CARTS AND RODS (SUCTION AND FLUSHING)

Description	Part number
Two post cart w/o plate	051-221-000
Two post pump mounting plate	056-100-199
Easyflow suction rod, 5 gal	149-596-150
Easyflow suction rod, 55 gal	149-596-160
Stainless steel flushing rod F18 x 125	049-596-000



34.A2 FLOWMAX® PUMP

A unique design with external check valves for easy maintenance. Flowmax® technology ensures air tight sealing. The air motor offers quick stroke change over for pulse feel operation at the gun. Great for UV and moisture sensitive materials. Performance and reliability.

FEATURES	BENEFITS
External valves assembly	Easy maintenance
Floating piston	Fast inversions and very high efficiency
Sealing done by a Superlife™ Bellows seal	High reliability No more lubricant cups Leak free Total sealing between pump and its environment Ideal to work with moisture-sensitive catalysts Ideal for UV and pre-catalyzed materials
Large and smooth fluid passages	Fluid discharge without retention of a wide range of coating materials
Stainless steel construction	Compatible with water-based materials
Balanced fluid section	Constant fluid output pressure

SPECIFICATIONS	
Pressure ratio	34:1
Fluid volume per cycle	(60 cm³)
Number of cycles per 33.8 oz (1 liter) of products	16
Fluid output at 30 cycles/mn	0.48 gal/mn (1.8 L/mn)
Air consumption at 30 cycles/mn at 85 psi (4 bar)	12.9 cfm (22 m³/h)
Free flow rate	0.95 gal/mn (3.6 L/mn)
Maximum air inlet pressure	87 psi (6 bar)
Maximum fluid pressure	2900 psi (200 bar)
Maximum fluid temperature	122°F (50°C)
Sound level	71 dBA
Sealing packing	Bellows Upper and lower
	Polyethylene GT (Polyethylene)
Weight - wall-mounted	Inox
Wetted parts	58.4 lbs (26.5 kg)
Height	24 in (61 cm)
Width	16.1 in (41 cm)
Depth	9.8 in (25 cm)

FITTINGS		
Fitting	Air inlet (valve)	F 3/4" BSP
	Air outlet (option atomization air kit)	M 1/4" NPS
	Fluid inlet	M 26 x 125
	Fluid output (filter)	#5 JIC



CONFIGURATION OF THE FLOWMAX® 34.A2 PUMP					
Set-up	Suction rod	Drain rod	Air regulator Fluid pressure	Pump output filter	Part number
Wall-mounted Flowmax® 34.A2	●	●	●	●	151-740-700
1 arm cart Flowmax® 34.A2	●	●	●	●	151-740-750

ATOMIZATION AIR KIT WITH REGULATOR	
Description	Part number
Atomization air kit with regulator (for AIRMIX® spray guns)	151-740-200

KITS	
Description	Part number
Seal kit for A2 fluid section	144-910-799
Repair kit for A2 fluid section	144-910-797
Seal kit for external valves	144-910-798
Seal kit for 2000-2 air motor	144-929-902
Repair kit for 2000-2 air motor	144-929-912

34.A2 FLOWMAX® PUMP

CARTS AND RODS (SUCTION AND FLUSHING)	
Description	Part number
Two post cart w/o plate	051-221-000
Two post pump mounting plate	056-100-199
Easyflow suction rod, 5 gal	149-596-150
Easyflow suction rod, 55 gal	149-596-160
Stainless steel flushing rod F18 x 125	049-596-000

PART NUMBER	
Suction rod	Part number
System, 34.A2,w/m, c/w Xcite™ 200, 5 gallon rod, 09-094	668-740-700
System, 34.A2,w/m, c/w Xcite™ 200, 55 gallon rod, 09-094	668-740-701
Pump, 34.A2, w/m, c/w filter 55 gallon. rod	668-740-702
System, 34.A2, c/m, Xcite™ 200, gun kit, 5 gallon rod	668-740-703



40.25F FLOWMAX® PUMP

New generation Flowmax® pump for low volume applications

FEATURES	BENEFITS
Sealing done by one large stroke Bellows	High reliability No more lubricant cups Leak free Total sealing - ideal for isocyanates Ideal for UV and pre-catalyzed materials
Ergonomic design of fluid passages	Fluid discharge without retention of a wide range of coating materials
Stainless steel construction	Compatible with water-based materials
Balanced fluid section	Constant fluid output pressure
Mobile piston seal	Excellent suction capacity

SPECIFICATIONS		
Pressure ratio	40:1	
Fluid volume per cycle	(50 cm ³)	
Number of cycles per 33.8 oz (1 liter) of products	20	
Air consumption at 30 cycles/mn at 85 psi (4 bar)	12.7 cfm (21.6 m ³ /h)	
Fluid output at 30 cycles/mn	0.4 gal/mn (1.5 L/mn)	
Free flow rate	0.8 gal/mn (3 L/mn)	
Maximum fluid pressure	3480 psi (240 bar)	
Maximum fluid temperature	122°F (50°C)	
Maximum air inlet pressure	87 psi (6 bar)	
Sound level	72 dBA	
Sealing packing	Bellows	Polyethylene
	Upper and lower	GT polyethylene
Wetted parts	Stainless steel	
Weight - wall-mounted	81.5 lbs (37 kg)	
Height	38.1 in (97 cm)	
Width	15.7 in (40 cm)	
Depth	11 in (28 cm)	

FITTINGS		
Fitting	Air inlet (valve)	F 3/4" BSP
	Air outlet (option atomization air kit)	M1/4" NPS
	Fluid inlet	M 26 x 125
	Fluid outlet	M #5 JIC



CONFIGURATION OF THE FLOWMAX® 40.25F PUMP - STAINLESS STEEL					
Set-up	Suction rod	Drain rod	Air regulator Fluid pressure	Pump output filter	Part number
Wall mounted	●	●	●	●	151-776-200
Cart mounted	●	●	●	●	151-776-400

ATOMIZATION AIR KIT	
Description	Part number
Atomization air kit with regulator (for AIRMIX® spray guns)	151-740-200

KITS	
Description	Kit part number
Seal kit H25F	144-950-291
Repair kit H25F	144-950-292
Seal kit for 1000-4 air motor	146-270-991
Repair kit for 1000-4 air motor	146-270-995

CARTS AND RODS (SUCTION AND FLUSHING)	
Description	Kit part number
Two post cart w/o plate	051-221-000
Two post pump mounting plate	056-100-199
Easyflow suction rod, 5 gal	149-596-150
Easyflow suction rod, 55 gal	149-596-160
Stainless steel flushing rod F18 x 125	049-596-000





40.50F FLOWMAX® PUMP

New generation Flowmax® pump, ideal for feeding two guns

FEATURES	BENEFITS
Sealing done by one large stroke Bellows	High reliability No more lubricant cups Leak free Total sealing between pump and its environment, ideal to work with moisture-sensitive catalysts Ideal for UV and pre-catalyzed materials
Ergonomic design of fluid passages	Fluid discharge without retention of a wide range of coating materials
Stainless steel construction	Compatible with water-based materials
Balanced fluid section	Constant fluid output pressure
Mobile piston seal	Excellent suction capacity

SPECIFICATIONS	
Pressure ratio	40:1
Fluid volume per cycle	(100 cm ³)
Number of cycles per 33.8 oz (1 liter) of products	10
Fluid output at 30 cycles/mn	0.8 gal/mn (3 L/mn)
Air consumption at 30 cycles/mn at 85 psi (4 bar)	25.4 cfm (43.2 m ³ /h)
Free flow rate	1.6 gal/mn (6 L/mn)
Maximum fluid pressure	3480 psi (240 bar)
Maximum fluid temperature	122°F (50°C)
Maximum air inlet pressure	87 psi (6 bar)
Sound level	77 dBA
Sealing packing	Bellows: Polyethylene Upper and lower: GT (Polyethylene)
Wetted parts	Stainless steel
Weight - wall-mounted	92.5 lbs (42 kg)
Height	38.1 in (97 cm)
Width	15.7 in (40 cm)
Depth	11 in (28 cm)



FITTINGS	
Air inlet (valve)	F 3/4" BSP
Air outlet (option atomization air kit)	M 1/4" NPS
Fluid inlet	M 26x125
Fluid outlet	M #5 JIC

CONFIGURATION OF THE FLOWMAX® 40.50F PUMPS- STAINLESS STEEL

Set-up	Suction rod	Drain rod	Air regulator Fluid pressure	Pump output filter	Part number
Wall mounted	●	-	●	-	151-786-100
Wall mounted	●	●	●	●	151-786-200
Cart-mounted (on a 2-arms cart)	●	●	●	●	151-786-400

PART NUMBER

Set-up	Part number
Pump, 40-50F, w/m, c/w pump air reg, 5 gallon rod, w/o filter	668-786-103
Pump, 40-50F, w/m, c/w pump air reg, 55 gallon rod, w/o filter	668-786-104
Pump, 40-50F, w/m, c/w pump air reg, filter, 5 gallon rod	668-786-200
Pump, 40-50F, w/m, c/w pump air reg, w/o filter, suction	668-786-300
Pump, 40-50F, ww/m, c/w pump,air reg, filter, w/o suction	668-786-100
Pump, 40-50F, w/m, c/w pump,air reg, w/o filter, suction	668-786-101
Pump, 40-50F, w/m, c/w pump,air reg, filter, 55 gal rod	668-786-102

ATOMIZATION AIR KIT

Description	Part number
Atomization air kit with regulator (for AIRMIX® spray guns)	151-740-200

KITS

Description	Part number
Seal kit H 50F	144-960-291
Repair kit H 50F	144-960-292
Seal kit for 2000-4 air motor	146-270-990
Repair kit for 2000-4 air motor	146-270-996

CARTS AND RODS (SUCTION AND FLUSHING)

Description	Part number
Two post cart w/o plate	051-221-000
Two post pump mounting plate	056-100-199
Easyflow suction rod, 5 gal	149-596-150
Easyflow suction rod, 55 gal	149-596-160
Stainless steel flushing rod F18 x 125	049-596-000

AD 60/61 HEATERS

EXPLOSION PROOF



Original design ensuring optimum heat transfer with no risk of burning the paint in the heater.

By adding heat, viscosity is reduced. Lower viscosity means atomization pressures can be reduced. The result is higher transfer efficiency and a more consistent finish.

Reduces paint viscosity without dilution.

To be used in zone 1 and 2 according to ATEX.

Agreement INERIS 03ATEX 0079X

 II 2 G EEx d IIA T3



FEATURES	BENEFITS
A thermometer is integrated into the command box	No pressure loss when working with high viscosity materials
Modular design	Easy maintenance
Available in stainless steel version	Compatible with water-based materials
Fluid body and fittings	Stainless steel

SPECIFICATIONS	
Thermostat type	By fluid extension and dry contact
Thermal fuse	Cut at 249.8°F (121°C)
Thermometer	Graduation 32 - 249.8°F (0 - 100°C)
Temperature range	59 - 176°F (15 - 80°C)
Pressure	3480 psi (240 bar) maxi
Weight	Aluminum: 34.1 lbs (15.5 kg) Stainless steel: 55.1 lbs (kg)5
Wetted parts	Aluminum: aluminum body, galvanized chrome fittings Stainless steel: stainless steel body and fittings
Room temperature	104°F (40°C) maxi







* When used in accordance with the specifications stated in the operating manual. If the paint does not circulate properly or the unit malfunctions the paint could be damaged by over heating.

AD HEATERS - ALUMINUM VERSION (SOLVENT-BASED MATERIALS)

Aluminum heater	Voltage / Power		Temperature	Cable length w/o plug	Fitting		Part number
	Volt	Watt			Inlet	Outlet	
AD60 	230	1500	59 - 176°F (15 - 80°C)	32.8 feet (10 m)	#5 JIC	#5 JIC	056-126-000
AD61 	115	1500	59 - 176°F (15 - 80°C)	16.4 feet (5 m)	#5 JIC	#5 JIC	056-126-050

AD HEATERS - STAINLESS STEEL VERSIONS (SOLVENT OR WATER-BASED MATERIALS)

Stainless steel heater	Voltage / Power		Temperature	Cable length w/o plug	Fitting		Part number
	Volt	Watt			Inlet	Outlet	
AD60 	230	1500	59 - 176°F (15 - 80°C)	32.8 feet (10 m)	#5 JIC	#5 JIC	056-146-000
AD61 	115	1500	59 - 176°F (15 - 80°C)	16.4 feet (5 m)	#5 JIC	#5 JIC	056-146-050
AD60 	400	1250	59 - 176°F (15 - 80°C)	16.4 feet (5 m)	#5 JIC	#5 JIC	056-146-070
AD60 	480	1500	59 - 176°F (15 - 80°C)	16.4 feet (5 m)	#5 JIC	#5 JIC	156-145-200

ONE-PASS™ HEATER

EXPLOSION PROOF



The economical and reliable solution for a consistent spraying quality by reducing the viscosity of paints without adding solvents. The heating of the product is done in one single passage in the One-Pass™ Heater thanks to the new design and the optimized thermal exchange efficiency.

This innovative design offers the possibility to install the One-Pass™ Heater directly between the pump and the gun without recirculation. Its dimensions and reduced weight allow to fit on a mobile pump (2 arms cart and mounting plate)

To be used in zone 1 and 2 according to ATEX

Agreement ISSeP 05ATEX031



 II 2 G Ex d IIA T3



FEATURES	BENEFITS
Standard stainless steel version	Compatible with water-based materials
A thermal tape is on the body of the paint circuit	No pressure loss when working with high viscosity materials
Reduced dimensions	Cart mounting
Modular design	Quick and easy maintenance
t max: 68°F (20°C) at an output of 27.05 oz/mn (800 cc/mn)	Optimized performances in most applications
Cart mount	Easy mobility

SPECIFICATIONS	
Thermostat type	By fluid expansion and dry contact
Thermal fuse	Cut at 161.6°F (72°C)
Thermometer	Graduation 32 - 140°F (0 - 60°C)
Temperature range	68-104°F (20-40°C)
Pressure	1740 psi (120 bar)
Weight	36.4 lbs (16.5 kg)
Wetted parts	Stainless steel and PTFE
Room temperature	104°F (40° bar) maxi
Flow rate	max 27.05 oz/mn (800 cc/mn)

ONE PASS HEATER PART NUMBERS

Stainless steel One-pass heater	Voltage / Power		Temperature	Cable length w/o plug	Fitting		Part number
	Volt	Watt			Inlet	Outlet	
One-pass  115V	115	1400	68-104°F (20-40°C)	16.4 feet (5 m)	#5 JIC	#5 JIC	056-151-110
One-pass  230V	230	1400	68-104°F (20-40°C)	16.4 feet (5 m)	#5 JIC	#5 JIC	056-152-110

■ Y- fitting - stainless steel

Allowing paint circulation on the gun while maintaining ease of use. Remote set-up possible using an additional hose.

Y-FITTING PART NUMBERS

Description	Fittings on gun	Hoses thread	Part number
Stainless steel Y-fitting - for AIRMIX® guns	F #5 JIC	M #5 JIC	029-520-500



■ Circulation valve SS (for solvent-based materials)

Allows you to set the perfect output for circulation.
Max. fluid pressure: 3480 psi (240 bar).

CIRCULATION VALVES PART NUMBERS (NON STAINLESS STEELS)

Thread		Rod	Back fitting	Flushing valve	Flushing rod M 18 x 125	Part number
Pump intake						
F 26 x 125	M 26 x 125	#5 JIC	●	●	668-000-028	



■ Airmix® back pressure regulator

Assures a constant pressure in the fluid circuit.
Regulation pressure: 0-1015 psi (0 - 70 bar).

AIRMIX® BACK PRESSURE REGULATOR PART NUMBERS

Version	Thread		Back fitting	Flushing valve	Flushing rod M 18 x 125	Part number
	Pump intake	Rod				
Wall-mounted	F 26 x 125	M 26 x 125	#5 JIC	●	●	051-314-030





CTM COLOR CHANGE VALVES

Recommended for a rapid color change, without the need to manipulate any fluid. At the same time, you will reduce costs through less down time and lower solvent consumption.

The solvent valve should be facing the Fluid outlet.

- Two valves per module
- PTFE seals
- Modular design allows for expansion
- Paint circulation through the valve
- Opening index as standard



CTM VALVE SPECIFICATIONS	
Description	AIRMIX®
Max pressure	1740 - 2900 psi (120-200 bar)
Ø of passage	0.236 in (6 mm)
Trigger air	for hose 2.7 x 4
Fluid inlet	F 1/4 NPS
Fluid outlet	F 1/4 NPS

ACCESSORIES		
	Description	Part number
Airmix®	End module (inlet) - 1740 psi (120 bar)	155-535-300
	Intermediate module - 1740 psi (120 bar)	155-535-400
	End module (inlet) - 290 psi (200 bar)	155-535-350
	Intermediate module - 2900 (200 bar bar)	155-535-450
	Outlet flange	155-535-500
Assembly module rods C/w outlet module:		
	1 module (1 end + 1 flange)	155-535-610
	2 modules (1 end + 1 intermediate + 1 flange)	155-535-620
	3 modules (1 end + 2 intermediate + 1 flange)	155-535-630
	4 modules (1 end + 3 intermediate + 1 flange)	155-535-640
	5 modules (1 end + 4 intermediate + 1 flange)	155-535-650
	Assembly of 2 fixing squares	155-535-700



08.120T PUMP

For circulating and large production applications. The Turbo air motor is recommended for continuous use.

FEATURES	BENEFITS
Large diameter suction rod and high compression ratio	Can be used with a wide range of materials
Stainless steel construction	Compatible with water-based materials
Simple design, reduced number of spare parts	Easy maintenance

FEATURES		
Pressure ratio	8:1	
Fluid volume per cycle	8.12 oz/mn (240 cm ³)	
Number of cycles per 33.8 oz (1 liter) of products	4	
Fluid output at 30 cycles/mn	1.9 gal/mn (7.20 L/mn)	
Free flow rate	3.8 gal/mn (14.4 L/mn)	
Air consumption @ 30 CPM at 72.5 psi (5 bar)	12 cfm (20.4 m ³ /h)	
Maximum air inlet pressure	87 psi (6 bar)	
Maximum fluid pressure	696 psi (48 bar)	
Maximum fluid temperature	140°F (60°C)	
Sound level	76 dBA	
Sealing packings	Upper sealing	PTFE G + Polyfluid
	Lower sealing	HDPE
Weight - wall-mounted	59.5 lbs (27 kg)	
Wetted parts	Stainless steel	
Height	34 in (86.4 cm)	
Width	14 in (35.6 cm)	
Depth	10 in (25.4 cm)	



FITTINGS		
Fitting	Air inlet (valve air equipment)	F 3/4 BSP
	Fluid inlet	M 26 x 125
	Fluid output (filter)	#5 JIC

CONFIGURATION OF THE AIRMIX® 08.120T PUMP

Set-up	Suction rod	Drain rod	Air regulator fluid pressure	Pump output filter	Part number
Turbo wall mounted	-	-	●	-	151-798-100
Turbo wall mounted	●	●	●	●	151-798-200
Turbo cart mounted	●	●	●	●	151-798-400
Turbo wall mounted	-	●	●	●	668-798-100
Turbo wall mounted	● (55 gal)	●	●	●	668-798-102
Turbo wall mounted	●	-	●	-	668-798-103
Turbo wall mounted	● (55 gal)	-	●	-	668-798-104

KITS	
Description	Part number
Seal kit H120	144-970-090
Repair kit H120	144-970-095
Seal kit for 1000-4 air motor	146-270-991
Repair kit for 1000-4 air motor	146-270-995

CARTS AND RODS (SUCTION AND FLUSHING)

Description	Part number
Two post cart w/o plate	051-221-000
Two post pump mounting plate	056-100-199
Easyflow suction rod, 5 gal	149-596-150
Easyflow suction rod, 55 gal	149-596-160
Stainless steel flushing rod F18 x 125	049-596-000



08.120FT FLOWMAX® PUMP

For circulating and large production applications. The Turbo air motor is recommended for continuous use.

FEATURES	BENEFITS
Sealing done by one large stroke Bellows	High reliability No more lubricant cups Leak free Total sealing between pump and its environment, ideal to work with moisture-sensitive catalysts Ideal for UV and pre-catalyzed materials
Ergonomic design of fluid passages	Fluid discharge without retention of a wide range of coating materials
Stainless steel construction	Compatible with water-based materials
Balanced fluid section	Constant fluid output pressure
Mobile piston seal	Excellent suction capacity



FEATURES		
Pressure ratio	8:1	
Fluid volume per cycle	8.12 oz/mn (240 cm ³)	
Number of cycles per 33.8 oz (1 liter) of products	4	
Fluid output at 30 cycles/mn	1.9 gal/mn (7.20 L/mn)	
Free flow rate	3.8 gal/mn (14.4 L/mn)	
Air Consumption @ 20 CPM at 72 psi (5 bar)	12 cfm (20.4 m ³ /h)	
Maximum air inlet pressure	87 psi (6 bar)	
Maximum fluid pressure	696 psi (48 bar)	
Maximum fluid temperature	131°F (50°C)	
Sound level	76 dBA	
Sealing packing	Bellows	Polyethylene
	Upper and lower	GT Polyethylene
Weight - wall-mounted	70.5 lbs (32 kg)	
Wetted parts	Stainless steel	
Height	41.3 in (105 cm)	
Width	15.7 in (40 cm)	
Depth	10.6 in (27 cm)	

FITTINGS	
Air inlet (valve air equipment)	F 3/4 BSP
Fluid inlet	M 26 x 125
Fluid output (filter)	#5 JIC

CONFIGURATION OF THE FLOWMAX® AIRMIX® 08.120F PUMP - STAINLESS STEEL

Set-up	Suction rod	Drain rod	Atomization air regulator	Air regulator Fluid pressure	Pump output filter	Part number
Turbo wall-mounted	-	-	●	●	-	151-799-100
Turbo wall-mounted	●	●	●	●	●	151-799-200

NUMBER

Pump output filter	Part number
Pump, 08-120FT, w/m, c/w pump air reg, filter, w/o suction	668-799-100
Pump, 08-120FT, w/m, c/w pump air reg, filter, 55 gallon rod	668-799-102
Pump, 08-120FT, w/m, c/w pump air reg, 5 gallon rod, w/o filter	668-799-103
Pump, 08-120FT, w/m, c/w pump air reg, 55 gallon rod, w/o filter	668-799-104
Pump, 08-120FT, c/w pump air reg filter, abrasive kit, w/o suction	668-799-116
Pump, 08-120FT, c/w pump air reg abrasive kit, w/o suction/filter	668-799-118

Description	Part number
Seal kit H120F	144-970-490
Repair kit H120F	144-970-495
Seal kit for 1000-4 air motor	146-270-991
Repair kit for 1000-4 air motor	146-270-995

CARTS AND RODS (SUCTION AND FLUSHING)

Description	Part number
Two post cart w/o plate	051-221-000
Two post pump mounting plate	056-100-199
Easyflow suction rod, 5 gal	149-596-150
Easyflow suction rod, 55 gal	149-596-160
Stainless steel flushing rod F18 x 125	049-596-000



16.120T PUMP

For circulating and large production applications. The Turbo air motor is recommended for continuous use.

FEATURES	BENEFITS
Large diameter suction rod and high compression ratio	Can be used with a wide range of materials
Stainless steel construction	Compatible with water-based materials
Simple design, reduced number of spare parts	Easy maintenance

SPECIFICATIONS		
Pressure ratio	16/1	
Fluid volume per cycle	8.12 oz/mn (240 cm ³)	
Number of cycles per 33.8 oz (1 liter) of products	4	
Fluid output at 30 cycles/mn	1.9 gal/mn (7.20 L/mn)	
Free flow rate	3.8 gal/mn (14.4 L/mn)	
Air consumption @ 30 CPM at 72 psi (5 bar)	24.4 cfm (41.5 m ³ /h)	
Maximum air inlet pressure	87 psi (6 bar)	
Maximum fluid pressure	1392 psi (96 bar)	
Maximum fluid temperature	140°F (60°C)	
Sound level	76 dBA	
Sealing packings	Upper sealing	PTFE G + Polyfluid
	Lower sealing	HDPE
Weight - wall-mounted	59.5 lbs (27kg)	
Wetted parts	Stainless steel	
Height	34 in (86.4 cm)	
Width	14 in (35.6 cm)	
Depth	10 in (25.4 cm)	

FITTINGS		
Fitting	Air inlet (valve air equipment)	F 3/4 BSP
	Fluid inlet	M 26 x 125
	Fluid output (filter)	#5 JIC



CONFIGURATION OF THE AIRMIX® 16.120T PUMP					
Set-up	Suction rod	Drain rod	Air regulator fluid pressure	Pump output filter	Part number
Turbo wall-mounted	-	-	●	-	151-797-100
Turbo Wall mounted	●	●	●	●	151-797-200
Turbo wall mounted	-	●	●	●	668-797-100
Turbo wall mounted	● (55 gal)	●	●	●	668-797-102
Turbo wall mounted	●	-	●	-	668-797-103
Turbo wall mounted	● (55 gal)	-	●	-	668-797-104

KITS	
Description	Part number
Seal kit H120	144-970-090
Repair kit H120	144-970-095
Seal kit for 2000-4 air motor	146-270-990
Repair kit for 2000-4 air motor	146-270-996

CARTS AND RODS (SUCTION AND DRAIN)	
Description	Part number
Two post cart w/o plate	051-221-000
Two post pump mounting plate	056-100-199
Easyflow suction rod, 5 gal	149-596-150
Easyflow suction rod, 55 gal	149-596-160
Stainless steel flushing rod F18 x 125	049-596-000



16.120FT FLOWMAX® PUMP

For circulating and large production applications. The Turbo air motor is recommended for continuous use.

FEATURES	BENEFITS
Sealing done by one large stroke Bellows	High reliability No more lubricant cups Leak free Total sealing between pump and its environment, ideal for work with moisture-sensitive catalysts Ideal for UV and pre-catalyzed materials
Ergonomic design of fluid passages	Fluid discharge without retention of a wide range of coating materials
Stainless steel construction	Compatible with water-based materials
Balanced fluid section	Constant fluid output pressure
Mobile piston seal	Excellent suction capacity

SPECIFICATIONS	
Pressure ratio	16:1
Fluid volume per cycle	8.12 oz/mn (240 cm ³)
Number of cycles per 33.8 oz (1 liter) of products	4
Fluid output at 30 cycles/mn	1.9 gal/mn (7.2 L/mn)
Free flow rate	3.8 gal/mn (14.4 L/mn)
Air Consumption @ 20 CPM at 72 psi (5 bar)	24.1 cfm (41.5 m ³ /h)
Maximum air inlet pressure	87 psi (6 bar)
Maximum fluid pressure	1392 psi (96 bar)
Maximum fluid temperature	131°F (50°C)
Sound level	76 dBA
Sealing packing	Bellows: Polyethylene Upper and lower: GT polyethylene
Weight	70.5 lbs (32 kg)
Wetted parts	Stainless steel
Height	41.3 in (105 cm)
Width	15.7 in (40 cm)
Depth	10.6 in (27 cm)

FITTINGS		
Fitting	Air inlet (air equipment)	F 3/4 BSP
	Fluid inlet	M 26 x 125
	Fluid output (filter)	#5 JIC



CONFIGURATION OF THE FLOWMAX® AIRMIX® 16.120FT PUMP - STAINLESS STEEL

Set-up	Suction rod	Drain rod	Air regulator Fluid pressure	Pump output filter	Part number
Turbo wall-mounted	-	-	●	-	151-796-100
Turbo wall-mounted	●	●	●	●	151-796-200
Turbo Cart-mounted	●	●	●	●	151-796-400
Turbo wall mounted	-	●	●	●	668-796-100
Turbo wall mounted	● (55 gal)	●	●	●	668-796-102
Turbo wall mounted	●	-	●	-	668-796-103
Turbo wall mounted	● (55 gal)	-	●	-	668-796-104

KITS	
Description	Part number
Seal kit H120F	144-970-490
Repair kit H120F	144-970-495
Seal kit for 2000-4 air motor	146-270-990
Repair kit for 2000-4 air motor	146-270-996

CARTS AND RODS (SUCTION AND FLUSHING)

Description	Part number
Two post cart w/o plate	051-221-000
Two post pump mounting plate	056-100-199
Easyflow suction rod, 5 gal	149-596-150
Easyflow suction rod, 55 gal	149-596-160
Stainless steel flushing rod F18 x 125	049-596-000



08.220FT FLOWMAX® PUMP

High output ,cartridge free Bellows pump for circulating and automatic machines.

FEATURES	BENEFITS
Sealing done by one large stroke Bellows	High reliability No more lubricant cups Leak free Total sealing between pump and its environment, ideal to work with moisture-sensitive catalysts Ideal for UV and pre-catalyzed materials
Ergonomic design of fluid passages	Fluid discharge without retention of a wide range of coating materials
Stainless steel construction	Compatible with water-based materials
Balanced fluid section	Constant fluid output pressure
Mobile piston seal	Excellent suction capacity

SPECIFICATIONS		
Pressure ratio	8: 1	
Fluid volume per cycle	14.8 oz/mn (440 cm ³)	
Number of cycles per 33.8 oz (1 liter) of products	2.3	
Fluid output at 20 Cycles/mn	2.3 gal/mn (8.8 L/mn)	
Free flow rate	6.9 gal.mn (26.4 L/mn)	
Air Consumption @ 20 CPM at 72 psi (5 bar)	14.9 cfm (25.3 m ³ /h)	
Maximum fluid pressure	696 psi (48 bar)	
Maximum fluid temperature	131°F (50°C)	
Maximum air inlet pressure	87 psi (6 bar)	
Sound level	76 dBA	
Sealing packing	Bellows	Polyethylene
	Upper and lower	GT ployethylene
Wetted parts	Stainless steel, hard-chrome stainless steel, carbide	
Weight	119 lbs (54 kg)	
Height	43 in (110 cm)	
Width	15.7 in (40 cm)	
Depth	10.7 in (27)	

FITTINGS		
Fitting	Air Inlet	F 3/4" BSP
	Fluid inlet	F 3/4" BSP
	Fluid outlet	F 3/4" BSP

CONFIGURATION OF THE 08.220FT PUMP - STAINLESS STEEL					
Set-up	Suction rod	Drain rod	Air regulator Fluid pressure	Pump output filter	Part number
Wall mounted	-	-	●	-	151-861-200
Wall mounted	-	-	●	●	668-861-100
Wall mounted	● (55 gal)	-	●	●	668-861-102
Wall mounted	● (55 gal)	-	●	-	668-861-104

CART, FILTER AND ROD (SUCTION AND FLUSHING)	
Description	Part number
Two reinforced arms w/o mounting plate	051-231-000
Pump bracket	051-341-206
Suction rod Ø25 plunging tube length 23.6 in (600 mm)	049-597-100
Stainless steel Accumulator equipped filter 3/4"	155-581-400
Stainless steel flushing rod F18 x 125	049-596-000





20.220FT FLOWMAX® PUMP

High output, cartridge free Bellows pump for circulating and automatic machines.

FEATURES	BENEFITS
Sealing done by one large stroke Bellows	High reliability No more lubricant cups Leak free Total sealing between pump and its environment, ideal to work with moisture-sensitive catalysts Ideal for UV and pre-catalyzed materials
Ergonomic design of fluid passages	Fluid discharge without retention of a wide range of coating materials
Stainless steel construction	Compatible with water-based materials
Balanced fluid section	Constant fluid output pressure
Mobile piston seal	Excellent suction capacity

SPECIFICATIONS		
Pressure ratio	20:1	
Fluid volume per cycle	14.8 oz/mn (440 cm³)	
Number of cycles per 33.8 oz (1 liter) of products	2.3	
Fluid output at 30 cycles/mn	2.3 gal/mn (8.8 L/mn)	
Free flow rate	6.9 gal/mn (26.4 L/mn)	
Air Consumption @ 20 CPM at 72 psi (5 bar)	37.3 cfm (63.4 m³/h)	
Maximum air inlet pressure	116 psi (6 bar)	
Maximum fluid pressure	1740 psi (120 bar)	
Maximum fluid temperature	131°F (50°C)	
Sound level	< 82 dBA	
Sealing packing	Bellows	Polyethylene
	Upper and lower	GT polyethylene
Weight	145 lbs (66 kg)	
Wetted parts	Stainless steel, carbide, hard chrome stainless steel	
Height	43.9 in (111.5 cm)	
Width	25.2 in (64 cm)	
Depth	12.8 in (35 cm)	

FITTINGS		
Fitting	Air inlet (valve)	F 3/4" BSP
	Fluid inlet	F 1" BSP
	Fluid outlet	F 3/4 NPS



DURATION OF THE 20.220FT PUMP - STAINLESS STEEL

Set-up	Suction rod	Drain rod	Air regulator Fluid pressure	Filter	Part number
Wall-mounted	-	-	●	-	151-860-200
Wall-mounted	-	-	●	●	668-860-100
Wall-mounted	● (55 gal)	-	●	●	668-860-102
Wall-mounted	● (55 gal)	-	●	-	668-860-104

FILTER AND RODS (SUCTION AND FLUSHING)

Description	Part number
Two reinforced arms w/o mounting plate	051-231-000
Pump bracket	051-341-206
Stainless steel Accumulator equipped filter 3/4"	155-581-400
Suction rod Ø25 plunging tube length 23.6 in (600 mm)	049-597-100
Stainless steel flushing rod F18 x 125	049-596-000

■ Pressure regulator - manual control - AIRMIX®

AIRMIX® fluid regulator is designed for low to medium viscosity materials

CHARACTERISTICS		
Pressure range (bar)	Inlet	3625 psi (250 bar) max
	Outlet (upon version)	145 - 1015; 145 - 1740 psi (10 - 70; 10-120 bar)
Weight	7.9 lbs (3.6 kg)	
Width	3.5 in (8.9 cm)	
Height	7.8 in (20 cm)	
Wetted parts	Stainless steel, PTFE, carbide	

FITTINGS		
Fitting	Fluid inlet	F 3/8" NPS
	Fluid outlet	F 3/8" NPS

CONFIGURATION	
Description	Part number
Manual regulator 250 - 145 - 1015 psi (10 - 70 bar)	155-271-730
Manual regulator 250 - 145 - 1740 psi (10 - 120 bar)	155-271-735
Manual regulator PH 250 - 145 - 1740 psi (10 - 120 bar)	155-271-770
Wall bracket	155-484-010
Kit, gauge S/S 1000 psi (70 bar)	668-271-790
Kit, gauge S/S 2000 psi (120 bar)	668-271-795



■ Pressure regulator - Piloted - AIRMIX®

AIRMIX® fluid regulator is designed for low viscosity materials. The piloted version features an increased regulation accuracy and a remote control.

SPECIFICATIONS	
Pressure range (bar)	Inlet (upon version): 120 max 72-580 psi (5-40 bar) or 250 max 150-1015 psi (10-70 bar) and 150-1740 psi (10-120 bar) Outlet (upon version): 72*580 psi (05-40 bar); 150-1015 psi (10-70 bar); 150-1740 psi (10-120 bar)
Weight - max: 145 - 1740 psi (10 - 120 bar)	9 lbs (4.1 kg)
Width - w/o pilot	3.5 in (8.9 cm)
Height - (max: 145 - 1740 psi (10 - 120 bar) version)	10.8 in (27.5 cm)
Wetted parts	Stainless steel, PTFE, carbide

FITTINGS		
Fitting	Fluid inlet	F 3/8" NPS
	Fluid outlet	F 3/8" NPS
	Air inlet (pilotage)	F 1/4" BSP

CONFIGURATION OF PILOTED REGULATOR WITH/WITHOUT PILOT	
Description	Part number
Piloted regulator without pilot 250 - 145 - 1015 psi (10 - 70 bar)	155-271-740
Piloted regulator without pilot 250 - 145 - 1740 psi (10 - 120 bar)	155-271-745
Piloted regulator with pilot 250 - 145 - 1015 psi (10 - 70 bar)	155-271-750
Piloted regulator with pilot 250 - 145 - 1740 psi (10 - 120 bar)	155-271-755
Piloted regulator without pilot 120 - 72 - 580 psi (5 - 40 bar)	155-271-760
Piloted regulator with pilot 120 - 72 - 580 psi (5 - 40 bar)	155-271-765

CONFIGURATION OF CARTRIDGE PILOTED REGULATORS WITHOUT PILOT	
Description	Part number
Cartridge piloted regulator 250 - 145 - 1015 psi (10 - 70 bar)	155-271-715
Cartridge piloted regulator 250 - 145 - 2320 psi (10 - 160 bar)	155-271-716
Cartridge piloted regulator 120 - 72 - 580 psi (5 - 40 bar)	155-271-719



■ Pressure regulator - Piloted - AIRMIX®

ACCESSORIES

Description	Part number
Wall bracket	155-484-010

■ Back pressure regulator - AIRMIX®

SPECIFICATIONS

Pressure range	Inlet	1740 psi (120 bar) max
	Regulated outlet	145 - 1740 psi (10 - 120 bar)
Weight		7.9 lbs (3.6 kg)
Width		3.5 in (8.9 cm)
Height		7.8 in (20 cm)
Wetted parts		Stainless steel, PTFE, carbide

FITTINGS

Fitting	Fluid inlet	F 3/8" NPS
	Fluid outlet	F 3/8" NPS

CONFIGURATION

Set-up	Fitting (suction)	Part number
Manual regulator 120 - 145 - 1740 psi (10 - 120 bar)	-	155-271-835
Manual regulator 120 - 145 - 1740 psi (10 - 120 bar) Equipped for wall-mounting, supplied with 2m fluid hose and fittings for pump suction	26 x 125	051-314-030
Wall bracket		155-484-010



■ High pressure gauges

Metal pressure gauge with glass and glycerin lens; totally impact and solvent resistant.

HIGH PRESSURE GAUGES

Description	Pressure range	Fitting	Internal diameter	Part number
Diaphragm high pressure gauge	0-3625 psi (0 - 250 bar)	M 3/8" NPS - F 3/8" NPS	1.9 in (50 mm)	155-271-790
Pressure gauge bottom inlet	0-1000 psi (0 - 69 bar)	M 1/4 NPT	2.5 in	055-729-514
Pressure gauge bottom inlet	0 - 5800 psi (0 - 400 bar)	M 1/4 NPT	2.5 in	055-729-512



Filter 3480 PSI (240 BAR)

EQUIPPED FILTER						
Description	Maximum fluid pressure	Stainless steel screen for filter	Thread		Drain	Part number
			Inlet	Outlet		
Stainless steel Accumulator filter 3/8"	3480 psi (240 bar)	6	F 3/8" NPT	#5 JIC	M 18x125	155-580-300
Stainless steel Accumulator filter 3/8"		12	F 3/8" NPT	#5 JIC	M 18x125	155-580-400
Stainless steel Accumulator filter 3/8" for EOS		6	F 3/8" NPT	#5 JIC	M 18x125	155-580-600
Stainless steel Accumulator filter 3/4"		12	F 3/4" NPT	#12 JIC	M 18x125	155-581-400

ACCESSORIES FOR FILTERS	
Description	Part number
Stainless steel filter fitting length 2.7 in (70 mm) MM 3/8" NPT	055-580-301
Stainless steel filter fitting length 2.7 in (70 mm) MM 3/4" NPT	055-581-401
Wall-mounted bracket and screws for 3/8", 3/4" and 1" filter with 9 digits part numbers	155-190-105

Inline fluid filters 2900 PSI (200 BAR)

Fluid filtration is of the utmost importance in the prevention of spray gun wear; it also avoids all unnecessary line down time due to blockages.

FILTER CONFIGURATION						
Description	Maximum fluid pressure	Stainless steel screen for filter	Average output	Thread		Part number
				Inlet	Outlet	
(1) Medium pressure stainless steel filter	2900 psi (200 bar)	6	1.6 Gal/mn (2 L/mn)	F 1/4 NPS	F 1/4 NPS	055-600-000

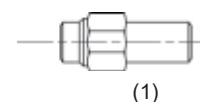

Strainers for suction rods

STRAINERS CONFIGURATION						
Pump	Height	External diameter	Material	Filtration size		Part number
				Micron	Mesh	
10.14	2.3 in (60 mm)	1.6 in (40 mm)	Polyamide	300	50	051-531-600
EOS 15-C25 / EOS 30-C25 (5/8" Ø16)	1.3 in (32.5 mm)	1.1 in (28 mm)	Stainless steel	1000	15	149-596-052
EOS 30-C25, 10.25 / 17.A2 / 20.25 / 20.25F / 34.A2 / 40.25 / 40.25F / 08.120 / 08.120F / 16.120 / 16.120F (Ø25)	1.6 in (40 mm)	1.9 in (48 mm)	Stainless steel	1000	15	149-596-152
40.25 / 40.50WB	1.6 in (40 mm)	1.9 in (48 mm)	Stainless steel	1000	15	921-270-102
40.130-2 / 40.130 F2 / 65.130 / 65.130 F2	4.4 in (112 mm)	2.6 in (66 mm)	Polyamide	1000	15	149-591-400



Screens and cartridges for product filter

SCREEN CONFIGURATION (FILTRATION SURFACE 65 CM2)				
Filter number	Filtration size		Nozzle size	Part number
	Micron	Mesh		
1	40	325	3	000-161-101
2	74	200	4	000-161-102
3	90	170	4	000-161-103
4	100	140	4	000-161-104
6	168	85	6	000-161-106
8	210	70	09 & 14	000-161-108
12	280	55	20	000-161-112
15	360	45	30 & 45	000-161-115
20	510	30	≥ 68	000-161-020
30	750	20	≥ 68	000-161-030

NOTES

A series of horizontal dotted lines for writing notes.



■ Fluid hoses for AIRMIX® spraying

- The hoses should be chosen according to the pressure used in the application and electrical conductivity



HOSES CONFIGURATION						
Description	Part number					
Conductive	NO			YES		
Color	GREY			BLUE		
Internal diameter mm	3.2 (1/8")	4.8 (3/16")	6.35 (1/4")	3.2 (1/8")	4.8 (3/16")	6.35 (1/4")
Max. operating pressure	1740 psi (120 bar)			3480 psi (240 bar)		
Temperature	up to 212°F (100°C)					
25 m	050-450-059	050-450-060	050-450-070	-	-	-
100 m		050-450-061	050-450-071	-	-	-
300 m		050-450-064	050-450-072	-	-	-
Fitting alone to crimp		905-063-304	905-063-305	-	-	-
Fitting alone to screw in	-	905-063-308	905-063-309	-	-	-
Fitting alone stainless steel to crimp	905-063-359	905-063-354	905-063-355	-	-	-
Fitting alone stainless steel to screw in	905-063-356	905-063-358	905-063-357	-	-	-
Spring for fitting to crimp		905-063-361		-	-	-
PART NUMBER ACCORDING TO LENGTH WITH FITTINGS per meter						
A and B fittings (swivel)	#5 JIC					
Treated Stainless Steel Fittings						
		With spring	Without spring	Without spring	With spring	Without spring
15.7 in (0.4 m)						050-450-101
1' 11" (0.6 m)		050-450-805	050-450-701			050-450-106
2' 7" (0.8 m)			050-450-702			050-450-107
3' 3" (1 m)	-	050-450-809	050-450-703		050-450-601	050-450-102
6' 7" (2 m)		050-450-806	050-450-704		050-450-602	050-450-109
9' 10" (3 m)		050-450-810	050-450-705		050-450-603	050-450-110
16' 5" (5 m)		050-450-801	050-450-706		050-450-604	050-450-108
24' 7" (7.5 m)		050-450-808			050-450-605	050-450-111
32' 9" (10 m)		050-450-802	050-450-707		050-450-606	050-450-104
49' 2" (15 m)		050-450-811	050-450-709		050-450-607	050-450-112
65' 7" (20 m)		050-450-812	050-450-708		050-450-608	050-450-105
82' (25 m)						050-450-113
98' 5" (30 m)					050-450-609	
Stainless Steel Fittings						
1' 11" (0.6 m)		050-450-851			050-450-651	
3' 3" (1 m)				050-451.151		
16' 5" (5 m)		050-450-852		050-451.152	050-450-652	050-450-152
24' 7" (7.5 m)		050-450-853		050-451.153	050-450-653	050-450-153
32' 9" (10 m)				050-451.154		050-450-154

■ Product hoses for suction rod

HOSE FOR SUCTION ROD			
Description	Part number		
Polyethylene hose sleeve	Ø 9.5 mm	Ø 19 mm	Ø 25 mm
16' 5" (5 m) cut	050-361-005	050-366-051	050-367-001
49' 2" (15 m) cut	050-361-004	050-366-052	-
82' (25 m) cut	050-361-001	050-366-053	050-367-003
Grooved conical fitting	050-140-517	050-140-545	050-140-543
Nickeled nut fitting	050-271-303	050-271-502	049-595-306
1 wing collar	906-311-234	906-311-207	906-311-204

■ Nitrile air hoses

To use so that the equipment (gun and pump) have the same potential

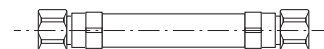

HOSES CONFIGURATION				
Description	Part number			
Material	Nitrile	Nitrile	Nitrile	Nitrile
Color	Black	Black	Black	Black
Internal diameter	0.275 in (7 mm)	0.315 in (8 mm)	0.393 in (10 mm)	0.629 in (16 mm)
Conductor	yes	yes	yes	yes
Color	Gold	Green	White	Blue
Maximum pressure	145 psi (10 bar)			
P.N. by 16' 5" (5 m) without fitting	050-382-005	050-389-004	050-381-005	050-383-005
P.N. by 49' 2" (15 m) without fitting	050-382-004	050-389-003	050-381-004	050-383-004
P.N. by 82' (25 m) without fitting	050-382-001	050-389-001	050-381-001	050-383-001
P.N. by 328' 1" (100 m) without fitting	050-382-002	050-389-002	050-381-002	-
Collar SK	906-311-224	906-311-224	906-311-226	906-311-232
Part number according to length with fittings				
Fitting A and B	1/4" NPS		3/8" NPS	26 x 125
9" (0.25 m)	-	-	-	050-383-107
1' 1" (0.35 m)	050-382-101	-	-	-
1' 6" (0.45 m)	-	-	-	050-383-109
2' 4" (0.70 m)	050-382-104	050-389-104	-	050-383-104
2' 6" (0.75 m)	-	-	-	050-383-110
6' 7" (2 m)	050-382-111	-	-	-
16' 5" (5 m)	050-382-109	050-389-101	050-381-101	-
24' 7" (7.5 m)	050-382-114	050-389-103	-	-
32' 9" (10 m)	050-382-110	050-389-102	050-381-102	-
49' 2" (15 m)	050-382-116	050-389-105	-	-
65' 7" (20 m)	050-382-113	-	-	-
82' (25 m)	050-382-217	-	-	-

■ Polyamide or Polyurethane air hoses

HOSES CONFIGURATION								
Description	Part number							
Material	Polyamide				Polyurethane			
Color	translucent			black		blue		black
Internal diameter	(2.7 x 4 mm)	(4 x 6 mm)	(6 x 8 mm)	(6 x 8 mm)	(8 x 10 mm)	(4 x 6 mm)	(6 x 8 mm)	(8 x 12 mm)
Conductive	non							
Maximum operating pressure	145 psi (10 bar)							
Temperature	up to 140°F (60°C)							
P.N. without fittings								
82' (25 m) cut	-	050-371-001	050-371-002	-	-	-	-	-

■ Hose sleeve

PART NUMBERS			
Description	Product hole	Length	Part number
Hoses sleeve	1.5 in (40 mm)	32' 8" (10m)	129-270-087

■ Lubricants and greases for pumps

LUBRICANT FOR PUMP FITTINGS

Description	Part number
Lubricants for pump fittings	
Lubricant T 8.4 oz (1/4 L) can for solvent-based paints	149-990-020
Lubricant T 1 gal	668-990-001
Lubricant T 1 qt	668-990-002
Lubricant P 1 gal	668-990-021
Lubricant P 1 qt	668-990-022
Grease	
Vaseline 2.2 lbs (1 kg) "special PMP"	560-440-002
Box of 15.8 oz (450 g) PTFE grease	560-440-001
Techni Lub tube	560-440-101
Box of grease 15.8 oz (450 g)	560-420-005



■ Ergo hose kit

ERGO HOSE KIT

Description	Part number
Ergo hose kit , Airmix® gun 16 ft	668-000-576
Ergo hose kit , Airmix® gun 25 ft	668-000-161
Ergo hose kit , Airmix® gun 32 ft	668-000-577
Ergo hose kit , Airmix® gun 50 ft	668-000-163



■ Miscellaneous

PART NUMBERS

Description	Part number
M22/Xcite™ gun wrench	049-030-042
Large size brush	906-300-101
Small size brush	906-300-102
Wrench for product filters	049-030-018
Large blow gun	129-371-000
Viscosity cup N° 4 CA4	049-221-400
Thickness gauge from 25 to 2000µ	000-790-020



■ Gun cleaning kit

PART NUMBERS

Description	Part number
Gun cleaning kit	668-000-395

1/4 in (6.4 mm) nylon brush
 Gun lubricant
 Tip cleaning needles
 Cleaning needle pin vise
 Contains all necessary items for spray gun maintenance



AIRLESS EQUIPMENT

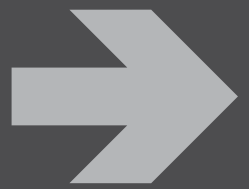

NOTES

A series of horizontal dotted lines for taking notes.



AIRLESS ASI 24 AND 40

Developed for high output production environments, ASI guns provide fine atomization at medium to high delivery rates

FEATURES	BENEFITS
Equipped with 2 fluid inlets	Allows for circulation and saves money by eliminating the need for a 2-way valve on color or flushing
No spring in the fluid passages	Saves time and money by making it easier to clean, faster color changes and less maintenance
Large choice of tips	To fit each customer need

SPECIFICATIONS	
Trigger air pressure (mini)	58 psi (4 bar) (ASI 24) 79.8 psi (5.5 bar) (ASI 40)
Maximum fluid pressure	3480 psi (240 bar) (ASI 24) 5800 psi (400 bar) (ASI 40)
Fluid output	Upon tips
Weight (gun only)	24.6 oz (700 g)
Maximum fluid temperature	122°F (50°C)
Body of the gun	Stainless steel
Wetted parts	Stainless steel, treated stainless steel, PTFE
Seat	Carbide



FITTINGS		
		Fitting
Fluid ASI 24 and ASI 40	F 1/4" NPS	Elbow M 1/4" NPT - #5 JIC
Control air	F 1/8" BSP	Elbow - M 1/8" BSP - Hose 4 x 6

PART NUMBERS		
Description		Part number
AIRLESS® ASI 24 w/o tip		129-980-000
AIRLESS® ASI 40 w/o tip		129-980-500
AIRLESS tips		See table page 153
Mounting bracket 5/8" Ø16		049-351-000

REPAIR KIT	
Description	Part number
Repair kit	129-980-901



AIRLESS ASI 40 GT

High reliability AIRLESS gun for high productivity:
 KREMLIN unique design for very abrasive UV and high solids materials.

- AIRLESS spraying for reduced overspray
- High power spring prevents any needle blockage

FEATURES	BENEFITS
Fitted with a GT cartridge	Strong resistance to very abrasive UV and high solids materials for an improved reliability
Small ball needle	For an improved laminar fluid passage
Simple and unique design (separated small ball needle and cartridge)	Very easy to service
Large choice of tips	Recommended for large fluid outputs and very high viscosity material applications
5800 psi (400 bar) spring	Strong power reducing any needle blockage



SPECIFICATIONS	
Trigger air pressure (mini)	80 psi (5.5 bar)
Maximum fluid pressure	5800 psi (400 bar)
Fluid output	Upon Tip
Weight (gun only)	24.6 oz (700 g)
Maximum fluid temperature	122°F (50°C)
Body of the gun	Stainless steel
Wetted parts	Stainless steel, treated stainless steel, PTFE
Seat	Carbide

FITTINGS		
	Gun	Fittings
Fluid ASI 24 and ASI 40	F 1/4" NPS	Elbow - M 1/4" NPT - #5 JIC
Control air	F 1/8" BSP	Elbow - M 1/8" BSP - Hose 4 x 6

PART NUMBERS		
Description		Part number
AIRLESS ASI 40 GT Gun		129-980-600
AIRLESS tips		See table page 153
Mounting bracket 5/8" Ø16		049-351-000

REPAIR KIT		
Description		Part number
Repair kit		129-980-901





AIRLESS AS2

Very compact gun with option for circulation

FEATURES	BENEFITS
Miniature size	Great for small systems with size restrictions
Wide range of AIRLESS tips	Provides many patterns choices
Lightweight design	Makes it possible to mount more guns on a reciprocator without exceeding the weight limit

SPECIFICATIONS	
Maximum fluid pressure	1740 psi (120 bar)
Fluid flow rate	upon Tips
Weight (gun only)	8.8 oz (250 g)
Maximum fluid temperature	122°F (50°C)
Body of the gun	Aluminium
Wetted parts	Stainless steel
Seat	Carbide

FITTINGS		
	Gun	Fitting
Fluid	F 1/8" NPS	M 1/8" NPT - #5 JIC
Control air	F M5	M M5 - Hose 4 x 6



CONFIGURATION OF THE AS2 AIRLESS GUN		
Description	Part number	
AIRLESS® AS 2 w/o tip	135-972-001	
AIRLESS® tips	See table page 153	
Mounting bracket 1/2" Ø12 - length 2.7 in (70 mm)	049-351-600	

■ Diaphragms for AIRLESS ASI 24 and 40

Diaphragm has to be chosen depending on nozzle diameter. it increases atomization quality.

PART NUMBERS		
Description	Nozzle	Part number
Diaphragm 12	03 - 06	000-029-112
Diaphragm 15	09 - 12	000-029-115
Diaphragm 18	14 - 18	000-029-118
Diaphragm 20	20	000-029-120
Diaphragm 25	30	000-029-125
Diaphragm 60 - standard mounting	-	000-029-160
Retaining ring MD240/MD400		000-152-290

■ Flat tips

Flat tips ensure high precision and performance; The choice of the tip must be done according to the desired flow rate in order to achieve a good finish and reduce paint costs. An AIRLESS tip needs to be replaced frequently in order to maintain the original transfer efficiency.



Part number: 000-00 XX.XX (replace of the X by the number read on the table)

FLAT TIPS																			
Size	Equivalent diameter	Fluid output at 2030 psi oz/mn (140 bar) (L/mn)	Tip Diaphragm	Handle filter (MESH)	Angle	Width of fan at 9.8 in (25 cm)													
						18°	30°	40°	50°	60°	67°	75°	82°	88°	94°				
03	0.007 in (0.18 mm)	7.78 (0.23)	09	red (200)		03-03	03-05	03-07											
04	0.009 in (0.23 mm)	10.48 (0.31)	09	red (200)			04-05	04-07	04-09	04-11									
06	0.011 in (0.28 mm)	15.55 (0.46)	12	blue (150)			06-05	06-07	06-09	06-11	06-13	06-15							
09	0.013 in (0.33 mm)	21.30 (0.63)	15	blue (150)			09-05	09-07	09-09	09-11	09-13	09-15							
12	0.015 in (0.38 mm)	29.08 (0.86)	15	blue (150)	Number engraved on the tip					12-11			12-17	12-19					
14	0.016 in (0.41 mm)	34.15 (1.01)	18	blue (150)		14-03	14-05	14-07	14-09	14-11	14-13	14-15	14-17						
18	0.018 in (0.46 mm)	45.31 (1.34)	18	yellow (100)									18-17	18-19					
20	0.020 in (0.51 mm)	50.72 (1.50)	20	yellow (100)			20-05	20-07	20-09	20-11	20-13	20-15	20-17	20-19					
30	0.024 in (0.61 mm)	70.08 (2.25)	25	yellow (100)				30-07	30-09	30-11	30-13	30-15	30-17	30-19					
45	0.029 in (0.74 mm)	112.9 (3.34)	33	white (50)				45-07		45-11	45-13	45-15			45-21				

■ Conical tips

Conical tips for direct mounting an manual and automatic guns

CONICAL TIPS																			
Equivalent diameter	Fluid output at 2030 psi oz/mn (140 bar) (L/mn)	Handle filter (MESH)	Angle	21°				28°				36°				60°			
				0.028 in (0.71 mm)	30.43 (0.9)	yellow (100)	TC2	500-002											
0.028 in (0.71 mm)	47.34 (1.4)	yellow (100)	TC3					500-003											
0.42 in (1.06 mm)	60.87 (1.8)	white (50)	TC4									500-004							
0.6 in (1.52 mm)	142 (4.2)	white (50)	TC9									500-009							

EOS 30-C25 AIRLESS PUMP STAINLESS STEEL



True accelerator of performance for your AIRLESS gun, the new paint pump Kremlin Rexion EOS range brings together Efficiency, Optimization and Simplicity.

The innovative design and component quality bring reliability and performance and allow very simple maintenance, easy cleaning and safe color changes while using a minimum of solvents. The cost of ownership is reduced at a minimum.

The new air motor design allows for a smooth start-up under low pressure air and perfectly controlled fluid output, without any pulsation at the gun with very low air consumption.

Last generation paints developed for industrial markets are handle by EOS pump stainless steel construction without any problem.

EOS pump range are available in wall-mounted versions with air control panel. A large choice of accessories (cart, tripod, product filter, suction rods) are available to at any customer need.



FEATURES	BENEFITS
Efficiency: Closed lubricating cup	Lubricant protection against external contamination Full operator safety
Efficiency: Stainless steel construction	Compatible with water-based & solvent materials
Efficiency: Balanced stroke fluid section	Steady output without any pulsation
Efficiency: Large suction valve	Recommended for materials up to 5,000 cps
Optimization: Compact design	Fits in small working areas Cart, Wall or Stand mounted
Optimization: Pump operates at 6 psi	Lower pressures for stain applications
Optimization: New filter	Delivers optimum filtration to prevent tip blockages
Optimization: New suction rods (16 mm and 25 mm diameter)	16 mm: recommended for frequent color changes 25 mm: recommended for high viscosity products up to 5,000 cps
Simplicity: Simple design, reduced number of spare parts	Very easy and economical to maintain
Simplicity: Simple and accessible air motor/fluid section coupling without tie rod	Pump servicing is quick and simple
Simplicity: Fluid section with a mobile lower single lip self-adjusting packing	Delivers better sealing and longer working life. It is also better suited for pre-catalyzed materials and needs less solvent to flush than fixed-packing pumps.
Simplicity: Differential air motor	Quiet efficient operation

SPECIFICATIONS	
Pressure ratio	30:1
Fluid volume per cycle (cm ³)	25 (2 x 12.5)
Number of cycles per 33.8 oz (1 liter) of products	40
Fluid output at 30 cycles/mn (L/mn)	25 oz/mn (0.75 L/mn)
Air consumption at 30 cycles/mn at 85 psi (4 bar)	4.2 cfm (7.1 m ³ /h)
Free flow rate	0.4 gal/mn (1.5 L/mn)
Maximum air inlet pressure	94 psi (6.5 bar)
Maximum fluid pressure	2827 psi (195 bar)
Maximum fluid temperature	140°F (60°C)
Sound pressure level	74.9 dBA
Sealing packings	Upper sealing: Stainless steel cartridge with GT sealing Lower sealing: UHMW polyethylene seal
Weight (kg) (w/o support or rods)	16.7 lbs. (7.6 kg)
Wetted parts	Hard chrome stainless steel, treated stainless steel, stainless steel
Height - bare pump	23 in (58.5 cm)
Width - bare pump	6.2 in (15.8 cm)
Depth - bare pump	6.7 in (17 cm)

FITTINGS		
Fitting	Air inlet (valve)	F 3/8 BSP
	Air outlet (atomization air)	M 1/4" NPS
	Fluid inlet	M 26 x 125
	Fluid outlet	#5 JIC

EOS 30-C25 AIRLESS PUMP STAINLESS STEEL

CONFIGURATION OF EOS 30-C-25 AIRLESS - STAINLESS STEEL

Description	Suction Rod	Drain Rod	Fluid Pressure Regulator	Filter Pump Outlet	Part number
30-C25 pump - AIRLESS wall mounted	-	-	●	-	151-145-050
30-C25 pump - AIRLESS wall mounted w/suction rod and filter	Ø 25	-	●	●	151-145-300

REPAIR KIT

Description	Part number
420-4 air motor repair kit	144-130-190
C25 fluid section repair kit	144-130-291

STAND, CART, GRAVITY HOPPER AND RODS (SUCTION AND FLUSHING)

Description	Part number
Wall mounted totem for EOS	151-140-240
Stand for EOS pumps	151-140-210
Single post cart for EOS pump	151-140-220
Gravity hopper (6 liters)	151-140-230
Easyflow suction rod Ø 16 plunging tube length (600 mm)	149-596-050
Easyflow suction rod Ø 16 plunging tube length (1000 mm - for 200 liter drums)	149-596-060
Easyflow suction rod Ø 25 plunging tube length (600 mm)	149-596-150
Easyflow suction rod Ø 25 plunging tube length (1000 mm - for 200 liter drums)	149-596-160
Stainless steel flushing rod F18 x 125	049-596-000



40.25 PUMP

Ideal for outputs up to 0.4 gal/mn (1.5 liter/mn)

FEATURES	BENEFITS
Large diameter suction rod and high compression ratio	Can be used with a wide range of materials
Stainless steel construction	Compatible with water-based products
Simple design, reduced number of spare parts	Easy maintenance

SPECIFICATIONS		
Pressure ratio	40:1	
Fluid volume per cycle	1.7 oz/mn (50 cm ³)	
Number of cycles per 33.8 oz (1 liter) of products	20	
Fluid output at 30 cycles/mn	0.4 gal/mn (1.5 L/mn)	
Air consumption at 30 cycles/mn at 58 psi (4 bar)	12.7 cfm (21.6 m ³ /h)	
Free flow rate	0.8 gal/mn (3 L/mn)	
Maximum air inlet pressure	87 psi (6 bar)	
Maximum fluid pressure	3480 psi (240 bar)	
Maximum fluid temperature	140°F (60°C)	
Sound level	77 dBA	
Sealing packings	Upper sealing	Polyfluid + PTFE G
	Lower sealing	GT seal
Wetted parts	Stainless steel	
Weight - wall-mounted	48.5 lbs (22 kg)	
Height	31.5 in (80 cm)	
Width	15.7 in (40 cm)	
Depth	11 in (28 cm)	

FITTINGS		
Fitting	Air inlet (valve)	F 3/4" BSP
	Fluid inlet	M 26x125
	Fluid output (filter)	M #5 JIC



CONFIGURATION OF THE 40.25 PUMP -STAINLESS STEEL

Set-up	Suction rod	Drain rod	Air regulator Fluid pressure	Pump output filter	Part number
Wall mounted	●	-	●	-	151-775-100
Wall mounted	●	●	●	●	151-775-200
2 arm cart mounted	●	●	●	●	151-775-400

KITS	
Description	Part number
H25 GT seal kit	144-950-091
H25 GT repair kit	144-950-096
Seal kit for 1000-4 air motor	146-270-991
Repair kit for 1000-4 air motor	146-270-995

CARTS AND RODS (SUCTION AND FLUSHING)

Description	Part number
Two post cart w/o plate	051-221-000
Two post pump mounting plate	056-100-199
Easyflow suction rod, 5 gal	149-596-150
Easyflow suction rod, 55 gal	149-596-160
Stainless steel flushing rod F18 x 125	049-596-000





40.25 WB PUMP (WATER-BASED)

Recommended for high viscosity products such as water-based and high solid paints. Ideal for outputs up to 0.4 gal/mn (1.5 liter/mn).

FEATURES	BENEFITS
Large suction fluid passage	For high viscosity materials
Puls-Absorber™ device	Stable and smooth flow
Stainless steel construction	Compatible with water-based products
Stainless steel strainer	Long service life and good reliability No crushing possible
Simple design, reduced number of spare parts	Easy maintenance

SPECIFICATIONS	
Pressure ratio	40:1
Fluid volume per cycle	1.7 oz/mn (50 cm ³)
Number of cycles per 33.8 oz (1 liter) of products	20
Fluid output at 30 cycles/mn	0.4 gal/mn (1.5 L/mn)
Air consumption at 30 cycles/mn at 58 psi (4 bar)	12.7 cfm (21.6 m ³ /h)
Free flow rate	0.8 gal/mn (3 L/mn)
Maximum air inlet pressure	87 psi (6 bar)
Maximum fluid pressure	3480 psi (240 bar)
Maximum fluid temperature	140°F (60°C)
Sound level	77 dBA
Sealing packings	Upper sealing: Polyfluid + PTFE G Lower sealing: GT seal
Wetted parts	Stainless steel
Weight - wall-mounted	48.5 lbs (22 kg)
Height	36.2 in (92 cm)
Width	15.7 in (40 cm)
Depth	11 in (28 cm)

FITTINGS		
Fitting	Air inlet (valve)	F 3/4" BSP
	Air outlet (option atomization air kit)	M 1/4" NPS
	Fluid inlet	M 1"
	Fluid output (filter)	M #5 JIC



CONFIGURATION OF THE 40.25 WB PUMP -STAINLESS STEEL

Set-up	Suction rod	Drain rod	Air regulator Fluid pressure	Pump output filter	Part number
Wall mounted	●	●	●	●	151-775-550
2 arm cart mounted	●	●	●	●	151-775-500

KITS	
Description	Part number
H25 WB seal kit	144-950-991
Repair kit H25 WB	144-950-992
Seal kit for 1000-4 air motor	146-270-991
Repair kit for 1000-4 air motor	146-270-995

CARTS AND RODS (SUCTION AND FLUSHING)	
Description	Part number
Two post cart w/o plate	051-221-000
Two post pump mounting plate	056-100-199
Suction rod 1"	921-270-101
Stainless steel flushing rod F18 x 125	049-596-000



40.50 PUMP

Ideal for feeding two guns

FEATURES	BENEFITS
Simple design, reduced number of spare parts	Easy maintenance
Large diameter suction rod and high compression ratio	Can be used with a wide range of materials

SPECIFICATIONS		
Pressure ratio	40:1	
Fluid volume per cycle	3.4 oz/mn (100 cm ³)	
Number of cycles per 33.8 oz (1 liter) of products	10	
Fluid output at 30 cycles/mn	0.8 gal/mn (3 L/mn)	
Free flow rate	1.6 gal/mn (6 L/mn)	
Air consumption at 30 cycles/mn at 58 psi (4 bar)	25.4 cfm (43.2 m ³ /h)	
Maximum air inlet pressure	87 psi (6 bar)	
Maximum fluid pressure	3480 psi (240 bar)	
Maximum fluid temperature	140°F (60°C)	
Sound level	80 dBA	
Sealing packings	Upper sealing	Polyfluid + PTFE G
	Lower sealing	GT sealing
Wetted parts	Stainless steel	
Weight - wall-mounted	48.5 lbs (22 kg)	
Height	31.5 in (80 cm)	
Width	15.7 in (40 cm)	
Depth	11 in (28 cm)	

FITTINGS		
Fitting	Air inlet (valve)	F 3/4" BSP
	Air outlet (option atomization air kit)	M 1/4" NPS
	Fluid inlet	M 26 x 125
	Fluid output (filter)	M #5 JIC



CONFIGURATION OF THE 40.50 PUMP - STAINLESS STEEL					
Set-up	Suction rod	Drain rod	Air regulator Fluid pressure	Pump output filter	Part number
Wall mounted	●	-	●	-	151-785-100
Wall mounted	●	●	●	●	151-785-200
2 arm cart mounted	●	●	●	●	151-785-400

KITS	
Description	Part number
H50 GT seal kit	144-960-091
H50 GT repair kit	144-960-096
Seal kit for 2000-4 air motor	146-270-990
Repair kit for 2000-4 air motor	146-270-996

CARTS AND RODS (SUCTION AND FLUSHING)	
Description	Part number
Two post cart w/o plate	051-221-000
Two post pump mounting plate	056-100-199
Easyflow suction rod, 5 gal	149-596-150
Easyflow suction rod, 55 gal	149-596-160
Stainless steel flushing rod F18 x 125	049-596-000



40.50 WB PUMP (WATER-BASED)

Recommended for high viscosity products such as water-based and high solid paints. Ideal for outputs up to 0.4 gal/mn (1.5 liter/mn).

FEATURES	BENEFITS
Large suction fluid passage	For high viscosity materials
Puls-Absorber™ device	Stable and smooth flow
Stainless steel construction	Compatible with water-based products
Stainless steel strainer	Long service life and good reliability No crushing possible
Simple design, reduced number of spare parts	Easy maintenance

SPECIFICATIONS		
Pressure ratio	40:1	
Fluid volume per cycle	3.4 oz/mn (100 cm ³)	
Number of cycles per 33.8 oz (1 liter) of products	10	
Fluid output at 30 cycles/mn	0.8 gal/mn (3 L/mn)	
Air consumption at 30 cycles/mn at 58 psi (4 bar)	25.4 cfm (43.2 m ³ /h)	
Free flow rate	1.6 gal/mn (6 L/mn)	
Maximum air inlet pressure	87 psi (6 bar)	
Maximum fluid pressure	3480 psi (240 bar)	
Maximum fluid temperature	140°F (60°C)	
Sound level	80 dBA	
Sealing packings	Upper sealing	Polyfluid + PTFE G
	Lower sealing	GT seal
Wetted parts	Stainless steel	
Weight - wall-mounted	48.5 lbs (22 kg)	
Height	36.2 in (92 cm)	
Width	15.7 in (40 cm)	
Depth	11 in (28 cm)	

FITTINGS		
Fitting	Air inlet (valve)	F 3/4" BSP
	Air outlet (option atomization air kit)	M 1/4" NPS
	Fluid inlet	M 1"
	Fluid output (filter)	M #8 JIC



CONFIGURATION OF THE 40.50 WB PUMP -STAINLESS STEEL					
Set-up	Suction rod	Drain rod	Air regulator Fluid pressure	Pump output filter	Part number
Wall mounted	●	●	●	●	151-785-550
2 arm cart mounted	●	●	●	●	151-785-500

FITTING TO CONNECT AN AIRLESS GUN KIT	
Description	Part number
Adaptator stainless steel F #8 JICart mount #5 JIC	905-160-219

KITS	
Description	Part number
H50 WB seal kit	144-960-891
H50 WB repair kit	144-960-892
Seal kit for 2000-4 air motor	146-270-990
Repair kit for 2000-4 air motor	146-270-996

CARTS AND RODS (SUCTION AND FLUSHING)	
Description	Part number
Two post cart w/o plate	051-221-000
Two post pump mounting plate	056-100-199
Suction rod 1"	921-270-101
Stainless steel flushing rod F18 x 125	049-596-000



34.A2 FLOWMAX® PUMP

Unique design with external valves for easy maintenance. Flowmax technology ensures total sealing. Quick inversion of this pump allows for a perfectly stable fan shape at the gun. Performance, extended lifetime, reliability.

FEATURES	BENEFITS
External valves assembly	Easy maintenance
Floating piston	Fast inversions and very high efficiency
Sealing done by a Superlife™ Bellows seal	High reliability No more lubricant cups Leak free Total sealing between pump and its environment, ideal to work with moisture-sensitive catalysts Ideal for UV and pre-catalyzed materials
Large and smooth fluid passages	Fluid discharge without retention of a wide range of coating materials
Stainless steel construction	Compatible with water-based materials
Balanced fluid section	Constant fluid output pressure

SPECIFICATIONS		
Pressure ratio	34:1	
Fluid volume per cycle	2 oz/mn (60 cm³)	
Number of cycles per 33.8 oz (1 liter) of products	16	
Fluid output at 30 cycles/mn	.048 gal/mn (1.8 L/mn)	
Air consumption at 30 cycles/mn at 58 psi (4 bar)	12.9 cfm (22 m³/h)	
Free flow rate	0.95 gal/mn (3.6 L/mn)	
Maximum air inlet pressure	87 psi (6 bar)	
Maximum fluid pressure	2900 psi (200 bar)	
Maximum fluid temperature	122°F (50°C)	
Sound level	71 dBA	
Sealing packing	Bellows	Polyethylene
	Upper and lower	GT Polyethylene
Wetted parts	Stainless steel	
Weight - wall-mounted	58.4 lbs (26.5 kg)	
Height	24 in (61 cm)	
Width	16.1 (41 cm)	
Depth	9.8 in (25 cm)	

FITTINGS		
Fitting	Air inlet (valve)	F 3/4" BSP
	Air outlet (option atomization air kit)	M 1/4" NPS
	Fluid inlet	M 26 x 125
	Fluid output (filter)	#5 JIC

CONFIGURATION OF THE FLOWMAX® 34.A2 PUMP

Set-up	Suction rod	Drain rod	Air regulator Fluid pressure	Pump output filter	Part number
Wall-mounted	●	●	●	●	151-740-700
Cart-mounted	●	●	●	●	151-740-750

KITS	
Description	Part number
Seal kit for A2 fluid section	144-910-799
Repair kit for A2 fluid section	144-910-797
Seal kit for external valves	144-910-798
Seal kit for 2000-2 air motor	144-929-902
Repair kit for 2000-2 air motor	144-929-912

CARTS AND RODS (SUCTION AND FLUSHING)

Description	Part number
Two post cart w/o plate	051-221-000
Two post pump mounting plate	056-100-199
Easyflow suction rod, 5 gal	149-596-150
Easyflow suction rod, 55 gal	149-596-160
Stainless steel flushing rod F18 x 125	049-596-000





40.25F FLOWMAX® PUMP

New generation Flowmax® pump for low volume applications

FEATURES	BENEFITS
Sealing done by one large stroke Bellows	High reliability No more lubricant cups Leak free Total sealing - ideal for isocyanates Ideal for UV and pre-catalyzed materials
Ergonomic design of fluid passages	Fluid discharge without retention of a wide range of coating materials
Stainless steel construction	Compatible with water-based materials
Balanced fluid section	Constant fluid output pressure
Mobile piston seal	Excellent suction capacity

SPECIFICATIONS		
Pressure ratio	40:1	
Fluid volume per cycle	1.7 oz/mn (50 cm ³)	
Number of cycles per 33.8 oz (1 liter) of products	20	
Air consumption at 30 cycles/mn at 58 psi (4 bar)	12.7 cfm (21.6 m ³ /h)	
Fluid output at 30 cycles/mn	0.4 gal/mn (1.5 L/mn)	
Free flow rate	0.8 gal/mn (3 L/mn)	
Maximum fluid pressure	3480 psi (240 bar)	
Maximum fluid temperature	122°F (50°C)	
Maximum air inlet pressure	87 psi (6 bar)	
Sound level	72 dBA	
Sealing packing	Bellows	Polyethylene
	Upper and lower	GT polyethylene
Wetted parts	Stainless steel	
Weight - wall-mounted	82 lbs (37 kg)	
Height	38.2 in (97 cm)	
Width	15.7 in (40 cm)	
Depth	11 in (28 cm)	

FITTINGS		
Fitting	Air inlet (valve)	F 3/4" BSP
	Fluid inlet	M 26 x 125
	Fluid outlet	M #5 JIC



CONFIGURATION OF THE FLOWMAX® 40.25F PUMP - STAINLESS STEEL

Set-up	Suction rod	Drain rod	Air regulator Fluid pressure	Pump output filter	Part number
Wall mounted	●	●	●	●	151-776-200
Cart-mounted	●	●	●	●	151-776-400

KITS	
Description	Kit part number
Seal kit H25F	144-950-291
Repair kit H25F	144-950-292
Seal kit for 1000-4 air motor	146-270-991
Repair kit for 1000-4 air motor	146-270-995

CARTS AND RODS (SUCTION AND FLUSHING)

Description	Kit part number
Two post cart w/o plate	051-221-000
Two post pump mounting plate	056-100-199
Easyflow suction rod, 5 gal	149-596-150
Easyflow suction rod, 55 gal	149-596-160
Stainless steel flushing rod F18 x 125	049-596-000



40.50FT FLOWMAX® PUMP

New generation Flowmax® pump, ideal for feeding two guns

FEATURES	BENEFITS
Sealing done by one large stroke Bellows	High reliability No more lubricant cups Leak free Total sealing between pump and its environment, ideal to work with moisture-sensitive catalysts Ideal for UV and pre-catalyzed materials
Ergonomic design of fluid passages	Fluid discharge without retention of a wide range of coating materials
Stainless steel construction	Compatible with water-based materials
Balanced fluid section	Constant fluid output pressure
Mobile piston seal	Excellent suction capacity

SPECIFICATIONS	
Pressure ratio	40:1
Fluid volume per cycle	3.4 oz/mn (100 cm³)
Number of cycles per 33.8 oz (1 liter) of products	10
Air consumption at 30 cycles/mn at 58 psi (4 bar)	25.4 cfm (43.2 m³/h)
Fluid output at 30 cycles/mn	0.8 gal/mn (3 L/mn)
Free flow rate	1.6 gal/mn (6 L/mn)
Maximum fluid pressure	3480 psi (240 bar)
Maximum fluid temperature	122°F (50°C)
Maximum air inlet pressure	87 psi (6 bar)
Sound level	77 dBA
Sealing packing	Bellows: Polyethylene Upper and lower: GT Polyethylene
Wetted parts	Stainless steel
Weight - wall-mounted	42
Height	38.2 in (97 cm)
Width	15.7 in (40 cm)
Depth	11 in (28 cm)

FITTINGS		
Fitting	Air inlet (valve)	F 3/4" BSP
	Fluid inlet	M 26x125
	Fluid outlet	M #5 JIC



Model shown
40.50 FT

CONFIGURATION OF THE FLOWMAX® 40.50F PUMPS- STAINLESS STEEL					
Set-up	Suction rod	Drain rod	Air regulator Fluid pressure	Pump output filter	Part number
Wall mounted	●	-	●	-	151-786-100
Wall mounted	●	●	●	●	151-786-200
Cart-mounted	●	●	●	●	151-786-400

KITS	
Description	Part number
Seal kit H 50F	144-960-291
Repair kit H 50F	144-960-292
Seal kit for 2000-4 air motor	146-270-990
Repair kit for 2000-4 air motor	146-270-996

CARTS AND RODS (SUCTION AND FLUSHING)	
Description	Part number
Two post cart w/o plate	051-221-000
Two post pump mounting plate	056-100-199
Easyflow suction rod, 5 gal	149-596-150
Easyflow suction rod, 55 gal	149-596-160
Stainless steel flushing rod F18 x 125	049-596-000





40.130F FLOWMAX® PUMP

Recommended for anti-corrosion applications

FEATURES	BENEFITS
Sealing done by one large stroke Bellows	High reliability No more lubricant cups Leak free Total sealing between pump and its environment, ideal to work with moisture-sensitive catalysts Ideal for UV and pre-catalyzed materials
Ergonomic design of fluid passages	Fluid discharge without retention of a wide range of coating materials
Stainless steel construction	Compatible with water-based materials
Balanced fluid section	Constant fluid output pressure
Mobile piston seal	Excellent suction capacity

SPECIFICATIONS		
Pressure ratio	40:1	
Fluid volume per cycle	8.1 oz/mn (240 cm³)	
Number of cycles per 33.8 oz (1 liter) of products	4	
Fluid output at 20 Cycles/mn	1.27 gal/mn (4.8 L/mn)	
Free flow rate	3.8 gal/mn (14.4 L/mn)	
Maximum fluid pressure	3480 psi (240 bar)	
Maximum fluid temperature	122°F (50°C)	
Maximum air inlet pressure	87 psi (6 bar)	
Sound level	85 dBA	
Sealing packing	Bellows	Polyethylene
	Upper and lower	GT polyethylene
Wetted parts	Stainless steel, Carbide, Hard chromed stainless steel	
Weight	154 lbs (70 kg)	
Height	44 in (112 cm)	
Width	25.6 in (65 cm)	
Depth	12.8 in (32.5 cm)	

FITTINGS		
Fitting	Air inlet	F 3/4" BSP
	Fluid inlet	M 38 x 150
	Fluid outlet	M #8 JIC



CONFIGURATION OF THE FLOWMAX® 40.130F PUMP- STAINLESS STEEL					
Set-up	Suction rod	Drain rod	Air regulator Fluid pressure	Pump output filter	Part number
Wall mounted	-	-	●	-	151-871-500
Wall mounted	●	-	●	●	151-871-600
Cart-mounted	●	-	●	●	151-871-700

KITS	
Description	Part number
H 130F-2 seals kit	144-020-690
H 130F seals kit	144-020-090
H 130F-2 repair kit	144-020-695
H 130F repair kit	144-020-095
Seal kit 5000-4-2 air motor	146-280-991
Seal kit 5000-4 air motor	146-280-990
Repair kit 5000-4-2 air motor	146-280-996
Repair kit 5000-4 air motor	146-280-995

CARTS AND RODS (SUCTION AND FLUSHING)	
Description	Part number
Two reinforced arms w/o mounting plate	051-231-000
Pump bracket	051-341-206
Suction rod Ø25 plunging tube length 23.6 in (600 mm)	049-597-100
Stainless steel flushing rod F18 x 125	049-596-000

■ Screen and cartridges for fluid filter

SCREEN CONFIGURATION (FILTRATION SURFACE 65 CM²)

Filter number	Filtration size		Nozzle size	Part number
	Micron	Mesh		
1	40	325	3	000-161-101
2	74	200	4	000-161-102
3	90	170	4	000-161-103
4	100	140	4	000-161-104
6	168	85	6	000-161-106
8	210	70	09 & 14	000-161-108
12	280	55	20	000-161-112
15	360	45	30 & 45	000-161-115
20	510	30	> 68	000-161-020
30	750	20	> 68	000-161-030

CONFIGURATION FILTRATION CARTRIDGE STAINLESS STEEL (FILTRATION SURFACE 132 CM²)

Description	Filtration size		Nozzle size	Part number
	Micron	Mesh		
Filtration cartridge Stainless steel	90	170	4	601241
Filtration cartridge Stainless steel	102	140	4	601240
Filtration cartridge Stainless steel	160	83	6	601239
Filtration cartridge Stainless steel	201	65	9 - 20	601324
Filtration cartridge Stainless steel	350	45	30 - 68	601238
Filtration cartridge Stainless steel	710	25	> 68	601237

CONFIGURATION FILTRATION CARTRIDGE STEEL (FILTRATION SURFACE 132 CM²)

Description	Filtration size		Nozzle size	Part number
	Micron	Mesh		
Filtration cartridge steel	90	170	4	601093
Filtration cartridge steel	102	140	4	601090
Filtration cartridge steel	160	83	6	601089
Filtration cartridge steel	201	65	9 - 20	601287
Filtration cartridge steel	350	45	30 - 68	601092
Filtration cartridge steel	710	25	> 68	601084

■ Strainers for suction rods

STRAINERS CONFIGURATION

Pump	Height	Internal diameter	Material	Filtration size		Part number
				Micron	Mesh	
40.130-2 / 40.130 F2 / 65.130 / 65.130 F2	4.4 in (112 mm)	2.6 in (66 mm)	Polyamide	1000	15	149-591-400
40.25/40.50WB	1.6 in (40 mm)	1.9 in (48 mm)	Stainless steel	1000	15	921-270-102
34.A2 / 40.25 / 40.25F / 40.50 / 40.50F / Easy Flush Ø25	1.6 in (40 mm)	1.9 in (48 mm)	Stainless steel	1000	15	149-596-152



CYCLIX™ AGITATORS FOR 5-55 GAL (20-200 L) DRUMS



This elevator-agitator for 5-55 gal (20-200 L) drums features a bi-directional jack for a fast lift of a stainless steel cover fitted for a quick material drum change. The cover is equipped with a motorized agitator fitted with blades for low viscosity materials and a full stainless steel rod.

The elevator features a large mounting plate which makes it very stable and easy to install in paint kitchens, existing installations or an essential component of new installations.



FEATURES	BENEFITS
Stainless steel (agitator cover, suction and drain rods)	Compatibility with all materials
Adjustable suction rod height	No product loss
Suction and return tubes	Suitable for recirculating
Double effect jack with 3 position command lever: up, stop, down	Important flexibility
The agitator cannot work during elevator movements	Security

CHARACTERISTICS		
Capacity	5 gal (20 L)	55 gal (200 L)
Motor type	Pneumatic	Pneumatic
Reductor type	-	Gear drive
Rotation speed (rpm)	60 - 300	5 - 90
Motor torque	Nm	2.2
		34

CYCLIX™ PART NUMBERS FOR 55 GAL (200 L) DRUMS					
Description	Elevator height	Agitator rod length	Paddle diameter	Cover diameter	Part number
Elevator for 55 gal (200 L) drums	59.4 in min - 94.8 in max 1510 mm (mini) - 2410 mm (maxi)	-	-	-	62-2512-00

PART NUMBERS	
Description	Part number
Agitator, 5 gallon, c/w cover, bare elevator	668-668-806
Agitator, 5 gallon, c/w flange, w/o cover, S/S blade	668-332-600
Agitator, 55 gallon, w/o cover	668-668-324
Agitator, 55 gallon, c/w elevator, cover, gear drive	668-000-551
Agitator, 55 gallon, c/w cover, elevator, bracket, direct drive	668-900-225
Agitator, 55 gallon, c/w cover, gear drive	668-000-606
Agitator, 55 gallon, S/S, cover, nylon blade	668-668-320

RECOMMENDED ACCESSORIES	
Description	Part number
1/4" air lubricator + support	154-261-997
Exhaust assembly with oil recovery (length 1 m)	154-261-996
Air feeding kit	154-261-930
Drum roller unit for 55 gal (200 liter) drum	151-098-100
Slotted paddle for thick materials	154-261-952



■ AIRLESS polyamide fluid hoses



- Those hoses should be chosen according to the diameter, the length and the pressure used in the application

HOSES CONFIGURATION SINGLE BRAIDED HOSE

Description	Part number			
Conductive	YES			
Color	Black			
Internal diameter	4.8 (3/16")	6.35 (1/4")	9.52 (3/8")	12.7 (1/2")
Max. operating pressure bar	4712 psi (325 bar)	4350 psi (300 bar)	3262 psi (225 bar)	2537 psi (175 bar)
Temperature	up to 212°F (100°C)			
Cut of 25 m without fitting			050-450-005	
Fitting alone to screw in	-		905-060-107	
PART NUMBER ACCORDING TO LENGTH WITH FITTINGS per meter				
A and B fittings (swivel)	1/2 JIC	1/2 JIC	3/4 JIC	7/8 JIC
Treated steel fittings				
Without spring				
1' 7" (0.5 m)		76022	76035	
3' 3" (1 m)	76.010	76023	76036	76049
6' 5" (2 m)	76.012	76025	76038	76051
9' 10" (3 m)		76026	76039	
16' 5" (5 m)		76028	76041	
19' 8" (6 m)	76.016	76029	76042	
22' 11" (7 m)		76030	76043	76056
26' 3" (8 m)		76031	76044	76057
32' 9" (10 m)		76033	76046	
39' 4" (12 m)		76034		

HOSES CONFIGURATION DOUBLE BRAIDED HOSE

Description	Part number				
Conductive	YES				
Color	Black				
Internal diameter	6.35 (1/4")	6.35 (1/4")	9.52 (3/8")	9.52 (3/8")	12.7 (1/2")
Max. operating pressure bar	6525 psi (450 bar)	7250 psi (500 bar)	5437 psi (375 bar)	6162 psi (425 bar)	5437 psi (375 bar)
Temperature	up to 212°F (100°C)				
PART NUMBER ACCORDING TO LENGTH WITH FITTINGS PER METER					
A and B fittings (swivel)	1/2 JIC	1/2 JIC	3/4 JIC	3/4 JIC	7/8 JIC
Treated steel fittings					
Without spring					
1' 7" (0.5 m)				76074	
3' 3" (1 m)	050-451-001		050-450-905		
6' 5" (2 m)		76064		76077	76090
9' 10" (3 m)		76065	050-450-904		76091
16' 5" (5 m)	050-451-002	76067	050-450-903	76080	76093
19' 8" (6 m)				76081	76094
26' 3" (8 m)		76070			76096
32' 9" (10 m)	050-451-003		050-450-902	76085	
39' 4" (12 m)		76073		76086	
45' 11" (14 m)				76842	
59' 1" (18 m)				76844	
65' 7" (20 m)			050-450-901		

■ AIRLESS PTFE fluid hoses



For all products, particularly those which are sensitive to air humidity (like silicone) and those which are chemically aggressive.

HOSES CONFIGURATION

Description	Part number					
Material color	Grey with metallic braid					
Internal diameter	3/16 in (4.8 mm)	1/4 in (6.35 mm)	3/8 in (9.52 mm)	3/8 in (9.52 mm)	1/2 in (12.7 mm)	1/2 in (12.7 mm)
Conductive	YES					
Maximum Operating pressure (bar)	3625 psi (250 bar)	3625 psi (250 bar)	2537 psi (175 bar)	5075 psi (350 bar)	5075 psi (350 bar)	5075 psi (350 bar)
Temperature	≤ 230°F (110°C)					
Fittings A and B (swivel)	1/2 JIC	1/2 JIC	3/4 JIC	3/4 JIC	3/4 JIC	7/8 JIC
1' 1" (0.60 m)	055-729-516	-	-	-	-	-
2' 3" (0.70 m)	-	-	050-451-904	-	-	-
3' 3" (1 m)	-	050-452-001	050-451-903	-	-	-
6' 5" (2 m)	-	-	050-451-901	76800	050-452-204	76872
9' 10" (3 m)	-	-	-	76801	-	76874
16' 5" (5 m)	-	050-452-002	050-451-902	76802	-	76928
22' 11" (7 m)	-	-	-	76803	050-452-201	-
32' 9" (10 m)	-	-	-	76914	050-452-203	-

■ Product hoses for suction rod

HOSE FOR SUCTION ROD

Description	Part number		
Polyethylene hose sleeve	Ø 0.374 in Ø 9.5 mm	Ø 0.748 in Ø 19 mm	Ø 0.984 in Ø 25 mm
16' 5" (5 m) cut	050-361-005	050-366-051	050-367-001
49' 2" (15 m) cut	050-361-004	050-366-052	-
82' (25 m) cut	050-361-001	050-366-053	050-367-003
Grooved conical fitting	050-140-517	050-140-545	050-140-543
Nickeled nut fitting	050-271-303	050-271-502	049-595-306
1 wing collar	906-311-234	906-311-207	906-311-204

■ Lubricants and greases for pumps

LUBRICANT FOR PUMP PACKINGS

Description	Part number
Lubricants for pump fittings	
Lubricant T 8.4 oz (1/4 L) can for solvent-based paints	149-990-020
Lubricant T 1 gal (128 fl oz)	668-990-001
Lubricant T 1 qt (32 fl oz)	668-990-002
Lubricant P 1 gal (128 fl oz)	668-990-021
Lubricant P 1 qt (32 fl oz)	668-990-022
Grease	
Vaseline 2.2 lbs (1 kg) "special PMP"	560-440-002
Box of 15.8 oz (450 g) PTFE grease	560-440-001
Techni Lub tube	560-440-101
Box of grease 15.8 oz (450 g)	560-420-005



■ Gun cleaning kit

PART NUMBERS

Description	Part number
Gun cleaning kit	668-000-395

1/4 in (6.4 mm) nylon brush
 Gun lubricant
 Tip cleaning needles
 Cleaning needle pin vise
 Contains all necessary items for spray gun maintenance





ELECTROSTATIC EQUIPMENT

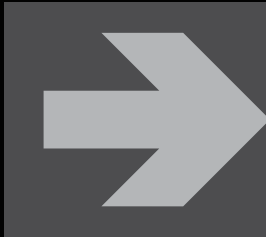

NANO GUN



Taking full advantage of our 65 years of expertise with electrostatic technology, SAMEs has developed the only electrostatic gun to spray with BOTH high current and high voltage, guaranteeing:

- Optimal paint coverage
- Efficient paint transportation to the part

This combination delivers up to 20% higher transfer efficiencies compared to previous gun designs.

NANO GUN | MV



FEATURES	BENEFITS
Increased operator comfort	Reduces fatigue
Increased Transfer Efficiency	Significant paint and air savings
Two gun versions available	Compatible with solvent-based or water-based paint
Reduced number of components	Easy to Maintain
Intuitive controls	Easy to adjust controls
Aircap innovation	Super Vortex technology for finest atomizations
Comes in with gun wrench	Simple maintenance

SPECIFICATIONS	
Maximum air supply pressure	101 psi (7 bar)
Maximum paint supply pressure	101 psi (7 bar)
Weight	20 oz (570 g) w/o hose or cable
Maximum paint flow	25.3 oz/min (750 cc/mn)
Pattern max width	15" / (381 mm)
Recommended product viscosity	14 s to 50 s CA 4
Maximum tip voltage (Kv)	60
Maximum current μA	80
Maximum temperature	140°F (60°C)
Hose length options	25', 50, 82' / (7.5, 15, 25m)
Type of spray	Super Vortex round spray dia. 8, 12, 16mm (option)
Wetted parts	Stainless steel - Polyamide - PETP - PTFE - Polyacetal - Polyethylene

FITTINGS		
Fitting	Air	M 1/4" NPS
	Fitting (resistivity > 5Mohms.cm)	M #5 JIC
	Fitting (resistivity < 5Mohms.cm)	F #5 JIC

ATEX marking

** depending on viscosity*

NANO GUN MV CII, Gp D, Spray Mit
Refer to manual 7105
CE 0080 Ex II 2 G
0.24mJ
INERIS14ATEX014



GNM6080
CE 0080 Ex II 2 G
(0.24mJ)
INERIS14ATEX014



NANO GUN SPRAY GUN CONFIGURATION

Description	Fan shape	Aircap	Nozzle	Voltage cable length	Part number
			Caliber		
	Flat			32.8 ft (10 m)	
	Super Vortex		Swirling fan	49.2 ft (15 m)	

FITTING TO CONNECT WITH AIRSPRAY PUMPS (PMP 150/02.75)

Description	Part number
Adaptor F 3/8" NPS/M#5 JIC	050-123-306

NANOGUN REPAIR KIT

Description	Part number
Nanogun repair kit (cartridge, nozzle, needle, aircap and seals)	

■ Aircaps, tips, needles for Nanogun

TIPS, AIRCAPS AND NEEDLES FOR AUTOMATIC GUNS

Gun type	Aircap w/o ring		Part number	Tip		Needle automatic guns	
	Type	Air flow-rate		Size (mm)	Fluid output	Part number	Part number
KMV	KMV	9.4 cfm at 58 psi (16 Nm ³ /h at 4 bar)	129-277-354	Swirling fan 33.8 oz/n at 21.7 psi (1000 cm ² /mn at 1.5 bar)		129-277-040	129-277-100



NANOGUN C/W GNM 6080

Description	Part number
GUN,NANOGUN,LP/HR,FAN SPRAY	910016710
GUN,NANOGUN,LP/HR,SSV 12	910016711
GUN,NANOGUN,LP/HR,SSV 08	910016712
GUN,NANOGUN,LP/LR,FAN SPRAY, C/W 7.5m LR HOSE	910017188-075
GUN,NANOGUN,LP/LR,SSV 12,C/W 7.5m LR HOSE	910017189-075
GUN,NANOGUN,LP/LR,SSV 08,C/W 7.5m LR HOSE	910017190-075
GUN,NANOGUN,LP/LR,FAN SPRAY, C/W 15m LR HOSE	910017188-150
GUN,NANOGUN,LP/LR,SSV 12, C/W 15m LR HOSE	910017189-150
GUN,NANOGUN,LP/LR,SSV 08, C/W 15m LR HOSE	910017190-150
GUN,NANOGUN,LP/LR,FAN SPRAY, C/W 7.5m CABLE/HOSE,GNM	910017221-072
GUN,NANOGUN,LP/LR,SSV 08, C/W 7.5m CABLE/HOSE,GNM	910017222-072
GUN,NANOGUN,LP/HR,FAN SPRAY, C/W 7.5m CABLE/HOSE,GNM	910017223-072
GUN,NANOGUN,LP/HR,SSV 08, C/W 7.5m CABLE/HOSE,GNM	910017224-072
GUN,NANOGUN,LP/HR,SSV 12, C/W 7.5m CABLE/HOSE,GNM	910017741-072
GUN,NANOGUN,LP/LR,SSV 12, C/W 7.5m CABLE/HOSE,GNM	910017742-072
GUN,NANOGUN,LP/LR,FAN SPRAY, C/W 15m CABLE/HOSE,GNM	910017221-152
GUN,NANOGUN,LP/LR,SSV 08, C/W 15m CABLE/HOSE,GNM	910017222-152
GUN,NANOGUN,LP/HR,FAN SPRAY, C/W 15m CABLE/HOSE,GNM	910017223-152
GUN,NANOGUN,LP/HR,SSV 08, C/W 15m CABLE/HOSE,GNM	910017224-152
GUN,NANOGUN,LP/HR,SSV 12, C/W 15m CABLE/HOSE,GNM	910017741-152
GUN,NANOGUN,LP/LR,SSV 12, C/W 15m CABLE/HOSE,GNM	910017742-152

KMV 3

MANUAL ELECTROSTATIC GUNS



Vortex spray pattern is perfect for complex tubular parts such as tubes, frameworks, chassis, tables.

Compliant with ATEX Directive:
 INERIS 03 ATEX 0026X
 II 2 G
 EEX 0.24 mJ

To be used in zone 1



FEATURES	BENEFITS
Fewer components	Easy field repair
Wide range available	For a large range of materials
Built-in HT generator	Low voltage cable and user-friendly operation
Adjustable high voltage with integrated safety circuit	Adjustment of the electrostatic effect to the part to be painted and the fluid sprayed
Light and ergonomic	User friendly
Option: ventilated air double sleeve hose	Maximum wrap-around effect for materials with resistivity lower than 5 Mohms.cm
Comes in a case complete with gun wrench and screwdriver, gun cover, hose sleeve, laminated safety sheet, service manual, aircap and KMV nozzle	Ready to use gun/quick and simple maintenance



SPECIFICATIONS	
Maximum air inlet pressure	87 psi (6 bar)
Maximum fluid pressure	145 psi (10 bar)
Weight	w/o hose or cable 28.2 oz (800 g)
Fluid flow rate - max	0.26 gal/mn (1 L/mn)
Fan width	7.8 in (20 cm)
Total length	11.2 in (28.5 cm)
Recommended fluid viscosity	40 s CA4 maxi
Probe voltage	20 - 85 kV
Maximum current	100 µA
Maximum temperature	140°F (60°C)
Wetted parts	Stainless steel - Polyamide - PETP - PTFE - Polyacetal - Polyethylene

FITTINGS		
Fitting	Air	M 1/4" NPS
	Fitting (resistivity > 5Mohms.cm)	M #5 JIC
	Fitting (resistivity < 5Mohms.cm)	F #5 JIC



KMV 3  SPRAY GUN CONFIGURATION					
Description	Fan shape	Aircap	Nozzle	Voltage cable length	Part number
			Caliber		
KMV3  gun	Round	KMV	Swirling fan	32.8 ft (10 m)	135-287-420
KMV3  gun	Round	KMV	Swirling fan	49.2 ft (15 m)	135-287-425

KMV3  C/W STD9	
Description	Part number
KIT, GUN, KMV3  C/w STD9, 32 ft	668-287-420
KIT, GUN, KMV3  C/w STD9, 50 ft	668-287-425



FITTING TO CONNECT WITH AIRSPRAY PUMPS (PMP 150/02.75)

Description	Part number
Adaptor F 3/8" NPS/M#5 JIC	050-123-306

KMV3  REPAIR KIT

Description	Part number
KMV3  repair kit (cartridge, nozzle, needle, aircap and seals)	129-277-355

■ Aircaps, tips, needles for KMV3 

TIPS, AIRCAPS AND NEEDLES FOR AUTOMATIC GUNS

Gun type	Aircap w/o ring		Part number	Tip		Needle automatic guns	
	Type	Air flow-rate		Size (mm)	Fluid output	Part number	Part number
KMV	KMV	9.4 cfm at 58 psi (16 Nm ³ /h at 4 bar)	129-277-354	Swirling fan	33.8 oz/n at 21.7 psi (1 000 cm ³ /mn at 1.5 bar)	129-277-040	129-277-100

AIRCAP RINGS

Description	Part number
Aircap ring for KMV/KAV	129-277-370

KMP 3

MANUAL ELECTROSTATIC GUNS



Ideal for all parts requiring a high quality finish combined with a excellent edge covering for office furniture, rolling equipment, accessories ...

Compliant with ATEX Directive:
 INERIS 03 ATEX 0026X
 II 2 G
 EEX 0,24 mJ

To be used in zone 1



FEATURES	BENEFITS
Fewer components	Easy field repair
Wide range available	For a large range of materials
Built-in HT generator	Low voltage cable and user-friendly operation
Adjustable high voltage with integrated safety circuit	Adjustment of the electrostatic effect to the part to be painted and the fluid sprayed
Light and ergonomic	User friendly
Option: ventilated air double sleeve hose	Maximum wrap-around effect for materials with resistivity lower than 5 Mohms.cm
Comes in a case complete with gun wrench and screwdriver, gun cover, hose sleeve, laminated safety sheet, service manual, KP3 aircap and Ø1,2	Ready to use gun/quick and simple maintenance



SPECIFICATIONS	
Maximum air inlet pressure	87 psi (6 bar)
Maximum fluid pressure	145 psi (10 bar)
Weight	w/o hose or cable 28.2 oz (800 g)
Fluid flow rate	0.26 gal/mn (1 L/mn)
Fan width	7.8 in (20 cm)
Total length	11.2 in (28.5 cm)
Recommended fluid viscosity	40 s CA4 maxi
Probe voltage	20 - 85 kV
Maximum current	100 µA
Maximum temperature (°C)	140°F (60°C)
Wetted parts	Stainless steel - Polyamide - PETP - PTFE - Polyacetal - Polyethylene

FITTINGS		
Fitting	Air	M 1/4" NPS
	Fitting (resistivity > 5Mohms.cm)	M #5 JIC
	Fitting (resistivity < 5Mohms.cm)	F #5 JIC



KMP 3  SPRAY GUN CONFIGURATION					
Description	Fan shape	Aircap	Tip	Voltage cable length	Part number
			Size		
KMP3  spray gun	Flat	KP3	0.047 in (1.2 mm)	32.8 ft (10 m)	135-286-420
KMP3  spray gun	Flat	KP3	0.047 in (1.2 mm)	49.2 ft (15 m)	135-286-425

KMP3  C/W STD9	
Description	Part number
 KIT, GUN, KMP3  C/w STD9	668-286-420

FITTING TO CONNECT WITH AIRSPRAY PUMPS (PMP 150/02.75)

Description	Part number
Adaptors F 3/8" NPS/M#5 JIC	050-123-306

KMP3  REPAIR KIT

Description	Part number
KMP3  repair kit (cartridge, nozzle, needle, aircap and seals)	129-276-350

■ Aircaps, tips, needles for KMP 3 **TIPS, AIRCAPS AND NEEDLES FOR AUTOMATIC GUNS**

Gun type	Type	Aircap w/o ring		Tip		Needle automatic guns	
		Air flow-rate	Part number	Size	Fluid output	Part number	Part number
KMP	KP3	14.1 cfm at 58 psi (24 N m ³ /h at 4 bar)	132-286-000	supplied with gun 0.047 in (Ø 1.2 mm)	20.3 oz/mn at 87 psi (600 cm ³ /mn at 4 bar)	129-276-205	129-276-100
KMP	KP3	14.1 cfm at 58 psi (24 N m ³ /h at 4 bar)	132-286-000	0.059 in (Ø 1.5 mm)	27.1 oz/mn at 87 psi (800 cm ³ /mn at 4 bar)	129-276-220	129-276-100

AIRCAP RINGS

Description	Part number
Aircap ring for KMP/KAV	129-277-370

KMX 3

MANUAL ELECTROSTATIC GUNS



Ideal for large parts that require Airmix® finish quality.

Compliant with ATEX Directive:
 INERIS 03 ATEX 0026X
 II 2 G
 EEX 0,24 mJ

To be used in zone 1

FEATURES	BENEFITS
Fewer components	Easy field repair
Wide range available	For a large range of materials
Built-in HT generator	Low voltage cable and user-friendly operation
Adjustable high voltage with integrated safety circuit	Adjustment of the electrostatic effect to the part to be painted and the fluid sprayed
Light and ergonomic	User friendly
Option: ventilated air double sleeve hose	Maximum wrap-around effect for materials with resistivity lower than 5 Mohms.cm
Comes in a case complete with gun wrench and screwdriver, gun cover, hose sleeve, laminated safety sheet, service manual, KX16 aircap and 09,135 tip	Ready to use gun/quick and simple maintenance





SPECIFICATIONS	
Maximum air inlet pressure	87 psi (6 bar)
Maximum fluid pressure	145 psi (10 bar)
Weight	w/o hose or cable 28.2 oz (800 g)
Fluid output	Depends on the tip used
Fan width	Upon tip and adjustable by aircap rotation
Total length	11.2 in (28.5 cm)
Recommended fluid viscosity	40 s CA4 maxi
Probe voltage	20 - 85 kV
Maximum current	100 µA
Maximum temperature	140°F (60°C)
Wetted parts	Stainless steel - Polyamide - PETP - PTFE - Polyacetal - Polyethylene

FITTINGS		
Fitting	Air	M 1/4" NPS
	Fitting (resistivity > 5Mohms.cm)	M #5 JIC
	Fitting (resistivity < 5Mohms.cm)	F #5 JIC



KMX 3 GUN CONFIGURATION

Description	Fan shape	Aircap	Tip	Voltage cable length	Part number
			Size (mm)		
KMX3  spray gun	Flat	KX 16	09.135	32.8 ft (10 m)	135-284-420
KMX3  spray gun	Flat	KX 16	09.135	49.2 ft (15 m)	135-284-425

KMX3 REPAIR KIT

Description	Part number
KMX3  repair kit (cartridge, tip, needle, aircap and seals)	129-274-350

KMX3  C/W STD9	
Description	Part number
KMX3  C/w STD9 32 ft hose filter	668-284-420
KMX3  C/w STD9 50 ft hose filter	668-284-425

■ Aircaps, tips, needles for KMX 3

AIRCAPS, TIPS, NEEDLE

Gun type	Aircap w/o ring		Part number	Tips		Needle for manual guns Part number
	Type	Air flow-rate		Fluid flow rate		
KMX 3	KX116 - fixed fan	2.9 cfm at 29 bar (5 Nm ³ /h at 2 bar)	132-284-100	see AIRMIX® tips	129-272-100	
	KX16 - adjustable fan	4.7 cfm at 29 psi (8 Nm ³ /h at 2 bar)	132-284-000			

AIRCAP RING

Description	Part number
Aircap ring for KMX/KAX	129-276-001

KMC 3

MANUAL ELECTROSTATIC GUNS



Ideal for complex parts such as tubes, frameworks, chassis and tables...

Compliant with ATEX Directive:
 INERIS 03 ATEX 0026X
 II 2 G
 EEX 0,24 mJ

To be used in zone 1



FEATURES	BENEFITS
Fewer components	Easy field repair
Wide range available	For a large range of materials
Built-in HT generator	Low voltage cable and user-friendly operation
Adjustable high voltage with integrated safety circuit	Adjustment of the electrostatic effect to the part to be painted and the fluid sprayed
Light and ergonomic	User friendly
Option: ventilated air double sleeve hose	Maximum wrap-around effect for materials with resistivity lower than 5 Mohms.cm
Comes in a case complete with gun wrench and screwdriver, gun cover, hose sleeve, laminated safety sheet, service manual, KX5 aircap and K30 nozzle	Ready to use gun/quick and simple maintenance



SPECIFICATIONS	
Maximum air inlet pressure	87 psi (6 bar)
Maximum fluid pressure	145 psi (10 bar)
Weight	w/o hose or cable 28.2 oz (800 g)
Flow rate	Depends on the tip used
Fan width	Upon tip and adjustable by aircap rotation
Total length	11.2 in (28.5 cm)
Recommended fluid viscosity	40 s CA4 maxi
Probe voltage	20 - 85 kV
Maximum current	100 µA
Maximum temperature	140°F (60°C)
Wetted parts	Stainless steel - Polyamide - PETP - PTFE - Polyacetal - Polyethylene

FITTINGS		
Fitting	Air	M 1/4" NPS
	Fitting (resistivity > 5Mohms.cm)	M #5 JIC
	Fitting (resistivity < 5Mohms.cm)	F #5 JIC



KMC 3  H2O GUN					
Description	Fan shape	Aircap	Tip	Voltage cable length	Part number
			Size (mm)		
KMC3  spray gun	Round hollow fan	KXC 5	K 30	32.8 ft (10 m)	135-283-430
KMC3  spray gun	Round hollow fan	KXC 5	K 30	49.2 ft (15 m)	135-283-435

KMC3  REPAIR KIT	
Description	Part number
KMC3  repair kit (cartridge, tip, needle, aircap and seals)	129-273-350

■ Aircaps, tips, needles for KMC 3

AIRCAPS, TIPS, NEEDLES AND MAINTENANCE KITS FOR KMC 3

Gun type	Aircap type	Air output	Part number	Tip Size	Fluid output	Part number	Needle for KAC Part number
KMC 3	KX55	4.7 cfm at 29 psi (8 Nm ³ /h at 2 bar)	132-400-100	K20	6.7 oz/mn (200 cm ³ /mn)	134-873-020	129-272-100
KMC 3	KX55		132-400-100	K30 (supplied with gun)	10.1 oz/mn (300 cm ³ /mn)	134-873-030	129-272-100
KMC 3	KX55		132-400-100	K40	13.5 oz/mn (400 cm ³ /mn)	134-873-040	129-272-100
KMC 3	KX55		132-400-100	K50	16.9 oz/mn (500 cm ³ /mn)	134-873-050	129-272-100
KMC 3	KX55		132-400-100	K60	20.3 oz/mn (600 cm ³ /mn)	134-873-060	129-272-100
KMC 3	KX55		132-400-100	K70	23.7 oz/mn (700 cm ³ /mn)	134-873-070	129-272-100

■ STD9 power supply for manual guns

The STD 9 compact power supply transforms main alternating current into a variable direct current adjustable between 3V and 12V. It is designed to be used with KMP 3, KMV 3, KMX 3 and KMC3 electrostatic spray guns.

It has a built-in electronic system to ensure the safe operation of the spray gun. A switch in the power supply turns the voltage on when the gun is triggered and atomization air is flowing.



STD9 POWER SUPPLY

Description	Part number
STD 9 power supply (manual guns)	148-200-150

■ Air and fluid hoses for K3 guns

FLUID AND AIR HOSES

Length	Air hose (F 1/4" NPS)		Product hose (F #5 JIC)		
	16.4 ft (5 m)	32.8 ft (10 m)	16.4 ft (5 m) (resistivity higher than 5 MΩ/cm)	32.8 ft (10 m) (resistivity higher than 5 MΩ/cm)	32.8 ft (10 m) insulating (resistivity lower than 5 MΩ/cm)
KMP	050-389-101	050-389-102	050-450-604	050-450-606	129-292-310
KMV	050-389-101	050-389-102	050-450-604	050-450-606	129-292-310
KMX	82-2725-16	82-2725-32	050-450-604	050-450-606	129-292-310
KMC	82-2725-16	82-2725-32	050-450-604	050-450-606	129-292-310



KMV 3 H2O

This gun is designed for water-based materials without built-in electronics and without electrical cable. This gun has to be used with a special hose for an optimal electrostatic effect.

Perfect for complex parts: tubular, frames, complex shapes, tables...



Model shown: KMP3 H2O

FEATURES	BENEFITS
Fewer components	Easy field repair
Built-in HT generator	Lightweight gun 21.8 oz versus 28.2 oz (620 g versus 800 g), no high voltage cable and user-friendly operation
Adjustable high voltage with integrated safety circuit	Adjustment of the electrostatic effect to the part to be painted and the fluid sprayed
Ergonomic	User friendly
Comes in a case complete with gun wrench and screwdriver, gun cover, hose sleeve, laminated safety sheet, service manual, aircap and KMV nozzle	Ready to use gun/quick and simple maintenance

SPECIFICATIONS	
Maximum air inlet pressure	87 psi (6 bar)
Maximum fluid pressure	145 psi (10 bar)
Weight	w/o hose or cable 21.8 oz (620 g)
Fluid flow rate	0.26 gal/mn (1 L/mn) max
Fan width	7.8 in (20 cm)
Total length	11.2 in (28.5 cm)
Recommended fluid viscosity	40 s CA4 maxi
Probe voltage	20 - 85 kV
Maximum current	100 µA
Maximum temperature	140°F (60°C)
Wetted parts	Stainless steel - Polyamide - PETP - PTFE - Polyacetal - Polyethylene

FITTINGS		
Fitting	Air	M 1/4" NPS
	Fitting (resistivity < 5Mohms.cm) - on double sleeve hose	F #5 JIC



KMV 3 H2O GUN CONFIGURATION				
Description	Fan shape	Aircap	Tip size	Part number
KMV3 H2O gun	Round	KMV	Swirling fan	135-297-000

Aircaps, tips, needles for KMV 3 H2O

AIRCAPS, TIPS AND NEEDLES FOR KMV 3 H2O						
Gun type	Aircap w/o ring		Tip size	Needle automatic guns		
	Type	Air flow-rate		Part number	Part number	Part number
KMV3 H2O	KMV	9.4 cfm at 58 psi (16 Nm³/h at 4 bar)	Swirling fan 33.8 oz/mn at 21.7 psi (1000 cm³/mn at 1.5 bar)	129-277-354	129-277-040	129-277-100

AIRCAP RINGS	
Description	Part number
Aircap ring for KMV/KAV	129-277-370



KMP 3 H2O

This gun is designed for water-based materials without built-in electronic and without electrical cable. This gun has to be used with a special hose for an optimal electrostatic effect. Perfect for all parts requiring high finish quality while maintaining excellent edge coverage: cabinets, industrial body shops, accessories....

FEATURES	BENEFITS
Fewer components	Easy field repair
Built-in HT generator	Lightweight gun 21.8 oz versus 28.2 oz (620 g versus 800 g), no high voltage cable and user-friendly operation
Adjustable high voltage with integrated safety circuit	Adjustment of the electrostatic effect to the part to be painted and the fluid sprayed
Ergonomic	User friendly
Comes in a case complete with gun wrench and screwdriver, gun cover, hose sleeve, laminated safety sheet, service manual, KP3 aircap and Ø1,2	Ready to use gun/quick and simple maintenance



SPECIFICATIONS	
Maximum air inlet pressure	87 psi (6 bar)
Maximum fluid pressure	145 psi (10 bar)
Weight	w/o hose or cable (g) 21.8 oz (620 g)
Fluid flow rate	(240 L/mn)
Fan width	11.8 in (30 cm)
Total length	11.2 in (28.5 cm)
Recommended fluid viscosity	40 s CA4
Probe voltage	20 - 85 kV
Maximum current	100 µA
Maximum temperature	140°F (60°C)
Wetted parts	Stainless steel - Polyamide - PETP - PTFE - Polyacetal - Polyethylene

FITTINGS		
Fitting	Air	M 1/4" NPS
	Fitting (resistivity < 5Mohms.cm) - on double sleeve hose	F #5 JIC



KMP3 H2O FLAT FAN CONFIGURATION				
Description	Fan shape	Aircap	Tip size	Part number
KMP3 H2O gun	Flat	KP3	0.472 in (1.2 mm)	135-296-000

■ Aircaps, tips, needles for KMP 3 H2O

TIPS, AIRCAPS AND NEEDLES FOR KMP3 H2O								
Gun type	Aircap w/o ring	Tip				Needle automatic guns		
		Type	Air flow-rate	Part number	Size (mm)	Fluid output	Part number	Part number
KMP3	KP3		14.1 cfm @ 58 psi (24 Nm³/h at 4 bar)	132-286-000	Ø 1.2 (supplied with gun)	20.29 oz/mn at 58 psi (600 cm³/mn at 4 bar)	129-276-205	129-276-100
KMP3	KP3		14.1 cfm @ 58 psi (24 Nm³/h at 4 bar)	132-286-000	Ø 1.5	27.05 oz/mn at 58 psi (800 cm³/mn at 4 bar)	129-276-220	129-276-100

AIRCAP RINGS	
Description	Part number
Aircap ring for KMV/KAV	129-277-370

KMX 3 H2O



This gun is designed for water-based materials without built-in electronic and without electrical cable. This gun has to be used with a special hose for an optimal electrostatic effect. Perfect for all parts requiring high finish quality while maintaining excellent edge coverage: cabinets, industrial body shops, accessories....

FEATURES	BENEFITS
Fewer components	Easy field repair
Built-in HT generator	Lightweight gun 21.8 oz versus 28.2 oz (620 g versus 800 g), no high voltage cable and user-friendly operation
Adjustable high voltage with integrated safety circuit	Adjustment of the electrostatic effect to the part to be painted and the fluid sprayed
Ergonomic	User friendly
Comes in a case complete with gun wrench and screwdriver, gun cover, hose sleeve, laminated safety sheet, service manual, KX16 aircap and 09,135 tip	Ready to use gun/quick and simple maintenance



SPECIFICATIONS	
Maximum air inlet pressure	87 psi (6 bar)
Maximum fluid pressure	145 psi (10 bar)
Weight	w/o hose or cable 21.8 oz (620 g)
Fluid output	Depends on the tip used
Fan width	Upon tip and adjustable at the aircap
Total length	11.2 in (28.5 cm)
Recommended fluid viscosity	40 s CA4 maxi
Probe voltage	20 - 85 kV
Maximum current	100 µA
Maximum temperature	140°F (60°C)
Wetted parts	Stainless steel - Polyamide - PETP -PTFE - Polyacetal - Polyethylene

FITTINGS		
Fitting	Air	M 1/4" NPS
	Fitting (resistivity < 5Mohms.cm) - on double sleeve hose	F #5 JIC



KMX3 H2O GUN CONFIGURATION				
Description	Fan shape	Aircap	Tip size	Part number
KMX3 H2O gun	adjustable flat fan	KX16	09-135	135-294-000

Aircaps, tips, needles for KMX 3 H2O

TIPS, AIRCAPS AND NEEDLES FOR KMX3 H2O					
Gun type	Type	Aircap w/o ring		Tips	
		Air flow-rate	Part number	Fluid flow rate	Needle for manual guns Part number
KMX 3	KX116 - fixed fan	2.9 cfm @ 29 psi (5 Nm ³ /h at 2 bar)	132-284-100	see AIRMIX® table	129-272-100
KMX 3	KX16 - adjustable fan	4.7 cfm @ 29 psi (8 Nm ³ /h at 2 bar)	132-284-000	see AIRMIX® table	129-272-100

AIRCAP RING	
Description	Part number
Aircap ring for KMX/KAX	129-276-001



■ Special tips with dielectric insert

SPECIAL TIPS												
Size ⁽¹⁾	Water output in oz/mn (L/mn)			Ø equivalent	Screen mark		number marked on the tip	Average width of fan at 25 cm				
	290 psi (20 bar)	507 psi (35 bar)	725 psi (50 bar)		gun filter	pump filter		13 cm	19 cm	23 cm	27 cm	35 cm
06	5.28 oz/mn (0.15 L/mn)	7.04 oz/mn (0.20 L/mn)	10.56 oz/mn (0.30 L/mn)	0.011 in (0.28 mm)	4	4 or 6	number marked on the tip	06-075	06-095	06-115	06-135	-
09	7.04 oz/mn (0.20 L/mn)	10.56 oz/mn (0.30 L/mn)	15.84 oz/mn (0.45 L/mn)	0.013 in (0.33 mm)	6	6 or 8	number marked on the tip	09-075	09-095	09-115	09-135	-
12	9.15 oz/mn (0.26 L/mn)	12.67 oz/mn (0.36 L/mn)	19.36 oz/mn (0.55 L/mn)	0.015 in (0.38 mm)	6	6 or 8	number marked on the tip	-	12-095	12-115	12-135	-
14	10.56 oz/mn (0.30 L/mn)	14.08 oz/mn (0.40 L/mn)	24.64 oz/mn (0.70 L/mn)	0.016 in (0.41 mm)	6	8 or 12	number marked on the tip	-	14-095	-	-	14-175

(1) To determine the part number of a tip, use the number listed in the table and replace the crosses in the following part number: 134-5xx-xxx



KMC 3 H2O

This gun is designed for water-based materials without built-in electronic and without electrical cable. This gun has to be used with a special hose for an optimal electrostatic effect. Perfect for large complex parts.

FEATURES	BENEFITS
Fewer components	Easy field repair
Built-in HT generator	Lightweight gun 21.8 oz versus 28.2 oz (620 g versus 800 g), no high voltage cable and user-friendly operation
Adjustable tension with integrated safety circuit	Adjustment of the electrostatic effect to the part to be painted and the fluid sprayed
Ergonomic	User friendly
Comes in a case complete with gun wrench and screwdriver, gun cover, hose sleeve, laminated safety sheet, service manual, KX5 aircap and K30 nozzle	Ready to use gun/quick and simple maintenance



SPECIFICATIONS	
Maximum air inlet pressure	87 psi (6 bar)
Maximum fluid pressure	145 psi (100 bar)
Weight	w/o hose or cable 21.8 oz (620 g)
Fluid output	Upon tips
Total length	11.2 in (28.5 cm)
Recommended fluid viscosity	40s CA 4 maxi
Probe voltage	20 - 85 kV
Maximum current	100 µA
Maximum temperature	140°F (60°C)
Wetted parts	Stainless steel - Polyamide - PETP - PTFE - Polyacetal - Polyethylene

FITTINGS		
Fitting	Air	M 1/4" NPS
	Fitting (resistivity < 5Mohms.cm) - on double sleeve hose	F #5 JIC



KMC3 H2O HOLLOW FAN GUN CONFIGURATION				
Description	Fan shape	Aircap	Tip	Part number
			Size (mm)	
KMC3 H2O gun	Round hollow fan	KXC5	K30	135-293-000

KMC 3 H2O MAINTENANCE KIT	
Description	Part number
KMC3 🛠️ repair kit (cartridge, tip, needle, aircap and seals)	129-273-350

Aircaps, tips, needles KMC 3 H2O

AIRCAPS, TIPS, NEEDLES FOR KMC 3							
Gun type	Aircap type	Aircap Air consumption (CFM)	Part number	Tip	Fluid output	Part number	Needle for KAC
				Size			Part number
KMC	KX55	4.7 cfm at 29 psi (8 Nm³/h at 2 bar)	132-400-100	K20	6.8 oz/mn (200 cm³/mn)	134-873-020	129-272-100
				K30 (supplied with gun)	10.1 oz/mn (300 cm³/mn)	134-873-030	129-272-100
				K40	13.5 oz/mn (400 cm³/mn)	134-873-040	129-272-100
				K50	16.9 oz/mn (500 cm³/mn)	134-873-050	129-272-100
				K60	20.3 oz/mn (600 cm³/mn)	134-873-060	129-272-100
				K70	23.7 oz/mn (700 cm³/mn)	134-873-070	129-272-100



ISO BUBBLE II

For water-based paints, the pump and paint should be isolated in an ISO Bubble.

The ISO Bubble II, with a compact design, can be installed near the working area.

With a large sliding cover, it allows for fast and easy pressure adjustments and color changes. A built-in safety device ensures the system is grounded when the gun is not triggered or if the cover is opened.



Pump not supplied

FEATURES	BENEFITS
Wide dimensions	Compatible with a large range of pumps: PMP 150, 02.75, 15-C25, 20.25, 20.50, 17.A2
New grounding system	For maximum safety
New connection	For a quick service and maintenance

SPECIFICATIONS	
Material	White polyethylene
Total height	57.2 in (145-3 cm)
External diameter (bottom/top)	28.3 /27.6 in (72/70 cm)
Internal height	39.4 in (100 cm)
Internal diameter	26.7 in (68 cm)
Weight	66 lbs (30 kg)
Maximum air inlet pressure	87 psi (6 bar)

ISOBUBBLE II PART NUMBERS				
Description	Recommended hoses	Hose length	Barrel	Part number
ISO Bubble II	Non conductive air hoses	16.4 ft (5 m)	-	148-260-000
		16.4 ft (5 m)	Yes (for mounting with H2O gun or automatic guns)	148-260-100

ISO BUBBLE II PART NUMBERS	
Description	Part number
System, Electro, ISO Bubble II c/w 17.A2, KMX H2O	668-730-250
System, Electro, ISO Bubble II c/w PMP-150 KMP H2O	668-753-100
System, Electro, ISO Bubble II c/w 02-75,KMP H2O	668-761-100



■ STD9 B power supply for H2O manual guns

The STD 9 B compact power supply transforms main alternating current into a variable direct current adjustable between 3V and 8V. It has to be used with KMP 3 H2O, KMV 3 H2O, KMX 3 H2O and KMC 3 H2O electrostatic spray guns.

It has a built-in electronic system to ensure the safe operation of the spray gun. A switch in the power supply turns the voltage on when the gun is triggered and atomization air is flowing.



STD9 POWER SUPPLY

Description	Part number
STD 9B power supply - specific for ISO Bubble II™	148-200-200

■ Feeding hoses for H2O guns

The special hose allows for an optimum electrostatic effect by preventing any condensation.

ADAPTATION FITTING

Description	Part number
Adaptor F 3/8" NPS/M#5 JIC	050-123-306

FEEDING HOSES FOR H2O GUN

	50 ft (15 m) length	32 ft (10 m) length.
Fluid hose for H2O gun	129-292-315	129-292-310
Air hose - Ø 7 (KMX H2O, KMC H2O)	82-2725-50	82-2725-32
Air hose - Ø8 (KMP H2O, KMV H2O)	050-389-105	050-389-102



New generation of automatic electrostatic guns with swirling fan for maximum wrap-around effect on complex parts. High quality adjustable flat fan.

Compliant with ATEX Directive:
 INERIS 04 ATEX 0093X
 II 2 G
 EEx 0,24 mJ

To be used in zone 1



FEATURES	BENEFITS
Fewer components	Easy field repair
New generator barrel with 3 positions indexing (-45°, 0, + 45°)	Guaranteed positioning on robot mounting
Generator barrel close to the gun	No high voltage cable and user-friendly operation
Adjustable high voltage with integrated safety circuit	Adjustment of the electrostatic effect to the part to be painted and the fluid sprayed
Aircaps and nozzle	Quick maintenance and stock reduction



SPECIFICATIONS	
Maximum fluid pressure	1740 psi (120 bar)
Trigger air pressure (minimum)	58 ps i(4 bar)
Recommended atomization air pressure	87 psi (6 bar)
Weight	without hoses, cable 38.8 oz (1100 g) with BG barrel
Fluid output	Upon tip
Fan width	Ajustable at the aircap
Total length	(340 cm)
Recommended fluid viscosity	40s CA4 max.
Probe voltage	85 kV max
Maximum current	100 µA
Maximum temperature	140°F (60°C)
Wetted parts	Polyacetal, stainless steel, carbide

FITTINGS		
Fitting	Air	Spraying (polyamide 6x8), pilot (polyamide 4x6)
	Fitting (resistivity > 5Mohms.cm)	#5 JIC
	Fitting (resistivity < 5Mohms.cm)	F 1/2 JIC



KAX  GUN				
Description	Supplied with aircap	Tip	Voltage cable length	Part number
KAX  with generator barrel	KX16	To be ordered separately in the di-electric inser tip table	39.4 ft (12 m)	135-397-720
KAX  without generator barrel	KX16	To be ordered separately in the di-electric inser tip table	-	129-397-200

PART NUMBERS	
Description	Part number
KAX  package c/w accessories	668-397-720

■ Aircaps, tips, needles for KAX

AIRCAPS, TIPS, NEEDLE						
Gun type	Aircap w/o ring		Part number	Tips		Needle for manual guns Part number
	Type	Air flow-rate		Fluid flow rate		
KAX 3	KX116 - fixed fan	5 Nm ³ /h at 2 bar	132-284-100	See AIRMIX® tips table		129-397-211
KAX 3	KX16 - adjustable fan	8 Nm ³ /h at 2 bar	132-284-000	See AIRMIX® tips table		129-397-211

AIRCAP RING	
Description	Part number
Aircap ring for KMX/KAX	129-276-001

■ Special tips with dielectric insert



SPECIAL TIPS												
Size ⁽¹⁾	Water output in oz/mn (L/mn)			Ø equivalent	Screen mark			Average width of fan at 25 cm				
	290 psi (20 bar)	507 psi (35 bar)	725 psi (50 bar)		gun filter	pump filter		13 cm	19 cm	23 cm	27 cm	35 cm
06	5.28 oz/mn (0.15 L/mn)	7.04 oz/mn (0.20 L/mn)	10.56 oz/mn (0.30 L/mn)	0.011 in (0.28 mm)	4	4 or 6	number marked on the tip	06-075	06-095	06-115	06-135	-
09	7.04 oz/mn (0.20 L/mn)	10.56 oz/mn (0.30 L/mn)	15.84 oz/mn (0.45 L/mn)	0.013 in (0.33 mm)	6	6 or 8	number marked on the tip	09-075	09-095	09-115	09-135	-
12	9.15 oz/mn (0.26 L/mn)	12.67 oz/mn (0.36 L/mn)	19.36 oz/mn (0.55 L/mn)	0.015 in (0.38 mm)	6	6 or 8	number marked on the tip	-	12-095	12-115	12-135	-
14	10.56 oz/mn (0.30 L/mn)	14.08 oz/mn (0.40 L/mn)	24.64 oz/mn (0.70 L/mn)	0.016 in (0.41 mm)	6	8 or 12	number marked on the tip	-	14-095	-	-	14-175

(1) To determine the part number of a tip, use the number listed in the table and replace the crosses in the following part number: 134-5xx.xxx

■ STD9 A power supply for automatic guns

The STD 9 A compact power supply transforms main alternating current into a variable direct current adjustable between 3V and 12V. It has to be used with the KAP 3, KAV 3, KAX 3 and KAC 3 electrostatic spray guns

It has a built-in electronic system to ensure the safe operation of the spray gun.

A switch in the power supply turns the voltage on when the gun is triggered and atomization air is flowing.



STD9 POWER SUPPLY	
Description	Part number
STD 9 A power supply - specific for automatic guns	148-200-450

■ Generator barrel, special HT cable

All automatic electrostatic guns must be fitted on a generator bar connected to an STD 9 power supply.

GENERATOR BARREL		
Description	Length	Part number
Generator barrel with 39.4 ft (12 m) electrical cable - for mounting with automatic guns	39.4 ft (12 m)	129-397-600
Generator barrel with 19.7 ft (6 m) electrical cable - for mounting with ISO Bubble	19.7 ft (6 m)	129-397-650
HV cable for an automatic gun remote mounting	4.9 ft (1.5 m)	129-397-800
Mounting assembly for generator barrel for Reciprocator	-	060-522-080
Fixed gun support (5/8" Ø16)	-	129-391-030



■ Conversion kits

Whatever the gun type is (KMP, KMV, KMX, KMC), it is possible to switch to another version (for example from KMC to KMX) by choosing the appropriate conversion kit.

Tip	Supplied with aircap	Kit Description	Part number
1.2	KP3	Conversion in KMP 3	129-286-300
Vortex fan	KMV	Conversion in KMV 3	129-287-300
09-135	KX 16	Conversion in KMX 3	129-284-300
K 30	KXC5	Conversion in KMC 3	129-283-300

■ AP 1000 Resistivity gauge

Comes complete with probe

PART NUMBER	
Description	Part number
AP 1000 high precision resistivity gauge	910005790



■ Spray gun cover

Essential during spraying, the cover offers total protection for the spray gun

SPRAY GUN COVER		
Description	Quantity	Part number
Pack of covers	10	129-270-095



■ Hose sleeve

This sleeve protects the hoses and the cables, guaranteeing longer life and flexibility

PART NUMBER			
Description	Product hole	Length	Part number
Hose sleeve	1.6 in (40 mm)	32 ft (10 m)	669-990-103

■ In-line paint filter

With its compact dimensions, it fits on base of the handle or between two hoses (for AIRMIX® version with hoses 1m + 10m)

FILTERS					
Description	Set-up	Maximum fluid pressure (bar)	Thread		Part number
			Inlet	Outlet	
Stainless steel filters supplied with 6 screen - 168µ	Between 2 hoses	2900 psi (200 bar)	M 1/2 JIC	M 1/2 JIC	155-010-000
	At the gun Fluid inlet		M 1/2 JIC	F 1/2 JIC	155-010-100

FILTER SCREEN					
Description	Filter number	Filtration size		Nozzle size	Part number
		Micron	Mesh		
Filter screen (pack of 5)	4	99	140	4	129-609-907
Screen number 12 (x5)	6	168	85	6	129-609-908
Screen number 12 (x5)	12	280	55	20	129-609-909

PLURAL COMPONENT PUMPS AND MACHINES



PU 2125 F PUMP

MECHANICAL MIXING



Low pressure applications

The PU 2125 F pump is a fixed ratio two-component pump for low pressure applications, such as conventional or HVLP spray guns.

The proportioning pump is mounted on a cart and consists of :

- Two component metering pump assembly
- Static mixer
- MATERIAL/SOLVENT selection assembly
- Suction rod and a drain rod for the BASE
- Suction rod for the solvent
- Gravity container and a hose for the CATALYST

FEATURES	BENEFITS
Sealing done by a Flowmax® Bellows on the catalyst side	High reliability No more lubricant cups Leak free Total sealing between pump and its environment Ideal to work with moisture-sensitive catalysts Ideal for UV and pre-catalyzed materials
Comes with mixer, mix manifold, dual air controls, 5 gal (20 L) suction rod for base and flushing solvent, 1.5 gal (6 L) catalyst gravity tank	Ready to use pump
Semi-automatic manifold	Safe operation User-friendly
Catalyst re-circulation during color changes	Quick color change and flushing without catalyst loss
Stainless steel fluid sections (base and catalyst) is standard	Chemical compatibility w/o any risk of corrosion with water-based materials
Cart-mounted pump	Easy portability

SPECIFICATIONS	
Mixing ratio (upon version)	1:1 - 2:1 - 3:1 - 4:1 - 5:1
Pressure ratio	varies with ratio
Max fluid viscosity in CA 4	180 s
Maximum air inlet pressure	87 psi (6 bar)
Sound level	80 dBA
Weight	110 lbs (50 kg)
Wetted parts	Stainless steel, polyethylene, treated steel Catalyst fluid section: 304 stainless steel Bellows: PTFE

DOSING RATIO					
Description	Volume dosing ratio	Fluid output at 20 Cycles/mn	Pressure ratio	Fluid pressure (upon air motor pressure)	
				58 psi (4 bar)	87 psi (6 bar)
PU 2125 F 1:1	1:1	0.9 gal/mn (3.5 L/mn)	0.9:1	52 (3.6)	78.3 (5.4)
PU 2125 F 2:1	2:1	0.69 gal/mn (2.6 L/mn)	1.2:1	69.6 (4.8)	104.4 (7.2)
PU 2125 F 3:1	3:1	0.61 gal/mn (2.4 L/mn)	1.4:1	81.2 (5.6)	121.8 (8.4)
PU 2125 F 4:1	4:1	0.56 gal/mn (2.2 L/mn)	1.5:1	87 (6)	130.5 (9)
PU 2125 F 5:1	5:1	0.54 gal/mn (2.1 L/mn)	1.6:1	92.8 (6.4)	139.2 (9.6)

PU 2125F PART NUMBERS	
Description	Part number
PU 2125 F pump cart-mounted - dosing ratio 1:1	151-586-100
PU 2125 F pump cart-mounted - dosing ratio 2:1	151-586-110
PU 2125 F pump cart-mounted - dosing ratio 3:1	151-586-120
PU 2125 F pump cart-mounted - dosing ratio 4:1	151-586-130
PU 2125 F pump cart-mounted - dosing ratio 5:1	151-586-140



FITTINGS	
Air inlet (valve)	F 3/8" BSP
Air outlet (atomization air)	M 1/4" NPS
Fluid outlet	M #5 JIC



PU 2160 F PUMP

Airmix® pressure applications.

The PU 2160 F fixed ratio pump is used for applying two component material with one Airmix® gun.

The PU 2160 F is a complete two component metering and mixing system designed to provide small and medium shops the ability to spray two component coatings at Airmix® pressures.

The proportioning pump is mounted on a cart and composed of :

- Two component metering pump assembly
- Static mixer
- PRODUCT/SOLVENT selection assembly
- Suction rod and a drain rod for BASE
- Suction rod for the solvent
- Gravity container and a hose for CATALYST



FEATURES	BENEFITS
Sealing done by a FLOWMAX® Bellows on the catalyst side	High reliability No more lubricant cups Leak free Total sealing between pump and its environment Ideal to work with moisture-sensitive catalysts Ideal for UV and pre-catalyzed materials
Comes with 5 gal (20 L) metering pumps, mix manifold, air feeding assembly, suction rod for base and flushing solvent, 1.5 gal (6 L) catalyst gravity tank	Ready to use system directly out of 5 gallon pails
Semi-automatic manifold	Safe operation User-friendly
Catalyst re-circulation	Quick color change and flushing without catalyst loss
Stainless steel fluid sections (base and catalyst) - in standard	Chemical compatibility w/o any risk of corrosion with water-based materials
Cart-mounted pump	Easy portability
PH compatible 316 stainless steel catalyst circuit on 10:1 pressure ratio version	Ideal for chemically aggressive catalysts

SPECIFICATIONS	
Mixing ratio (upon version)	1:1 - 2:1 - 5:1 - 10:1
Pressure ratio	10:1- 15:1 - 18:1 - 20:1
Max fluid viscosity in CA 4	180 s
Maximum air inlet pressure	87 psi (6 bar)
Sound level	80 dBA
Weight	132 lbs (60 kg)
Wetted parts	Stainless steel, polyethylene, PTFE, nickel-coated steel Catalyst fluid section 1:1, 2:1 and 5:1 304 stainless steel, 10:1: 316L stainless steel

DOSING RATIO					
Description	Volume dosing ratio	Fluid output at 20 Cycles/mn	Pressure ratio	Fluid pressure (upon air motor pressure)	
				58 psi (4 bar)	87 psi (6 bar)
PU 2160 F 1:1	1:1	0.21 gal/mn (0.8 L/mn)	10:1	580 psi (40 bar)	870 psi (60 bar)
PU 2160 F 2:1	2:1	0.16 gal/mn (0.6 L/mn)	15:1	870 psi (60 bar)	1305 psi (90 bar)
PU 2160 F 5:1	5:1	0.13 gal/mn (0.5 L/mn)	18:1	1044 psi (72 bar)	1566 psi (108 bar)
PU 2160 F 10:1	10:1	0.12 gal/mn (0.44 L/mn)	20:1	1160 psi (80 bar)	1740 psi (120 bar)

FITTINGS	
Air inlet (valve)	F 3/8" BSP
Air outlet (atomization air)	M 1/4" NPS
Fluid outlet	M #5 JIC

PU 2160F PART NUMBERS		
Description		Part number
PU 2160 F pump, cart mount, pressure ratio 1:1		151-586-690
PU 2160 F pump, cart mount, pressure ratio 2:1		151-586-695
PU 2160 F pump, cart mount, pressure ratio 5:1		151-586-710
PU 2160 F pump, cart mount, pressure ratio 10:1		151-586-700

PU 2160F KIT PART NUMBERS		
Kit Description		Part number
System, PU 2160 F, 1:1, C/w Xcite™, 25 ft hose		668-586-011
System, PU 2160 F, 2:1, C/w Xcite™, 25 ft hose		668-586-021
System, PU 2160 F, 5:1, C/w Xcite™, 25 ft hose		668-586-051
System, PU 2160 F, 10:1, C/w Xcite™, 25 ft hose		668-586-101

PU 3000 - ELECTRO MECHANICAL

ELECTRONIC DOSING



The PU 3000 is an innovative, economical and patent pending solution that combines electronic control and mechanical metering. The PU 3000 is easy to operate and easy to install. The control box is user friendly and allows the operator to intuitively learn how to operate the machine.

Pulse-Free Electronic (PFE) relates to the control of pump change over and the elimination of material pulsation during pump change over. The PFE features a constant output and a +/- 1% metering accuracy for an outstanding finish. Electronic dosing constantly monitors the actual material consumption of products and calculates the VOC's. The machine can be installed in the spray zone to be in close proximity to the operator.

The operator controls must be located in a safe environment.

The PU 3000 is available in low pressure, AIRMIX® and airless versions to meet most market requirements.

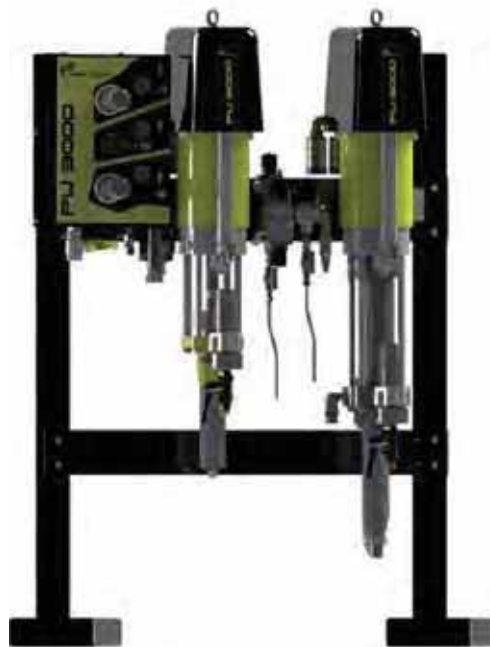

FEATURES	BENEFITS
Plug & Spray	Quick start-up
KREMLIN REXSON patent: Pulse-Free Electronic Control (PFE) Innovative control system of pump change-over	Constant fluid flow rate Unsurpassed +/- 1% mixing accuracy and +/- 1% repeatability
Direct injection in the high performance static mixer	Precise mixing
Recording of fluid consumptions and VOC's	Fluid and solvent consumptions stored in memory Easy access & clearable
Component management: base, catalyst and solvent	User friendly
Flushing and material regeneration User-friendly control panel	User-friendly and easy programming for the operator
Preventive maintenance alarm Continuous ratio checking and alarm Low level drum alarm	Self monitoring
Ratio check kit is standard with 2 liter test tube Filter and drain assembly is standard	Visual verification of mixing accuracy No product loss
Sealing done by a FLOWMAX® Bellows on the catalyst side for Airspray and AIRMIX® versions	High reliability Total sealing between pump and its environment, ideal to work with moisture-sensitive catalysts
Wide variable range of ratio from 5 to 160% Suitable for HTi / HPA / HTV, AIRMIX®, AIRLESS spraying technologies Very low flow rate from 10cc	Suitable for use on a wide range of markets
System is complete out of the box	Quick easy installation & start up. No engineering required



SPECIFICATIONS	
Electrical Power	115/230V - 75W
Maximum air inlet pressure	87 psi (6 bar)
Fluid viscosity	30 - 8000 cps (20,000 cps AIRLESS)
Mixing accuracy	+/- 1%
Mixed fluid output volume	10 - 2000 cc/min @ 1:1 (Check manual for other ratios) 10 - 4000 cc/min @ 1:1 (Check manual for other ratios)
Mixing ratio	1:1 - 53:1
Wetted parts	Stainless Steel and PEHD (316 SS on PH versions)
Weight	143 lbs (65 kg)
Dimensions	54x25x19 in (138x64x48cm)



PU 3000 - ELECTRO MECHANICAL

TECHNICAL CHARACTERISTICS

Description	Pressure ratio	Maximum fluid pressure
PU 3000 - HTi, HPA, HTV versions	1:1 - 7:1	87 - 580 psi (6 - 40 bar)
PU 3000 - AIRMIX® version	30:1	2900 psi (200 bar)
PU 3000 - AIRLESS version	53:1	5075 psi (350 bar)

PU 3000 DIMENSIONS

Description	Height	Depth	Width
HTi, HPA, HTV versions	51.8 in (130 cm)	27.2 in (69 cm)	33.8 in (86 cm)
AIRMIX® version	51.8 in (130 cm)	27.2 in (69 cm)	33.8 in (86 cm)
AIRLESS version	57.1 in (145 cm)	27.2 in (69 cm)	37.8 in (96 cm)
Control Box	11.25 in (28.6 cm)	5.7 in (14.3 cm)	5.7 in (14.4 cm)

FITTING

Fitting	Air inlet (valve)	F 3/4" BSP
	Air Outlet	F 1/4" BSP
	Fluid outlet	F 3/4 JIC

PU 3000 KIT PART NUMBERS

Kit Description	Part number
PU 3000 - Airless	668-681-100
PU 3000 - Airless 53:1 227 cc	668-681-400
PU 3000 - Airless 30:1 225 cc	668-681-500
PU 3000 - Airmix®, 50 Base / 50F CAT	668-681-200
PU 3000 - Airmix®, 50F Base / 50F CAT	668-681-250
PU 3000 - Airmix®, 50 Base / 50 CAT	668-681-251
PU 3000 - Airmix®, 50 Base / 50FPH CAT	668-682-200
PU 3000 - Airspray, 50 Base / 50F CAT	668-681-300
PU 3000 - Airspray, 50 FT Cable, NA version	668-681-350
PU 3000 - Airspray, 50 Base / 50FPH CAT	668-682-300

PU 3000 OPTIONS PART NUMBERS

Description	Part number
Spray booth glass mounting kit	155-660-340
Flushing pump	Depends on fluid ratio

CYCLOMIX™ MICRO AND MICRO+ PH

ELECTRONIC DOSING



The Cyclomix™ Micro machine parameters are easily set-up to suit almost any application. Operator training is in simple and easy steps that allows for quick start-up and operation. **Cyclomix™ Micro PH versions are also available for acid catalyzed coatings.**

FEATURES	BENEFITS
Automatic component management: base, catalyst and solvent	Dosing +/- 1% and repeatability +/- 0.5%
Automatic flushing and material generation	Quick start-up. Minimal material and solvent wastage.
Adjustable flushing volume Several flushing sequences available: only Base side; Base side then Catalyst; Catalyst side then Base side	Solvent savings and environmental protection
Operating pressure from 29 - 2500 psi (2 to 175 bar)	Allows to choose: low pressure and AIRMIX® spray technologies
Continuous ratio checking and off ratio alarm	The paint applied on parts always conforms to paint supplier specifications
User-friendly control panel	User-friendly and easy programming for the operator
Stainless steel construction	To handle a wide range of materials
Recording of fluid consumptions and VOC with the possibility to print records (with RS232 option)	Fluid and solvent consumptions stored in memory
Possibility to monitor the Cyclomix™ Micro from the spray booth (with the glass kit option)	Operator can control system while in spray booth
Design of the mix manifold	Easy maintenance and spare parts standardization

SPECIFICATIONS	
Electrical power	115 / 230V - 75W
Minimum operating air pressure	58 psi (4 bar)
Product pressure	29 - 2,500 psi (2 -175 bar)
Weight	55 lbs (25 kg)
Wetted parts	Stainless steel and HDPE 316L stainless steel on PH version catalyst side
Mixing ratio	Single component and 0.6:1 to 20:1
Mixing accuracy	1%
Mixed fluid output	3.4 - 67.6 oz/mn (100 - 2000 cm³/mn)
Fluid viscosity	30 - 5000 cps
Height	6.8 in (17.3 cm) (command cabinet) - 15.7 in (40 cm) (dosing unit)
Width	14.4 in (36.6 cm) (command cabinet) - 16 in (40.7 cm) (dosing unit)
Depth	4.4 in (11.1 cm) (command cabinet) - 11.8 cm (30 cm) (dosing unit)



FITTINGS	
Description	Fitting
Air supply	F 1/4" BSP
Air outlet	F 1/4" BSP
Fluid supply	M #5 JIC
Fluid outlet	M #5 JIC

CYCLOMIX™ MICRO AND MICRO+ PART NUMBERS

Description	Part number - USA	Part number - Canada (CSA)
CYCLOMIX™ Micro PH, 1+1, catalyst flush	997-108-000	668-661-951
CYCLOMIX™ Micro PH, 3+1, catalyst flush	997-108-100	668-661-953
CYCLOMIX™ Micro, 1+1	155-660-900	668-661-900
CYCLOMIX™ Micro, 1+1, catalyst flush	155-660-911	668-661-911
CYCLOMIX™ Micro, 3+1	155-660-930	668-661-930
CYCLOMIX™ Micro, 3+1, catalyst flush	155-660-933	668-661-933

CYCLOMIX™ MICRO AND MICRO+ PART NUMBERS

Description	Catalyst fluid passage flushing	Number of bases	Number of catalysts	Part number
CYCLOMIX™ Micro, 1+1	-	1	1	155-660-900
CYCLOMIX™ Micro, 3+1	-	3	1	155-660-930
CYCLOMIX™ Micro, 1+1, catalyst flush	●	1	1	155-660-911
CYCLOMIX™ Micro, 3+1, catalyst flush	●	3	1	155-660-933
CYCLOMIX™ Micro PH, 1+1, catalyst flush	●	1	1	997-108-000
CYCLOMIX™ Micro PH, 3+1, catalyst flush	●	3	1	997-108-100

OPTIONS FOR CYCLOMIX™ MICRO AND MICRO+

Description	Part number
Mixing assembly for Cyclomix® Micro+ PH	155-660-955
RS232 connection kit for printer	155-660-935
Spray booth glass mounting kit	155-660-340
7m extension cable between control cabinet and mixing panel	901-250-216

CYCLOMIX™ MULTI AND MULTI PH

ELECTRONIC DOSING



The Cyclomix™ MULTI system was designed for production shops that require accurate mixing and a small number of color changes. This system provides easy control and outstanding performance in one package. The Cyclomix™ MULTI system is also available in a PH version for acid catalyzed coatings.

FEATURES	BENEFITS
Adaptable programming for each color	Allows for flexibility with each coating recipe
Pneumatic emergency flush	Provides a complete system flush in case of power failure.
System interface	Connects easily to automated systems for triggering and flushing
Separate control box from the mixing unit	Allows for Class 1 Division 1 rating so the mixing unit can be located inside the booth
Multiple flushing sequences available	Provides flexibility for shift changes and shutdowns while saving material and solvent

SPECIFICATIONS	
Electrical power	115 / 230 V - 75 W
Trigger air pressure (mini)	58 psi (4 bar)
Product pressure	29 - 2900 psi (2 - 200 bar)
Weight	154 lbs (70 kg)
Wetted parts	Stainless steel and HDPE
Mixing ratio	0.6:1 to 20:1 (166.6% to 5%)
Mixing accuracy	+/- 1%
Solvent flow rate (m³/h)	3.38 - 67.6 oz/mn (100 - 2000 cm³/mn)
Mixed fluid output	3.38 - 67.6 oz/mn (100 - 2000 cm³/mn)
Fluid viscosity	30 - 5000 cps
Height	23.6 in (60 cm) control cabinet - 30.3 in (77 cm) mixing unit
Width	23.6 in (60 cm) control cabinet - 23.6 in (60 cm) mixing unit
Depth	15.7 in (40 cm) control cabinet - 30.3 in (77 cm) mixing unit

FITTINGS	
Description	Fitting
Air supply	F 1/4" BSP
Air outlet	F 1/4" BSP
Fluid supply	M #5 JIC
Fluid outlet	F 1/4" BSP



CYCLOMIX™ MULTI PH PART NUMBERS

Description	Number of bases	Number of catalysts	Part number
CYCLOMIX™ Multi PH, 3+2	3	2	668-660-423
CYCLOMIX™ Multi PH, 3+3	3	3	668-660-433
CYCLOMIX™ Multi PH, 5+1	5	1	668-660-415
CYCLOMIX™ Multi PH, 5+2	5	2	668-660-425
CYCLOMIX™ Multi PH, 7+1	7	1	668-660-417
CYCLOMIX™ Multi PH, 3+1	3	1	155-660-513
CYCLOMIX™ Multi PH, 5+1	5	1	155-660-515
CYCLOMIX™ Multi PH, 7+1	7	1	155-660-517

CYCLOMIX™ MULTI PART NUMBERS

Description	Number of bases	Number of catalysts	Part number
CYCLOMIX™ Multi, 3+1	3	1	155-660-813
CYCLOMIX™ Multi, 5+1	5	1	155-660-815
CYCLOMIX™ Multi, 7+1	7	1	155-660-817
CYCLOMIX™ Multi, 3+2	3	2	155-660-823
CYCLOMIX™ Multi, 5+2	5	2	155-660-825
CYCLOMIX™ Multi, 3+3	3	3	155-660-833

OPTION PART NUMBER CYCLOMIX MULTI

Description	Part number
Autowash	155-660-300

CYCLOMIX™ EXPERT

ELECTRONIC DOSING



The Cyclomix™ Expert is an innovative, industrial solution that is configured to meet the needs of the customer. This new innovative product can be upgraded over time while still delivering excellent product quality.

The Cyclomix™ Expert is available in Airspray, Airmix®, and Airless (up to 200 bar) configurations to meet the needs of our customers.

FEATURES	BENEFITS
Automatic component management up to 24 products in 1K, 2K or 3K mode of operation	Innumerable possibilities Flexibility when changing materials
Real time display of instant real ratio and flow rate	Continuous process control
No pre-mixing chamber : optimized fluid passages w/o retention zones	Perfect flushing Reduced fluid waste
All stainless steel construction	Compatible with water-based materials

SPECIFICATIONS	
Fluid pressure	Min 29 psi (2 bar) - Max 2900 psi (200 bar)
Compressed air	Min 50.7 psi (3.5 bar) - Max 87 psi (6 bar)
Voltage	115V / 230V - 75W
Frequency	50 - 60 Hz
Ratio percentage	A to B min/max 0.6:1 to 20:1 - 166% to 5%
Ratio tolerance	1%
Particle size	Max 5 micron
Noise level (at 1m)	70 dB A (depending upon Norm ISO 3746)
Viscosity range	min/max 30 to 5000 cps
Moisture (compressed air)	Max 10 ppm

COMPONENTS	
Number of products	Max 24
Number of A components	Min/Max 1 to 22 (total 24)
Number of B components	Min/Max 1 to 22 (total 24)
Number of C components	Min/Max 1
Number of A component solvents	Min/Max 1 to 22 (total 24)
Number of b component solvents	Min/Max 1 to 21 (total 24)
Material compatibility	Solvent and water-based paints

WEIGHT AND DIMENSIONS		
2K Version	105 lbs (48 kg)	39.4 x 34 x 7.8 in (100 x 86 x 20 cm)
3K Version	145 lbs (66 kg)	47.2 x 38 x 7.8 in (120 x 96 x 20 cm)
Control Panel	75 lbs (34 kg)	23.6 x 23.6 x 8.8 in (60 x 60 x 23 cm)

AVAILABLE CONFIGURATIONS

Call for more information



PH version
available for acid catalyzed coating

NOTE: The electrical construction of the panel is UL compliant for North America



CYCLOMIX™ EXPERT

SPECIFICATIONS

Voltage (V)	115 - 230
Number of fluid inlets	24
Trigger air pressure (mini)	58 psi (4 bar)
Operating pressure	72 - 2900 psi (5 - 200 bar)
Mixing ratio (in standard)	0.6:1 to 30:1
Mixing accuracy	+/- 1%
Mixed fluid output	1.7 - 203 oz/mn (50 - 6000 cm ³ /mn)
Fluid viscosity	30 - 5000 cps
Wetted parts	Stainless steel and HDPE (option 316L)
Width	39.4 in (100 cm) 3K - 35 in (89 cm)
Height	46.8 in (119 cm) 3K - 35.8 in (91 cm)
Weight	18.9 in (48 cm) 2K - 26.7 in (68 cm)

CONTROL BOX CHARACTERISTICS

Width	23.6 in (60 cm)
Height	23.6 in (60 cm)
Depth	15.7 in (40 cm)
Weight	55 lbs (25 kg)

CYCLOMIX™ EXPERT PART NUMBER

Description	Part number
CYCLOMIX™ Expert	Please consult us



FITTINGS AND AIR TREATMENT



■ Male to male connection Pmax: 290 PSI (20 BAR)

Max Pressure: 290 psi (20 bar)

METRICAL FITTINGS - 290 PSI (20 BAR)		
Male/Male	M 14 x 125	M 18 x 125
M 14 x 125		050-102-133 050-102-142 ⁽¹⁾
M 18 x 125	050-102-133 050-102-142 ⁽¹⁾	050-102-102



METRICAL ADAPTORS TOWARDS BSP - 290 PSI (20 BAR)				
Male/Male	M 14 x 125	M 18 x 125	M 26 x 125	M 38 x 150
G 1/8" (BSP) (5 x 10)	050-102-412			
G 1/4" (BSP) (8 x 13)	050-102-405 050-102-441 ⁽¹⁾	050-102-408 050-102-444 ⁽¹⁾		
G 3/8" (BSP) (12 x 17)	050-102-410	050-102-411 050-102-436 ⁽¹⁾		
G 1/2" (BSP) (15 x 21)	050-102-513	050-102-406 050-102-418 ⁽¹⁾	050-102-402 050-102-437 ⁽¹⁾	
G 3/4" (BSP) (20 x 27)		050-102-429	050-102-407	
G 1" (BSP) (26 x 34)				050-102-433

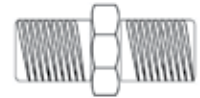

METRICAL ADAPTORS TOWARDS NPT - 290 PSI (20 BAR)	
Male/Male	M 26 x 125
1/2" NPT	050-102-507

(1) Stainless steel fittings

■ Male to male connection Pmax: 870 PSI (60 BAR)

FITTINGS BSP (GAZ) - 870 PSI (60 BAR)					
Male/Male	G 1/8" (5 × 10)	G 1/4" (8 × 13)	G 3/8" (12 × 17)	G 1/2" (15 × 21)	G 3/4" (20 × 27)
G 1/8" (5 × 10)		906-314-207 ⁽¹⁾			
G 1/4" (8 × 13)	906-314-207 ⁽¹⁾	050-102-213 906-314-203 ⁽¹⁾	904-523-003 906-314-204 ⁽¹⁾	050-102-211	
G 3/8" (12 × 17)		904-523-003 906-314-204 ⁽¹⁾	050-102-214 906-314-202 ⁽¹⁾	904-523-006 906-314-205 ⁽¹⁾	
G 1/2" (15 × 21)		050-102-211	904-523-006 906-314-205 ⁽¹⁾	050-102-212	904-523-012
G 3/4" (20 × 27)				904-523-012	050-102-215

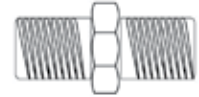
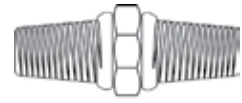

FITTINGS NPT - 870 PSI (60 BAR)		
Male/Male	1/4" NPT	3/8" NPT
1/4" NPT		905-083-201
3/8" NPT	905-083-201	

FITTINGS NPS - 870 PSI (60 BAR)		
Male/Male	1/4" NPS	3/8" NPS
1/4" NPS	050-102-630	050-102-632
3/8" NPS	050-102-632	050-102-631 050-102-652 ⁽¹⁾

ADAPTOR NPS TOWARDS BSP (GAZ) - 870 PSI (60 BAR)		
Male/Male	1/4" NPS	3/8" NPS
G 1/4" BSP	050-102-624 050-102-644 ⁽¹⁾	050-102-646 ⁽¹⁾
G 3/8" BSP	050-102-627 050-102-647 ⁽¹⁾	050-102-628 050-102-648 ⁽¹⁾
G 1/2" BSP	050-102-633	050-102-629 050-102-649 ⁽¹⁾
G 3/4" BSP		050-102-654 ⁽¹⁾

(1) Stainless steel fittings

Female to female connection

Pmax: 870 PSI (60 BAR)

FITTINGS BSP (GAS) - 870 PSI (60 BAR)	
Female/Female	G 1/4" (BSP)
G 1/4" (BSP) (8 x 13)	904-593-002
G 3/8" (BSP) (12 x 17)	904-503-003



ADAPTOR BSP (GAZ) TOWARDS METRIC - 290 PSI (20 BAR)	
Female/Female	G 1/4" (BSP)
M 14 x 125	050-221-401

T FEMALE BSP (GAZ) - 870 PSI (60 BAR)	
Description	Part number
Fittings 3 x G 1/4" (BSP) (8 x 13)	904-303-002
Fittings 3 x G 3/8" (BSP) (12 x 17)	904-303-003
Fittings 3 x G 1/2" (BSP) (15 x 21)	904-303-004
Fittings 3 x G 3/4" (BSP) (20 x 27)	904-303-006

T FEMALE NPT - 870 PSI (60 BAR)	
Description	Part number
Fittings 3 x 1/4" NPT	905-083-301

Female to Male connection

Pmax: 290-870 PSI (20-60 BAR)

ADAPTOR NPS TOWARDS JIC, NPS AND METRIC - 290 PSI (20 BAR)			
Female/Male	#5 JIC	1/4" NPS	3/8" NPS
#5 JIC	-	050-123-304 ⁽¹⁾	-
1/4" NPS	050-123-305 ⁽¹⁾	-	-
3/8" NPS	050-103-537 ⁽¹⁾	050-103-534 ⁽¹⁾	-
14 x 125	-	-	050-123-523

(1) Stainless steel fittings

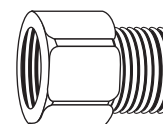

FITTINGS BSP (GAZ) - 870 PSI (60 BAR)			
Female/Male	G 1/4" (8 x 13)	G 3/8" (12 x 17)	G 3/4" (20 x 27)
G 1/4" (8 x 13)	050-123-205	904-533-003	-
G 3/8" (12 x 17)	904-513-003	-	-
G 1/2" (15 x 21)	904-513-005	-	904-533-009
G 3/4" (20 x 27)	904-513-011	904-513-012	-
G 1" (26 x 34)	-	-	904-513-020

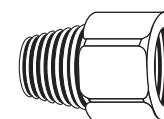

FITTINGS METRIC - 290 PSI (20 BAR)			
Female/Male	M 14 x 125	M 18 x 125	M 26 x 125
M 14 x 125	-	050-123-109	-
M 18 x 125	050-123-101	-	050-123-110
M 26 x 125	-	050-123-106	-

ADAPTOR METRIC TOWARDS NPS - 290 PSI (20 BAR)		
Female/Male	M 14 x 125	M 18 x 125
1/4" NPS	050-123-535	050-123-526
3/8" NPS	-	050-123-532

ADAPTOR JIC TOWARDS METRIC - 290 PSI (20 BAR)		
Female/Male	M 14 x 125	M 18 x 125
#5 JIC	050-230-619	050-230-620

ADAPTOR JIC TOWARDS NPS AND METRIC - 290 PSI (20 BAR)	
Female/Male	#5 JIC
1/4" NPS	050-123-304
3/8" NPS	050-123-533
M 18 x 125	050-123-521

■ Quick fittings for small diameter special air hoses

CONFIGURATION FITTINGS				
C	D	Straight	Right angle 90°	T- piece
G 1/8" (5 x 10) BSP	4	905-120-907	905-120-926	-
G 1/8" (5 x 10) BSP	8	-	905-120-934	-
G 1/4" (8 x 13) BSP	4	-	905-120-927	-
G 1/4" (8 x 13) BSP	6	905-120-965	905-120-905	-
G 1/4" (8 x 13) BSP	8	905-120-904	905-120-912	905-120-920
6 x 8 hose T	T for hose 4 x 6	2,7 x 4 Hose T- piece		4 x 6/2,7 x 4 Reduction T- piece
905-120.915	905-120.903	905-120.957		905-120-928

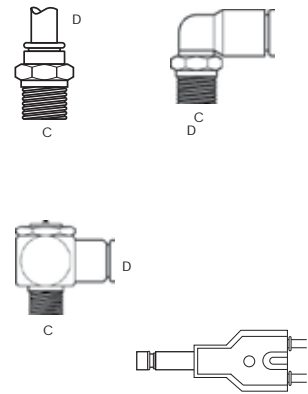

■ ISO 6150 Quick-fit fittings (maximum pressure: 145 PSI (10 BAR))

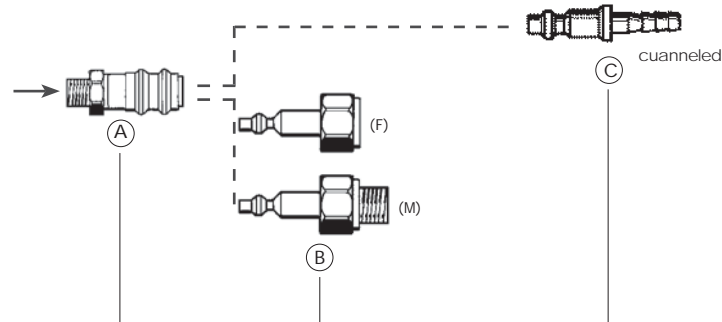

QUICK FITTINGS					
Type	Complete assembly A and B	Part A with built-in shutter valve	Part B	Part C for rubber hose	
				Ø 7	Ø 10
Ø5 (14x125)	905-030-405	905-030-102	905-030-406 (F)	905-030-203	905-030-204
Ø5 (1/4" BSP)	-	-	905-030-804 (M)	-	-
Ø5 (1/4" BSP)	-	-	905-030-803 (F)	-	-
Ø5 (1/4" NPS)	905-030-105	905-030-104	905-030-106 (F)	-	-
Holding collar	-	-	-	906-311-224	906-311-226

COMPLETE QUICK DISCONNECT 1/4" NPS FOR AIR HOSE	
Description	Part number
Air inlet quick-disconnect fitting	905-030-105

QUICK FITTINGS FOR Ø 8 HOSE		
Type	Part A with on/off press button for hose Ø 8	Part C for hose Ø 8
Ø 5	905-030-801	905-030-802

■ Fittings for low pressure polyamide hoses

FITTINGS CONFIGURATION			
Thread size	Material	Hoses Inter. Diameter (mm)	Part number
M 3/8" NPS	Nickel plated brass	6.35 - 1/4	050-231-350
M 1/4" NPS	Nickel plated brass	6.35 - 1/4	050-231-450
M 3/8" NPS	Nickel plated brass	9.52 - 3/8	905-140-103

■ Crimp fittings for low pressure air and fluid rubber hoses

FITTINGS CONFIGURATION				
Material	Thread size	Hoses Inter. Diameter	Part number	Collar
Straight fittings				
Nickel plated brass	1/4" NPS	0.275 in (7 mm)	050-231-705	906-311-224
Nickel plated brass	1/4" NPS	0.315 in (8 mm)	050-231-707	906-311-224
Nickel plated brass	1/4" NPS	0.394 in (10 mm)	050-231-702	906-311-226
Nickel plated brass	3/8" NPS	0.275 in (7 mm)	050-231-716	906-311-224
Nickel plated brass	3/8" NPS	0.394 in (10 mm)	050-231-706	906-311-226
Nickel plated brass	3/8" NPS	0.630 in (16 mm)	050-231-701	906-311-232
Stainless steel	M 14 x 125	0.197 in (5 mm)	050-230-610	906-311-208
Nickel plated brass	M 14 x 125	0.394 in (10 mm)	050-230-602	906-311-226
Nickel plated brass	M 18 x 125	0.275 in (7 mm)	050-230-616	906-311-224
Stainless steel	M 18 x 125	0.394 in (10 mm)	050-230-614	906-311-226
Nickel plated brass	M 18 x 125	0.394 in (10 mm)	050-230-606	906-311-226
Nickel plated brass	M 18 x 125	0.630 in (16 mm)	050-230-601	906-311-232
Nickel plated brass	M 26 x 125	0.630 in (16 mm)	050-230-603	906-311-232
Elbow fittings				
Nickel plated brass	M 18 x 125	0.394 in (10 mm)	050-250-202	906-311-226
Junction fittings without thread				
Nickel plated brass	-	0.275 in (7 mm)	050-190-403	906-311-224
Nickel plated brass	-	0.394 in (10 mm)	050-190-401	906-311-226



■ Plugs Pmax: 290 - 870 PSI (20 - 60 BAR)

PLUGS CONFIGURATION	
Description	Part number
Male	Male
G 1/8" (5 x 10)	906-333-106
G 1/4" (8 x 13)	906-333-102
G 3/8" (12 x 17)	906-333-104
G 1/2" (15 x 21)	906-333-103
G 3/4" (20 x 27)	906-333-105

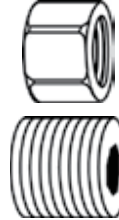

■ Male to male fittings (protective coated steel) Pmax: 5800 PSI (400 BAR)

FITTINGS CONFIGURATION			
Male/Male	#5 JIC	#8 JIC	#10 JIC
#5 JIC	050-102-301	905-160-201	550914
#8 JIC	905-160-201	905-160-202 - - 550545	550915
#10 JIC	550914	550915	-



■ Male to female fittings (stainless steel) Pmax: 5220 PSI (360 BAR)

FITTINGS CONFIGURATION	
Male/Male	#5 JIC
#8 JIC	050-123-301



■ Male to male adapters: Pmax: 5220 PSI (360 BAR)



PROTECTED STEEL FITTINGS CONFIGURATION

Male/Male	#5 JIC	#8 JIC
1/4" NPT	000-972-025	905-160-212
3/8" NPT	000-972-028	905-160-206
1/2" NPT	-	905-160-204
3/4" NPT	-	905-160-203

STAINLESS STEEL FITTINGS CONFIGURATION

Male/Male	#5 JIC	#8 JIC
1/8" NPT	905-210-501	-
1/4" NPT	905-210-502	905-210-512
3/8" NPT	905-210-503	905-210-513
1/2" NPT	905-210-504	905-210-514
3/4" NPT	-	905-210-515

PROTECTED STEEL FITTING CONFIGURATION

Male/Male	#5 JIC	#8 JIC	7/16" JIC	#10 JIC	1 1/16" JIC	1 5/16" JIC
1/8" G co	550548	-	550920	-	-	-
1/4" G co	550542	-	-	-	-	-
3/8" G co	550549	550679	-	550609	-	-
1/2" G co	-	550544	-	550540	550903	-
3/4" G co	550905	-	-	550823	550864	550932
1" G co	-	-	-	-	550900	550901

NICKEL-COATED FITTINGS CONFIGURATION

Male/Male	#5 JIC	#8 JIC
3/8" NPT	050-470-202	905-160-103

■ Male to female elbow fittings Pmax: 5220 PSI (360 BAR)



FITTINGS CONFIGURATION

Male/Female (swivel)	#5 JIC
#5 JIC	905-160-101

■ Male to male elbow fittings (stainless steel) Pmax: 5220 PSI (360 BAR)



FITTINGS CONFIGURATION

Male/Male	#5 JIC	#8 JIC
1/4" NPT	905-210-602	905-210-612
3/8" NPT	905-210-603	905-210-613
1/2" NPT	905-210-604	-
3/4" NPT	-	905-210-615

■ Male to male elbow fittings (protective coated steel) Pmax: 5220 PSI (360 BAR)

NPT FITTINGS CONFIGURATION

Male/Male	#5 JIC	#8 JIC
1/8" NPT	905-160-105	-
1/4" NPT	000-972-176	905-160-102

G CO FITTING CONFIGURATION

Male/Male	#5 JIC	#8 JIC
1/8" G co	905-160-106	-
1/4" G co	550596	550923
3/8" G co	551819	-

■ Plugs Pmax: 5220 PSI (360 BAR)

PLUGS CONFIGURATION

Description	Part number
Female	
#5 JIC	906-333-301
Male	
1/8" NPT	906-333-108

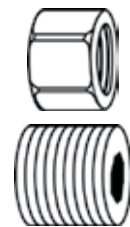

■ Low pressure valves

3 WAYS VALVE PART NUMBERS

Description	Part number
3 x 1/4" BSP	903-090-804
3 x 1/4" BSP (stainless steel)	903-090-805

2 WAYS MALE/MALE VALVE PART NUMBERS

Description	Input	Output	Part number
Ball valve	(M) G 1/4" (8 x 13)	(M) M 14 x 125	050-070-205
Inlet (male) G 3/8" (12 x 17) outlet (male) M 14 x 125	(M) G 3/8" (12 x 17)	(M) M 1/4" NPS	050-070-211
Inlet (male) G 1/2" (15 x 21) outlet (male) M 18 x 125	(M) G 1/2" (15 x 21)	(M) M 18 x 125	050-070-204
Inlet (male) G 1/2" (15 x 21) outlet (male) G 1/2 (15 x 21)	(M) G 1/2" (15 x 21)	(M) G 1/2" (15 x 21)	050-070-201
Inlet (male) G 3/8" (12 x 17) outlet (male) M 18 x 125	(M) G 3/8" (12 x 17)	(M) M 18 x 125	050-070-212

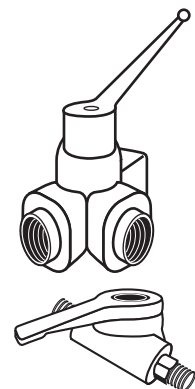

2 WAYS FEMALE/FEMALE VALVE PART NUMBERS

Description	Input	Output	Part number
Valve	(F) 1/4" BSP (8 x 13)	(F) 1/4" BSP (8 x 13)	903-090-806
Valve	(F) 3/8" BSP (12 x 17)	(F) 3/8" BSP (12 x 17)	903-090-206

■ Air bleeding valves

AIR BLEEDING VALVE PART NUMBER

Description	Part number
Inlet thread (male) G 1/4" (8 x 13)	903-093-302

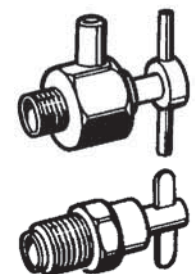

■ Needle valves

2 WAYS VALVE PART NUMBERS

Description	Input	Output	Part number
Female/Male	M 14 x 125	M 14 x 125	050-070-179
Male/Male	G 1/4" (8 x 13)	M 14 x 125	050-070-101

3 WAYS VALVE PART NUMBERS

Description	Part number
Female/male/male M 14 x 125	050-070-401

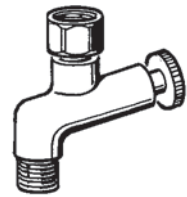

■ AIRLESS fluid valves

PART NUMBER

Description	Input	Output	Maximum fluid pressure	Part number
Female/Female	G 3/8" (12 x 17)	G 3/8" (12 x 17)	3625 psi (250 bar bar)	000-750-040



■ Air line output control valves

VALVE PART NUMBERS

Description	Input	Output	Part number
Female/Male	G 1/4" (8 x 13)	G 1/8" (8 x 13)	050-070-190
Female/Male	M 14 x 125	M 14 x 125	050-070-179

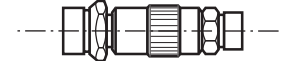

■ Bleeding valves

BLEEDING VALVES PART NUMBERS

Description	Input	Output	Maximum fluid pressure	Part number
Male/Male	G 1/4" (8 x 13)	M 18 x 125	5800 psi (400 bar)	000-760-000

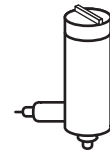

■ Fittings - General information

DETAILS

Denomination	Fitting characteristics	Geographical area	Max. operating pressure
M	cylindrical metric	France	290 psi (20 bar)
G = BSP	conical gas (or cylindrical)	Europe - Asia	870 psi (60 bar)
NPT	conical	USA - Asia	870 psi (60 bar)
NPS	cylindrical	USA - Asia	870 psi (60 bar)
JIC	cylindrical angle 74°	Universal	5220 psi (360 bar)

■ Regulators

1/4" (with grey or red knob) , 1/2" and 3/4" (with red ring) regulators are used on the compressed air lines.

CHARACTERISTICS

Regulator	1/4"	1/2"	3/4"
Max. inlet pressure (bar)	9	20	21
Max. output (m ³ /h)	25	210	360

CONFIGURATION

Description	Pressure	Type	Part number
Red knob regulator	50 psi (3.5 bar)	1/4"	016-240-000
Grey knob regulator	50 psi (3.5 bar)	1/4"	016-380-000
2 regulators 1/4" with isolating valves 2 Gauges, 1 inlet valve - 1 outlet valve M 1/4" NPS	50 & 130 psi (3.5 & 9 bar)	1/4"	019-400-000
Grey knob regulator	80 psi (5.5 bar)	1/4"	016-390-000
Red knob regulator	80 psi (5.5 bar)	1/4"	016-370-000
Regulator with pressure gauge inlet fitting 1/4" - outlet fitting M 1/4" NPS	80 psi (5.5 bar)	1/4"	019-720-000
Grey knob regulator	130 psi (9 bar)	1/4"	016-360-000
Bare regulator	58 psi (4 bar)	1/2"	016-200-000
Bare regulator	130 psi (9 bar)	1/2"	016-280-000
Equipped regulator with pressure gauge and wall bracket	145 psi (10 bar)	1/2"	019-780-100
2 regulators (1/4" + 1/2") with isolating valves 2 Gauges, 1 inlet valve - 2 outlet valves M 1/4" NPS	130 psi (9 bar)	1/4"	019-390-000
Red ring regulator	145 psi (10 bar)	1/2"	016-470-000
Red ring regulator	145 psi (10 bar)	3/4"	016-480-000



PRACTICAL PAGES

Choosing a pump

To optimize

- For the best pump capacity, first work out the output you are going to require. This will include the spray guns themselves, and any circulation you plan to have within this system. Once you have this figure, multiply by 1.2, and then choose the pump of which output at 30 cycles per minute is the nearest.
- The compression ratio you will need is defined by the pressure losses due to the length and diameter of the hosing of your system. To calculate these pressure losses, see page 4.

Example

let say you want to feed 3 conventional guns with an output of 500 cart mount each, plus a circulation of 0,5 L/mn. The total output will thus be 2 L/mn. The optimal pump capacity would be: $(2\ 000 \times 1,2) \div 30 = 80$ cc/cycle. The best-suited pumps will be:

- the PMP 150 (output of 100 cc/cycle and pressure ratio of 1:1) for low viscosity materials and a small circulating (pressure loss < 3 bar).
- the 02.75 (output of 85 cc/cycle and pressure ratio of 2:1) for thicker materials and a normal circulating (pressure loss < 6 bar).
- the 04.120 (output of 240 cc/cycle and pressure ratio 4:1) for large pressure loss in circulating (up to 15 bar).

Pump Material Feeding

To guarantee the right delivery of product, we offer the following range of equipment for various product viscosity:

- 0 - 300 cps
 - suction rod.
- 300 to 8 000 cps
 - top outlet pressure pots,
 - pumps (gravity or suction rod),
 - pump with base intake valve.
- 8 000 to 15 000 cps
 - bottom outlet pressure pots,
 - pumps with suction rods,
 - compressor.
- 15 000 to 30 000 cps
 - no more pressure pot,
 - no more suction rod,
 - submerged hydraulic pump,
 - compressor,
 - pump with single action elevator.
- 30 000 à 1 000 000 cps and +
 - pumps with peak feeder and double action elevator.

Filtration equivalence

Mesh (number of holes in 25,4 mm)	Micron	N° filter (mesh opening in µm)
10	1480	-
16	975	-
20	750	30
25	630	25
30	500	20
40	375	-
45	360	15
50	300	12
60	238	-
70	210	8
80	175	6
100	149	-
140	100	4
170	90	3
200	74	-
250	60	-
270	50	2
325	40	1
400	35	-

Pressure loss in fluid hoses

Pressure drop is the resistance that prevents material from moving forward in the pipe. Two pipe variables influence this resistance: the (inside/internal) diameter and the pipe length. The pump will generate a pressure, strong enough to move the fluid material through the pipe (or hose) to the material pipe outlet. This pressure must be enough to overcome the original pressure drop. While it is hard to reduce the pipe length, it is relatively easy to select an appropriate internal pipe diameter.

PRESSURE DROP CALCULATION

$$\text{Pressure loss (bar/m)} = \frac{6.9 \times \text{Flow (l/min)} \times \text{Viscosity (cps)}}{D^4 \text{ (int dia in mm)}}$$

$$\text{Pressure loss (psi/Ft)} = \frac{2.73 \times \text{Flow (gpm)} \times \text{Viscosity (cps)}}{D^4 \text{ (int dia in inches)}}$$

FLOW RATE CALCULATION

$$\text{Flow (l/min)} = \frac{\text{Pressure loss (bar/m)} \times D^4 \text{ (int dia in mm)}}{6.9 \times \text{Viscosity (cps)}}$$

$$\text{Flow (gpm)} = \frac{\text{Pressure loss (psi/Ft)} \times D^4 \text{ (int dia in inches)}}{2.73 \times \text{Viscosity (cps)}}$$

PIPE DIAMETER CALCULATION

$$\text{Interior Dia (mm)} = \sqrt[4]{\frac{6.9 \times \text{Flow (l/min)} \times \text{Viscosity (cps)}}{\text{Pressure Loss (bar/m)}}}$$

$$\text{Interior Dia (in)} = \sqrt[4]{\frac{2.73 \times \text{Flow (gpm)} \times \text{Viscosity (cps)}}{\text{Pressure loss (psi/Ft)}}}$$

Pressure loss in air hoses

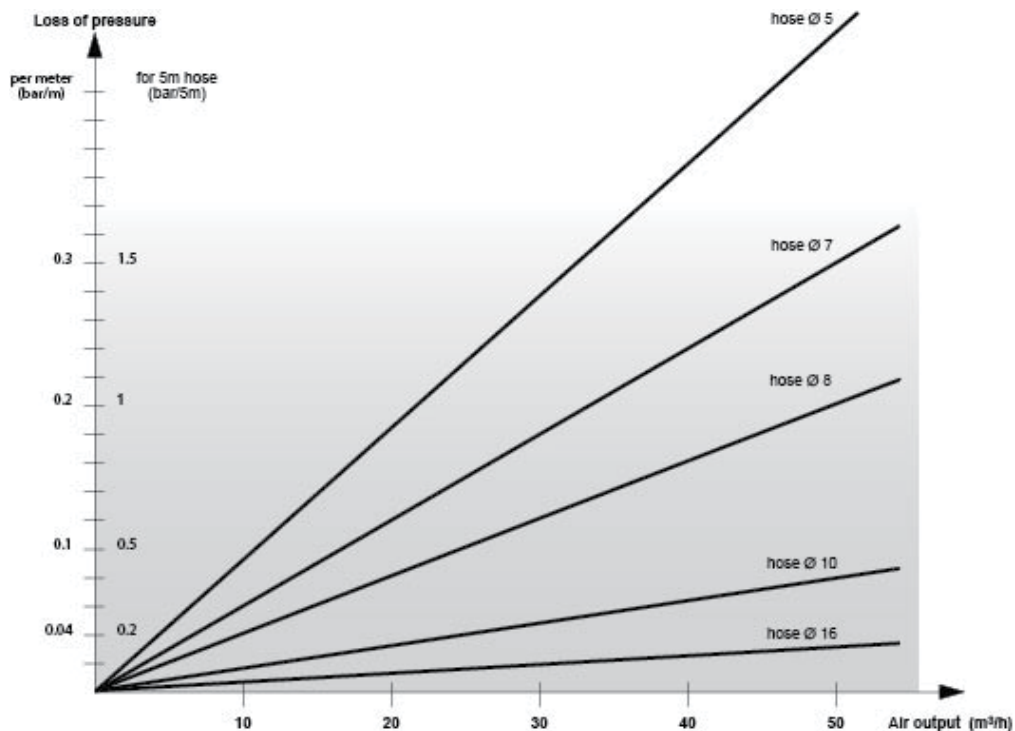

Electrostatic spraying : suitability of the equipment depending on the resistivity of the paints

- The wrap-around affect is optimized with paints of resistivity range of 5 - 50 MΩ.cm..
- Specific hoses allows for wrap-around effects for resistivity range higher than 2MΩcm.
- For water-based materials (0 MΩ.cm), a special ISO Bubble enclosure allows to benefit from all the advantages of electrostatic spraying in complete safety.

On the Kremlin Rexson resistivity meter, resistivity can be read directly on the display.

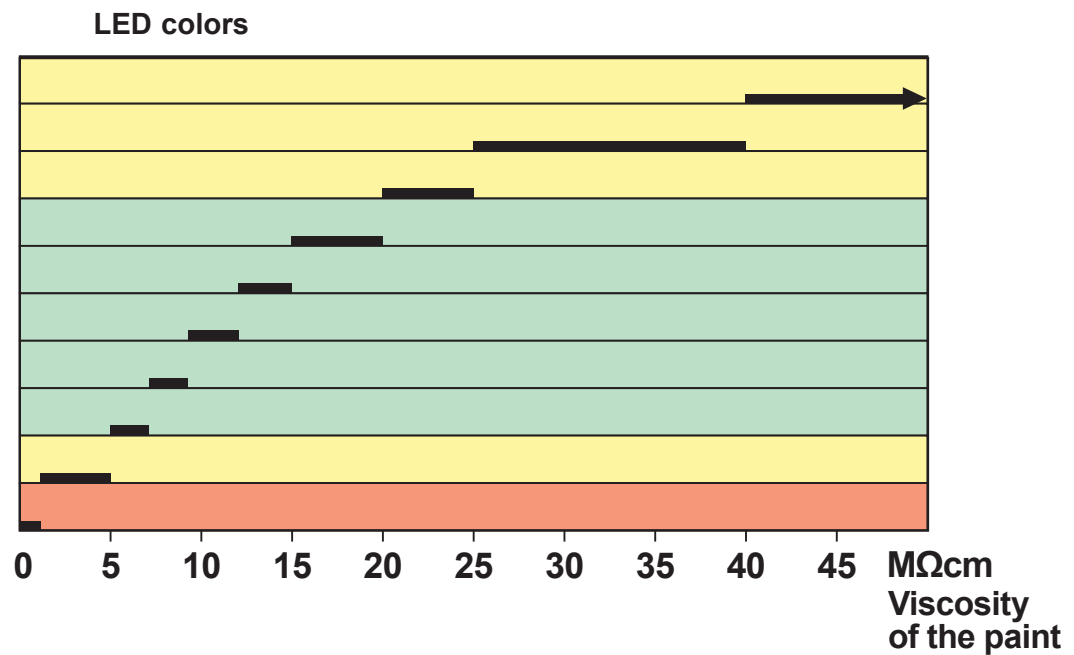

Compressed air consumption of normal air tools

We generally multiply the instant consumption by a coefficient of 0.5 to 0.9 to allow for the time the tool is not in use.

The average air volume delivered by a compressor of 1 CV is of 8 m³/h.

Tool	Consumption	
	L/mn	m ³ /h
Projection equipment	800 at 1 800	48 at 108
Riveter	450 at 1 500	27 at 90
Pneumatic drill	600 at 1 200	36 at 72
Linisher Ø 230	1 200 at 4 000	72 at 240
Drill 13 mm	600	36
Rotating sander	200 at 400	12 at 24

Tool	Consumption	
	L/mn	m ³ /h
KREMLIN conventional gun	160 at 500	10 at 30
AIRMIX® gun	67 at 134	4 at 8
KREMLIN pumps	160 at 1 350	10 at 80
Blower	200 at 400	12 at 24
Screwdriver	200 at 400	12 at 24

Calculate exactly the maximum air consumption of pump in L/mn : Q

The formula is :

$$Q = 1.2 \times \text{fluid output} \times \text{pressure ratio} \times (\text{air motor feeding pressure in bar} + 1 \text{ bar for atmosphere})$$

Example for a pump 16.120 : $Q = 1.2 \times 4,8 \times 16 \times (6 + 1) = 645.12 \text{ L/mn}$ or $(645.12 \times 60) : 1000 = 38.7 \text{ m}^3/\text{h}$

Value of "pH"

The pH value of a liquid or a solution quantifies its concentration of hydrogen ions and tells us the extend to which it is acidic or alkaline. The PH value dictates the best materials to be used in construction of major paint handling and spraying equipment.

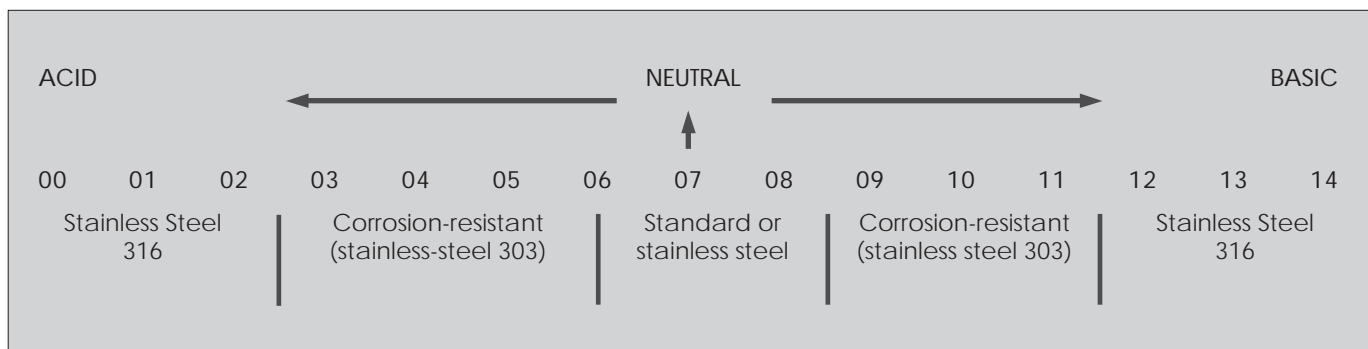

Practical information: Metric - English conversion

CONVERT FROM	TO	MULTIPLY BY
Centimeters	feet	0.03280
Centimeters	inches	0.3937
Centimeters/min.	feet/min.	1.9684
Centimeter/Sec.	feet/sec.	0.03281
Cubic centimeters.	cubic feet	3.5314×10^{-5}

CONVERT FROM	TO	MULTIPLY BY
Cubic centimeters	ounces	0.033
Cubic centimeters	liquid gallons	0.0002642
Cubic feet	liquid gallons	7.4805
Cubic feet	cubic inches	1.728
Cubic feet/min.	gallons/min.	7.4805

CONVERT FROM	TO	MULTIPLY BY
Cubic inches	gallons	0.004329
Cubic inches	cubic centimeters	16.387
Cubic inches	cubic feet	0.0005787
Cubic meters	liquid U.S. gallons	264.17
Cubic meters	cubic centimeters	1×10^6

CONVERT FROM	TO	MULTIPLY BY
Cubic meters	cubic feet	35.31
Cubic meters	cubic inches	61,023.38
Feet	centimeters	30.48006
Feet	meters	0.3048006
Feet of water	atmosphere	0.02949

CONVERT FROM	TO	MULTIPLY BY
Feet of water	psi	0.443
Feet/hour	miles/hour	0.00018933
Feet/min.	meters/min.	0.3048
Feet/min.	miles/hour	0.01136
Feet/sec.	miles/hour	0.681818

CONVERT FROM	TO	MULTIPLY BY
Gallons	cubic cm	3 785.43
Gallons	cubic inches	231
Gallons	imperial gallons	0,83268
Gallons	cubic feet	0,13368
Gallons/min.	cubic feet/min.	0,13368

CONVERT FROM	TO	MULTIPLY BY
Inches	feet	0,083333
Inches	meters	0,254
Inches	millimeters	25,40005
Inches	mils	1 000
Kilograms	pounds	2,2046

CONVERT FROM	TO	MULTIPLY BY
Kilograms/cm ²	psi	14,2233
Kilograms/mm ²	psi	1 422,33
Liters	gallons	0,264178
Meters	feet	3,2808
Meters	inches	39,37

CONVERT FROM	TO	MULTIPLY BY
Poise	centipoise	100,0
Pints of water	gallons	0,11985
PSI	atmosphere (bar)	0,06804
Inches ²	cm ²	6,4516
Inches ²	feet ²	0,006944
Inches ²	mm ²	645,163
Millimètres ²	inches ²	0,0015499
daN	Kilograms	1.0

- For the diameter of a circle, multiply the circumference by 0.31831.
- For the circumference of a circle, multiply the diameter by 3.1416.
- For the surface of a circle, multiply the diameter² by 0.7854.
- For the surface of a sphere, multiply the diameter² by 3.1416.
- To find the side of a square that has the same surface area of a circle, multiply the diameter by 0.8862.
- To find the number of cubic inches in a sphere, multiply the diameter by 0.5236.
- To find the number of gallons inside a pipe or cylinder, divide the volume in liters by 231.
- To find the cubic volume of a cylinder or pipe, multiply the section area by the length.

Chemical compatibility charts

MATERIAL IN CONTACT (WETTED PARTS)									
	Carbon steel	Aluminium	Brass	Stainless steel	Nylon	Nitrile	Vitton	Leather	P.U.
Butyl acetate	👍👍👍	👍👍👍	👍👍👍	👍👍👍	👍👍👍	N	N		N
Ethyl acetate	👍👍	👍👍	👍👍	👍👍	👍👍👍	N			
Acetaldehyde	👍👍👍	👍👍👍	👍👍👍	👍👍👍	👍👍👍	N	N	👍👍	N
Ammonium acetate				👍👍👍					
Acedic acid	👍👍👍			👍👍👍	👍👍👍	N	N	N	N
Boric acid	👍👍👍	👍👍👍		👍👍👍	👍👍👍		👍👍👍	👍👍👍	👍👍👍
Hydrobromic acid					👍👍👍	N	👍👍👍		
Chloridic acid	N	N		N	👍👍👍	N	👍👍👍		
Chromic acid	N	N	N	👍	👍👍👍	N			
Citric acid				👍👍👍	👍👍👍		👍👍👍		
Fluorohydric acid						N	👍👍👍		
Fluosilicic acid			👍👍👍		👍👍👍	N	N		
Formic acid	N	👍👍	N	👍	👍👍👍	N	👍		
Nitric acid	N	N	N	👍👍👍	👍👍👍	N	👍👍👍		
Oxylic acid	N	N	N	N	👍👍👍		👍👍👍	👍👍👍	👍👍👍
Phosphoric acid	N	N		👍👍👍	👍👍👍	N	👍👍👍		
Ethylalcohol						👍👍👍	N		
Methylalcohol	👍👍👍						N	👍👍👍	N
Acetic aldehyde	👍👍👍	👍👍👍		👍👍👍	👍👍👍	N	N		N
Formic aldehyde	N	👍👍	N	N	👍👍👍	N	👍👍👍		N
Sodium alginate					👍👍👍		N		
Starch						👍👍👍	👍👍👍		
Amines					👍👍👍	N	N	N	
Acetone	👍👍👍	👍👍👍		👍👍	👍👍👍	N	N		N
Liquid ammonia	👍👍👍	👍👍👍		👍👍👍	👍👍	👍👍	N	N	
Benzene	👍👍👍	👍👍👍	👍👍👍	👍👍👍	👍👍👍	N	👍👍👍	👍👍	👍
Sodium bicarbonate		N	N	👍👍👍	👍👍👍	👍👍👍	👍👍👍	👍👍👍	
Chlorine dioxide						N	👍👍👍		
Sodium bisulphate	N	N		N	👍👍👍	N	👍👍👍		
Brominate						N			
Calcium carbonate	👍👍👍			👍👍👍	👍👍👍	👍👍👍	👍👍👍	👍👍👍	
Sodium carbonate					👍👍👍		👍👍👍		
Chlorinate, gas						👍👍👍	👍👍👍		
Sodium chlorite							👍👍👍		👍👍👍
Aluminum chlorosulfate					👍👍👍	👍👍👍	👍👍👍	👍👍👍	
Calcium chloride	👍👍👍			👍👍👍	👍👍👍	👍👍👍	👍👍👍	👍👍👍	👍👍👍
Magnesium chloride	👍👍	N		N	👍👍👍	👍👍👍	👍👍👍	👍👍👍	👍👍👍
Potassium chloride	N	N		👍👍	👍👍👍	👍👍👍	👍👍👍	👍👍👍	👍👍👍
Sodium chloride					👍👍👍	👍👍👍	👍👍👍	👍👍👍	👍👍👍
Zinc chloride	N	N		N	👍👍👍	👍👍👍	👍👍👍		👍👍👍
Ferrous chloride	N	N	N	N	👍👍👍	👍👍👍	👍👍👍		
Ferric chloride	N	N	N	N	👍👍👍	👍👍👍	👍👍👍		👍👍👍
Cyclohexane	👍👍👍	👍👍👍	👍👍👍	👍👍👍	👍👍👍	👍👍👍	👍👍👍		
Chlorobenzene	👍👍👍			👍👍👍	👍	N	👍👍👍		N
Ethylene chloride		👍👍			👍👍	N	👍👍		N
Methylene chloride	👍👍	N	👍👍	👍👍	N	N	👍👍		N
Diatoms						👍👍👍	👍👍👍		
Dichloroethylene					👍👍👍				
Diethylene glycol	👍👍👍	👍👍		👍👍👍	👍👍👍	👍👍👍	👍👍👍		N

👍👍👍 = High Compatibility 👍 = Low Compatibility
 👍👍 = Good Compatibility N = Not Compatible

Practical information: Chemical compatibility charts

MATERIAL IN CONTACT (WETTED PARTS)									
	Carbon steel	Aluminium	Brass	Stainless steel	Nylon	Nitrile	Viton	Leather	P.U.
Bleach	N	👍👍		👍👍👍	👍👍👍				👍
Distilled water	N	👍👍👍	👍👍👍	👍👍👍	👍👍👍		👍👍👍	👍👍👍	👍👍👍
Oxygenated water	N		N	👍👍	N		👍👍		👍👍👍
EDTA						👍👍👍	N		
Fertilizer						👍👍👍	N		
Ethanol					👍👍👍	👍👍👍	N		
Ethyl ether	👍👍	👍👍		👍👍	👍👍👍	N	N		👍
Ethylene glycol	👍👍	👍👍	👍👍👍	👍👍	👍👍👍	👍👍👍	👍👍👍		N
Ethyl-mercapan						N	👍👍👍		
Fuel						N	👍👍👍		
Fluosilicate			👍👍👍		👍👍👍	👍👍👍	👍👍👍		
Formaldehyde	N	👍👍		N	👍👍	👍👍👍	👍👍👍		N
Glycol	👍👍	👍👍		👍👍	👍👍👍	👍👍👍	👍👍👍		N
Gelatine	N	👍👍		👍👍👍	👍👍👍	N	N		N
Sodium hydroxide					👍👍👍	N	N		N
Ammonium hydroxide				👍👍👍	👍👍👍	N	N	👍👍	N
Potassium hydroxide	👍	N		👍👍	👍👍👍	N	N		N
Calcium hypochlorite				👍	👍👍👍	N	👍👍👍	N	
Sodium hypochlorite					👍👍👍	N	👍👍👍		N
Sodium hyposulfite					👍👍👍	N	👍👍👍		
Fruit juice						👍👍👍	👍👍👍		
Methanol	N	👍👍👍		👍👍👍			N		👍
Morpholine	👍👍👍	👍👍👍				N	N		
Methylethylcetone	👍👍👍	👍👍		👍👍👍	👍👍👍	N	N		N
Sodium nitrite					N	N	👍👍👍		
Perchlorethylene (tetrachloret.)	👍👍👍	👍👍		👍👍👍	N	👍👍	👍👍👍		N
Permanganate de potassium	👍👍	👍👍		👍👍	👍👍👍	N	👍👍👍		
Hydrogen peroxide	N	👍👍👍	N	👍👍		N	👍👍		
Chlorohated Peroxyde						N	👍👍👍		
Phenol	N	N			👍👍👍	N	👍👍👍		
Ammonium phosphate			👍👍👍	👍👍👍	👍👍👍	👍👍👍	👍👍👍		
Tridsodium phosphate	👍👍👍	N		👍👍👍	👍👍👍	👍👍👍	👍👍👍		
Aluminium polychlorite						👍👍👍	👍👍👍		
Polyelectrolytes						👍👍👍	👍👍👍		
Caustic potash		N		👍👍👍		N	👍👍👍		
Sodium silicate				👍👍👍	👍👍👍	👍👍👍	👍👍👍		
Soda						N	N		
Aluminium sulfate					👍👍👍	👍👍👍	👍👍👍	👍👍👍	N
Ammonium sulfate					👍👍👍				👍👍👍
Calcium sulfate	👍👍👍	👍👍👍		👍👍👍	👍👍👍		👍👍👍		
Copper sulfate				👍👍👍	👍👍👍	👍👍👍	👍👍👍		👍👍👍
Ferrous sulfate		N		👍👍	👍👍👍	👍👍👍	👍👍👍		
Ferric sulfate	N	N		N	👍👍👍	👍👍👍	👍👍👍		👍👍👍
Sodium sulfate	N				👍👍👍	👍👍👍	👍👍👍		
Hydrogen sulfur	👍👍👍				👍👍👍	👍👍👍	N		
Carbon tetrachloride	👍👍		👍👍👍	👍👍👍	👍👍👍	N	👍👍👍		
Toluene	👍👍👍	👍👍👍		👍👍👍	N	N	👍👍👍		N
Trichlorethane	👍👍	N		👍👍	N	N	👍👍👍		N
Trichlorethylene	👍👍	👍👍👍		👍👍	N	N			N
Triethyleneglycol				👍👍	👍👍👍		👍👍👍		
Urea	👍👍	👍👍		👍👍	👍👍👍		👍👍👍		
Xylenes	👍👍	👍👍		👍👍	👍👍👍	N	👍👍👍		N

INDEX

EDITORIAL

Table of Contents	1
Our Markets	2-3
Kremlin Rexson equipment paint family chart	4
Surface Preparation	5
Paints	6
Viscosity chart	7
Temperature viscosity chart	8
Drying of Paint	9
Key	9
Performances of each Spraying Technology	10
Recommended Equipment - Wood Industry	11
Recommended Equipment - Metal Industry	12
Recommended Equipment - Plastic Industry	13

AIRSPRAY SPRAYING

M22 SPRAY GUNS

M22 G HTi	16-17
M22 G HPA	18-19
M22 G HPA exploded view	20
M22 G BasiK HPA	21
M22 G BasiK HPA exploded view	22
M22 G HPA GSP	23
M22 P HTi	24-25
M22 P HPA	26-27
Special needles and nozzles for M22 P	28
M22 P HPA exploded view	29
M22 P BasiK HPA	30-31
M22 P WBE HPA	32
M22 P HTV	33
M22 A HPA	34
M22 A HPA Exploded view	35
M22 A BasiK HPA	36
M22 A BasiK HPA exploded view	37
Aircaps M22	38
Test aircap - HVLP compliance	38

S3 SPRAY GUNS

S3 G HTi	39
S3 G HPA	40
S3 G HPA exploded view	41
S3 A HPA	42-43
S3 P HTi	44-45
S3 P HPA	46
Aircaps S3	47
Cup lid & liners	47

AIRSPRAY GUN ACCESSORIES

Extensions for M22 pressure fed guns	48
M22 G & S3 G adapter	48
Gravity cups	48
Suction cup-non drip system	48
Gravity pressure cup for M22 GSP	49
Hose sleeve	49
Test aircap - HVLP compliance	49
Accessories and filters for airspray guns	49
Gun cleaning kit	49

MODULAR AUTOMATIC GUNS

A35 HTi	50-51
A35 HPA	52-53
A25F Flowmax®	54-55

NON-MODULAR AUTOMATIC GUNS

A29 HTi	56-57
A29 HPA	58

A29 & A35 Aircaps needles and nozzles.....	59
A28 HPA	60-61
A3 HPA	62-63
AIRSPRAY PUMPS	
PMP-150 Pump	64-65
PMP-150E Pump	66
PMP-150 Transfer pump.....	67
02.75 Pump	68-69
PRESSURE POTS	
2.5 Gallon pressure pot	70
2 Quart pressure cup.....	71
HEATERS	
AD 60/61 Heaters explosion proof	72
One-Pass™ Heater explosion proof	73
ACCESSORIES FOR HOT CIRCULATION	
Circulation valve (for solvent materials)	74
Y-Fitting for one additional spray gun.....	74
AIRSPRAY CIRCULATING	
CTM color change valves	75
PDM 01.175 Pump.....	76
04.120 Pump	77
04.120F Flowmax® Pump	78
04.220FT Flowmax® Turbo Pump	79
EOS 03-R440.....	80
EOS 06-R440.....	81
PRESSURE REGULATOR	
Pressure regulator-low pressure manual control.....	82
Pressure regulator-piloted low pressure	82-83
Back pressure regulator-low pressure.....	83
Low pressure gauges	83
FILTRATION	
Filter 870 psi (60 bar)	84
Suction rod strainers	84
Fluid filter for screen and cartridges	84
AGITATORS	
Cyclix™ agitators	85
Agitator 5 gallon.....	85
Agitator 55 gallon	85
HOSES	
Product hoses for airspray spraying.....	86
Air hoses.....	87
Hose sleeve	87
MISCELLANEOUS	
Lubricants and greases for pumps	88
M22/Xcite™ gun wrench	88
Large-small brush.....	88
Filter wrench	88
Large blow gun.....	88
Viscosity cup	88
Thickness gauge	88

AIRMIX® SPRAYING

AIRMIX® SPRAY GUNS

Xcite™ Airmix® 120 & 200 bar	92-93
Xcite™ Airmix® 120 & 200 bar exploded view	94-95
Xcite™ Airmix® 400 bar.....	96-97
Xcite™ Airmix® 400 bar exploded view	98-99
Airmix® Tips Chart	100

AIRMIX® GUN ACCESSORIES

Micro screens and tip seals	101
Tip cleaning needles.....	101
Unclogging needle holder	101
Seats for spray guns.....	101
Gun fluid filter screen.....	101

Atomizing air needle valve.....	101
Extensions for Airmix® spray guns	102
Y-fitting for one additional gun	102
Two gun manifold (stainless steel)	102
Gun cleaning kit	102
AIRMIX® AUTOMATIC GUNS	
AVX Airmix®	104-105
ATX Airmix®	106
AXC Airmix®	107
Aircaps for AVX, AXC and ATX.....	108
ACCESSORIES FOR AIRMIX® SPRAY GUNS	
Microscreens and tip seals	110
Tip cleaning needles	110
Seats for automatic spray guns	110
Unclogging needle holder	110
In-line paint filter.....	110
Gun fluid filter screen.....	111
Extension for AVX and AXC spray guns	111
Gun cleaning kit	111
AIRMIX® PUMPS	
EOS 10-C18 Pump & Xcite™	112-113
EOS 15-C25 Pump	114-115
EOS 30-C25 Pump	116-117
10.25 GT Pump	118
20.25 Pump	119
20.50 & 20.50T Pump.....	120
40.25 Pump	122
40.25 WB Pump	123
40.50 Pump	124
40.50 WB Pump	125
AIRMIX® FLOWMAX® PUMPS	
17.A2 Flowmax® Pump	126-127
20.25F Flowmax® Pump	128
20.50F & 20.50 FT Flowmax® Pump	129
34.A2 Flowmax® Pump	130-131
40.25F Flowmax® Pump	132
40.50F Flowmax® Pump	133
HEATERS	
AD 60/61 Heaters explosion proof	134
One-Pass™ Heater explosion proof	135
ACCESSORIES FOR HOT CIRCULATION	
Y-fitting stainless steel	136
Circulation valve SS for solvent based materials	136
Airmix® back pressure regulator	136
CIRCULATING AIRMIX®	
CTM color change valves	137
08.120T Pump	138
08.120FT Flowmax® Pump.....	139
16.120T Pump	140
16.120FT Flowmax® Pump.....	141
08.220FT Flowmax® Pump.....	142
20.220FT Flowmax® Pump.....	143
PRESSURE REGULATORS	
Pressure regulator - manual control Airmix®	144
Pressure regulator - piloted Airmix®	144
Back pressure regulator - Airmix®	145
High pressure gauges.....	145
FILTRATION	
Filter 3480 psi (240 bar)	146
Inline fluid filters 2900 psi (200 bar)	146
Strainers for suction rods	146
Screens and cartridges for product filter	146
HOSES	
Fluid hoses for Airmix® spraying	148
Product hoses for suction rod.....	148
Nitrile air hoses.....	149
Polyamide or Polyurethane air hoses.....	149

Hose sleeve	149
MISCELLANEOUS	
Lubricants and greases for pumps	150
Ergo hose kit	150
M22/Xcite™ gun wrench	150
Large-small brush	150
Filter wrench	150
Large blow gun	150
Viscosity cup	150
Thickness gauge	150
Gun cleaning kit	150
AIRLESS SPRAYING	
AUTOMATIC AIRLESS SPRAY GUNS	
Airless ASI 24 and 40	155
Airless ASI 40 GT	156
Airless AS2	157
Diaphragms for Airless ASI 24 and 40	158
AUTOMATIC AIRLESS SPRAY GUNS ACCESSORIES	
Flat tips	159
Conical tips	159
AIRLESS PUMPS	
EOS 30-C25 Airless pump	160-161
40.25 Pump	162
40.25 WB Pump	163
40.50 Pump	164
40.50 WB Pump	165
AIRLESS FLOWMAX PUMPS	
34.A2 Flowmax® Pump	166
40.25F Pump	167
40.50FT Flowmax® Pump	168
40.130F Flowmax® Pump	169
AIRLESS FLOWMAX® PUMPS ACCESSORIES	
Screen and cartridges for fluid filter	170
Strainer for suction rods	170
AGITATORS	
Cyclix™ agitators	171
5 gallon agitator	171
55 gallon agitator	171
HOSES	
Airless polyamide fluid hoses	173
Airless PTFE fluid hoses	174
Product hoses for suction rods	174
MISCELLANEOUS	
Lubricants and greases for pumps	175
Gun cleaning kit	175

ELECTROSTATIC SPRAYING

MANUAL ELECTROSTATIC GUNS

Nanogun	178-179
KMV 3 EX	180
Aircaps, tips, needles for KMV 3 EX	181
KMP 3 EX	182
Aircaps, tips, needles for KMP 3 EX	183
KMX 3 EX	184
Aircaps, tips, needles for KMX 3 EX	185
KMC 3 EX	186
Aircaps, tips, needles for KMC 3 EX	187
STD9 power supply for manual guns	188
Air and fluid hoses for K3 EX GUNS	188

MANUAL H2O ELECTROSTATIC GUNS

KMV 3 H2O	189
Aircaps, tips, needles for KMV 3 H2O	189

KMP 3 H2O	190
Aircaps, tips, needles for KMP 3 H2O.....	190
KMX 3 H2O	191
Aircaps, tips, needles for KMX 3 H2O.....	191
Special tips with dielectric insert	192
KMC 3 H2O	193
Aircaps, tips, needles for KMC 3 H2O.....	193
ISO BUBBLE II.....	194
STD 9 B power supply for H2O manual guns.....	195
Feeding hoses for H2O guns.....	195
AUTOMATIC ELECTROSTATIC GUNS	
KAX EX	196
Aircaps, tips, needles for KAX EX.....	197
Special tips with dielectric insert	197
STD 9 A power supply for automatic guns.....	198
Generator barrel, special HT cable.....	198
SPECIFIC ELECTROSTATIC EQUIPMENT	
Conversion kits	199
AP 1000 resistivity gauge.....	199
Spray gun cover	199
Hose sleeve	199
In-line paint filter.....	199

PLURAL COMPONENT PUMPS AND MACHINES

MECHANICAL MIXING

PU 2125 F	202
PU 2160 F	203

ELECTRONIC DOSING

PU 3000.....	204-205
CYCLOMIX™ MICRO and MICRO+ PH	206
CYCLOMIX™ MULTI AND MULTI PH.....	207
CYCLOMIX™ EXPERT	208-209

FITTINGS AND AIR TREATMENT

Male to male connection pmax 290 psi (20 bar)	212
Male to male connection pmax 870 psi (60 bar)	213
Female to female connection pmax 870 psi (60 bar)	214
Female to Male connection pmax 290-- 870 psi (60 bar).....	214
Quick fittings for small diameter special air hoses	215
ISO 6150 quick-fit fittings 145 psi (10 bar)	215
Fittings for low pressure polyamide hoses.....	215
Crimp fittings for low pressure air and fluid rubber hoses.....	216
Plugs pmax 290-870 psi (20-60 bar)	216
Male to male fittings protective coated steel pmax 5800 psi (400 bar)	216
Male to female fittings stainless steel pmax 5220 psi (360 bar)	216
Male to male adapters pmax 5220 psi (360 bar)	217
Male to female elbow fittings pmax 5220 psi (360 bar)	217
Male to male elbow fittings stainless steel pmax 5220 psi (360 bar).....	217
Male to male elbow fittings protective coated steel pmax 5220 psi (360 bar)	218
Plugs pmax 5220 psi (360 bar)	218
Low pressure valves.....	218
Air bleeding valves	218
Needle valves	219
Airless fluid valves.....	219
Air line output control valves.....	219
Bleeding valves.....	219
Fittings - general information.....	219
Regulators.....	220

PRACTICAL PAGES

Choosing a pump 222
Pump material feeding 222
Filtration equivalence 222
Pressure loss in fluid hose 223
Pressure loss in air hose 223
Electrostatic spraying - resistivity chart 224
Compressed air for normal tools 225
Value of "PH" 225
Metric to English conversion 226
Chemical capability chart 227-228

INDEX

Index 230-235

EXPERTS IN FINISHING AND DISPENSING SOLUTIONS FOR ALL MARKETS WORLDWIDE

WHERE TO FIND US ?

www.kremlinrexson-sames.com/en/usa/



KREMLIN REXSON, creator of AIRMIX®, FLOWMAX® and CYCLOMIX™ technologies, offers a broader and various range of gun and pumps for the application of paints, sealants and adhesives.

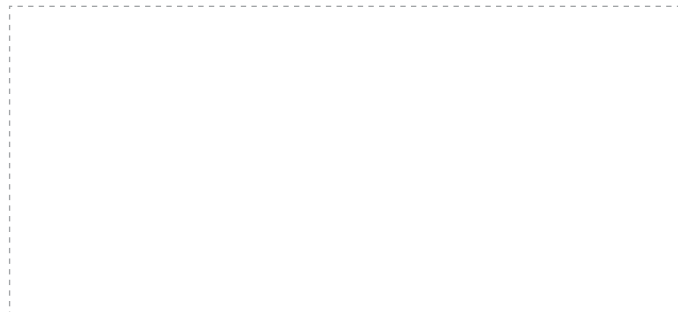

www.exel-na.com

EXEL North America, Inc.
North American Headquarters
45001 5 Mile Road
Plymouth, MI 48170
Toll Free: (800) 573-5554
Phone: (734) 979-0100
Fax: (734) 927-0064

EXEL North America, Inc.
Canadian Branch
931 Progress Ave., Unit 7
Scarborough, Ontario M1G 3V5
Toll Free: (800) 450-0655
Phone: (416) 431-5017
Fax: (416) 431-9171

EXEL-NA, S.A. de C.V.
Acceso III N°16A Int 15A
Conjunto Quadrum
Parque Industrial Benito Juárez
Santiago de Querétaro, Qro.
México, C.P. 76120
+52 (442) 209-5027 /161-2595 Ext 170 Oficina