

ADDICTED TO WORK



## AIRLESS® PAINT SOLUTION

for demanding protective coating application

SFlow™  
spray gun

Azur™  
airless pump



Document with  
AUGMENTED REALITY  
content

Apply Your Skills

[www.sames-kremlin.com](http://www.sames-kremlin.com)

**Azur™** range of pumps is the ultimate answer to people addicted to work, a reliable solution without compromising their painters efficiency.

#### STORAGE COMPARTMENT

- Built in the indestructible HDPE cover
- Store your parts and tips

#### PROVEN AIR MOTOR DESIGN FROM REXSON

- Pulsation free for stable fluid delivery
- Powerful suction capability
- Maintenance free

#### SELF ADJUSTING V PACKING

- No manual throat packing adjustment
- Increased sealing and piston life time

#### STAINLESS STEEL HYDRAULIC SECTION AS STANDARD

- Easy to maintain with quick disassembly
  - Large packing choice
- Minimal dead zone, no spring in contact with material & optimized for reduced waste

#### FOOT VALVE “ON-SITE” DESIGN

- Easy to access
- Reduced downtime

## 2 PRESSURES RATIO AVAILABLE

- 52/1, up to 312 bar (4525 psi)
- 72/1, up to 432 bar (6265 psi)

## EXTERNAL PNEUMATIC SWITCH

- Easy to access
- Icing free – no stalling



## VDE EXHAUST TECHNOLOGY

- Reduced icing potential
- Minimal noise pollution
- Stable paint supply

## EXTERNAL HP FILTER

- Easy to maintain or remove
- Reversible design
- Minimal dead zone

## FLAT FREE TIRES

- require maintenance free
- Small size for increased mobility

# OPERATION IN HARSH AND INTENSIVE CONDITION



**SnapPress**

Video of VDE technology

**NO FREEZING**

Venturi Dual stage Exhaust

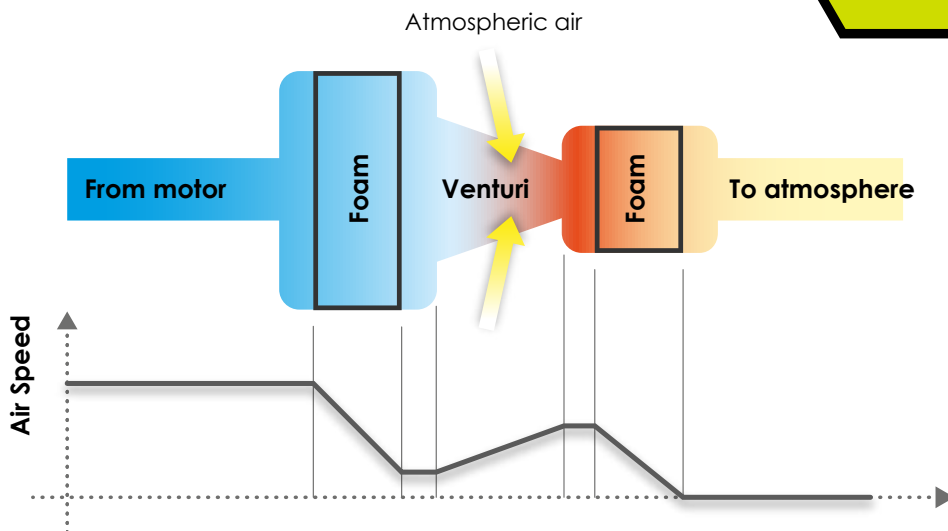

Heating exhaust air by the Venturi introducing ambient air

**Azur™** pump range ensures **constant application performance** in any conditions.

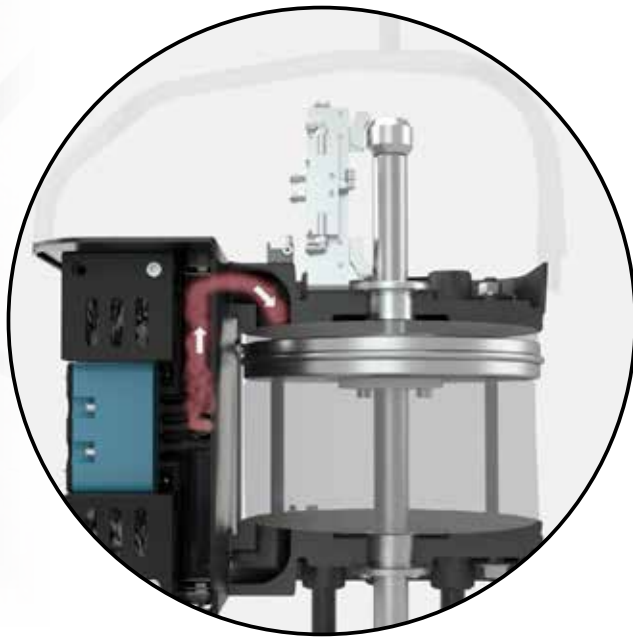

## **NO STALLING**

**Remote external switch:**  
Never in contact with moisture.  
The pump will always operate  
even if icing occurs.

## **NO LEAKAGE**

Choice of different packing  
compatible whatever  
material chemistry used.



# SIMPLE MAINTENANCE



SnapPress  
Video of Throat packing  
technology



**NO MANUAL  
THROAT PACKING  
ADJUSTMENT** **1**

Time savings

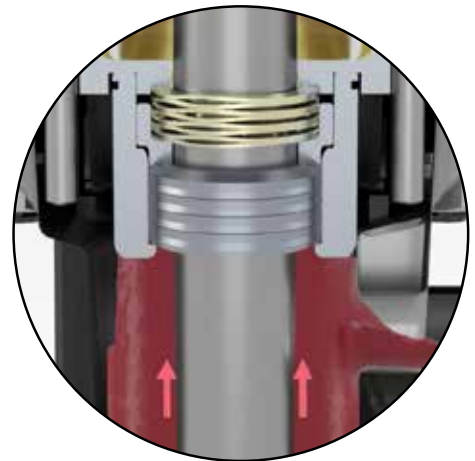
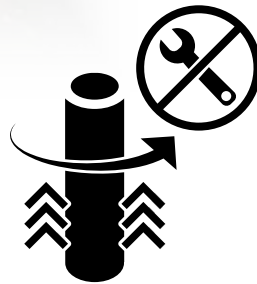

**NEW DESIGN  
ADAPT TO MALLET  
DISMANTLING** **2**

No tools required

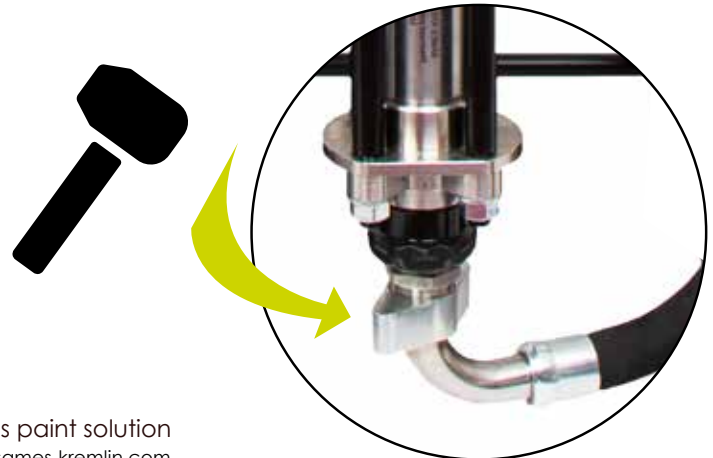

**Azur™** airless paint sprayer benefits:

- simple maintenance
- less components
- minimized operations to be carried out for daily use & maintenance



**3**

**INDEPENDENT  
FILTRATION SYSTEM**

Easy to flush - no dead zone & reversible design

**DIVORCE DESIGN  
FOR EASY ACCESS TO  
THROAT PACKING**

**4**



**5**

**EASY ACCESS TO FOOT  
VALVE DISASSEMBLY**

# COMFORT OF USE



**THE MOST SILENT AIR MOTOR OF THE MARKET\***

Minimum 22% less noise than competition

## Noise comparaison

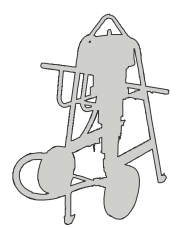
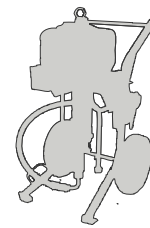

Model	Azur™ 52C225	Azur™72C160	Competitor 1 70-180	Competitor 2 60-240
Sound level (dbA)	77.5	72.5	92	83



**Azur™** solution maximizes the comfort of the operator by integrating:

## GUN ERGONOMICS

## MANEUVERABILITY

### EASY TIP ROTATION

- Fast tip unclogging even under high pressure

### BUILT IN HOOK

- Always keep the gun near the work station
  - Robust design

### LARGE EMBEDDED FILTRATION

- Filtering from inside to outside for easy extraction

### FATIGUE LESS TRIGGER

- Minimum 35% less effort than competition

### COMFORTABLE TWIST SWIVEL

- Fatigue free operation
- Possibility for direct connection



# SUPERIOR ATOMIZATION

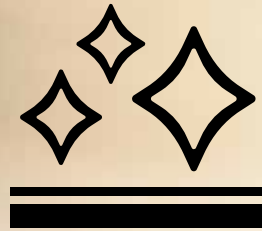
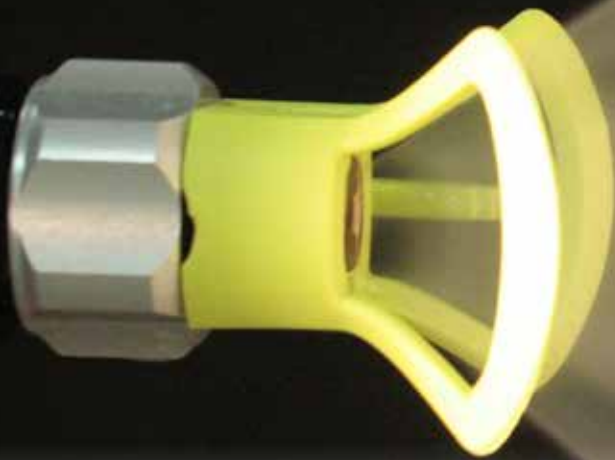

**Stable fluid supply** gives  
better spray finish

In addition, our **SFlow™** spray gun is embedded with a **dual diffuser technology** to perform the highest paint **finishing quality** (less re-work/re paint).

Our **air motor** is pulsation free, ensuring **stable fluid** delivery & **constant film** build.

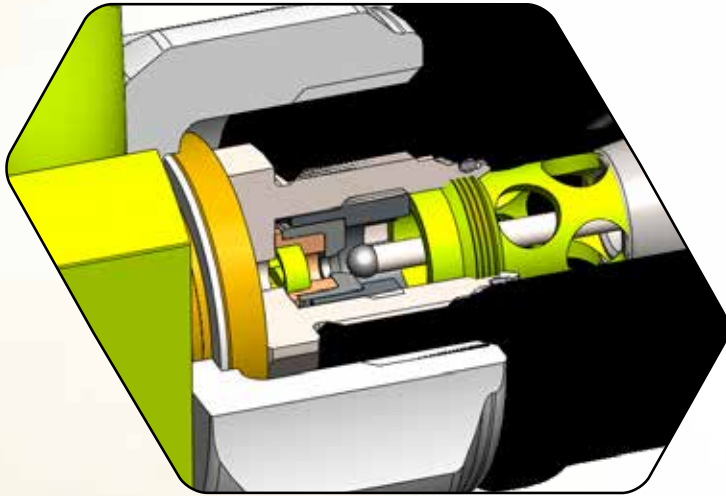

**1** **UNIQUE DUAL DIFFUSER TECH**

Internal diffuser & deflector pre atomizes the material before the spray tip, allowing lower atomization pressure & reducing overspray.

“ The SFlow™ Airless® spray gun is the perfect choice for us

- Mytec Ytbehandling AB (Sweden)



SFlow™ spray gun



# MARKETS

Protecting steel and concrete from corrosion, abrasion and weathering.



**Industrial**



**Marine**



**Bridge**



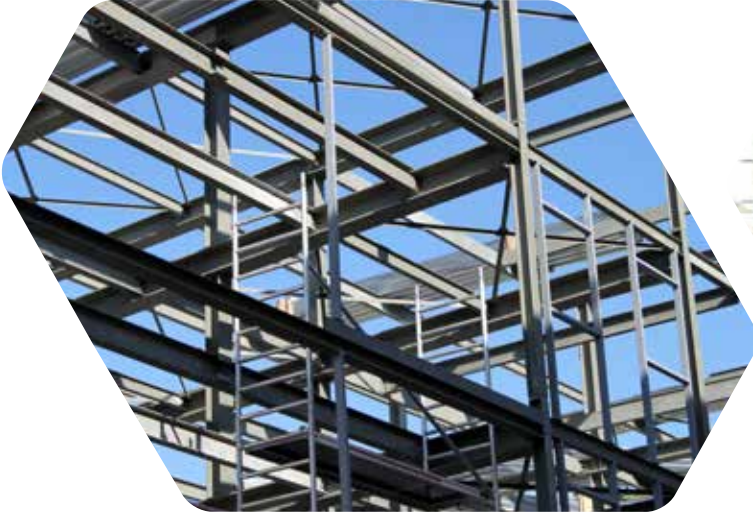

**Metallic  
Structure**



**Offshore**



**Buildings**

# ORDERING INFORMATION

Our protective coating equipment is modular, fitting all your needs. Please refer to the below chart to find your best combination.

## PUMPS AND PACKS CODES

### AZUR™ Pumps - Reference System

		Pump definition				Connection option			
		Range	Section	Material	Seals	Inlet	Control	Outlet	Stand
		ex: 6435	0160	1	3	1	1	1	5
Pump definition	Product Family								
	Azur™ Pump :	6435							
	Section type type								
	C225 :	0225							
	C160 :	0160							
Connection option	Hydraulic section material								
	Stainless stell body + Carbide Valves :	1							
	Seal package								
	UHMWPE + PTFE :	3							
	UHMWPE + Leather :	4							
	wUHMWPE + PTFE G :	5							
	Pump Inlet								
	None :	0							
	Suction rod ø1" - 30L :	1							
	Suction rod ø2" - 30L(1):	2							
Gravity hopper 20L capacity :	4								
Long suction rod ø1 - 200L(1) :	5								
Pump control panel									
None :	0								
Air motor regulation :	1								
Pump Outlet :									
None, outlet M3/8 NPSM(1) :	0								
Filter with 1 outlet 3/8 NPSM + 2nd plugged :	1								
Filter with 2 outlet M3/8 NPSM(1) :	2								
Priming kit :	7								
Pump stand									
Bare version :	0								
Wall Mounted assembly :	1								
Heavy duty trolley assembly :	5								

(1): Optional upon request, delivery time to be confirmed

## Technical data

Azur™	52C225	72C160
Output per cycle	225cc	160cc
Max. working pressure, bar (psi)	312 (4525)	432 (6265)
Max. air input pressure, bar (psi)	6 (87)	
Output per 30 cycle/mn, L (gpm)	6.5 (1.7)	4.8 (1.3)
ATE Marking	EX II 2G h IIA TX Gb	

## AZUR™ Packs - Reference System

		Pump definition				Connection option		Pack options			
		Range	Section	Material	Seals	Inlet	Outlet	Hose	Whip	Gun	
ex :		6435	0160	1	3	1	1	15	2	5	
Pump definition	<b>Product Family</b>										
	Azur™ Pump :	6435									
	<b>Pump type</b>										
	52C225 :	52225									
	72C160 :	72160									
	<b>Hydraulic section material</b>										
	Stainless stell body + Carbide Valves :	1									
	<b>Seal package</b>										
	UHMWPE + PTFE :	3									
	UHMWPE + Leather :	4									
	wUHMWPE + PTFE G :	5									
Connection option	<b>Pump Inlet</b>										
		None :	0								
	Suction rod ø1" - 30L(1) :	1									
	Suction rod ø2" - 30L :	2									
	Gravity hopper 20L capacity :	4									
	Long suction rod ø1 - 200L(1) :	5									
	<b>Pump Outlet :</b>										
	None, outlet M3/8 NPSM(1) :	0									
	Filter with 1 outlet 3/8 NPSM + 2nd plugged :	1									
	Filter with 2 outlet M3/8 NPSM(1) :	2									
	Priming kit :	7									
	<b>Gun type</b>	0 : None									
		5 : SFlow™ 470B with 519 tip (18-13) Tip Top									
	<b>Whip end hose</b>	0 : None									
		1 : 1m Polyamid 1/4" 1/4 NPSM(1)									
		2 : 1.6m Polyamid 1/4" 1/4 NPSM									
	<b>Main hose length</b>	0 : None									
		10 : 10m Polyamid 3/8" - 3/8 NPSM(1)									
		15 : 15m Polyamid 3/8" - 3/8 NPSM									
		30 : 30m Polyamid 3/8" - 3/8 NPSM(1)									

(1): Optional upon request, delivery time to be confirmed



### AZUR™ seal packs

Sealing can be critical on site. In order to fit to each application, we offer 3 different sealing packages.

Seal Package Choice		Selection Vriterias			
#	Seal kit	Chemical resistance	Mechanical resistance (abrasivity)	Temperature up to 60°C	Comment
3	UHMWPE + PTFE	★★	★★	★★★★	Good chemical compatibility. Ideal for premixed 2K material. Not ideal for abrasive material
4	UHMWPE + Leather	★★	★★★★★	★★	Entry offer for abrasive Solvent Based material(2)
5	UHMWPE + PTFE G	★★★★	★★	★★★★★	Solvent Based material. Lower the coefficient of friction and has excellent self lubricating properties. Good resistance to high temperature (up to 60°C)

(2) Please refer to chemical compatibility table

# ACCESSORIES

Come and discover our range of accessories that will compliment your **Azur™** pump.

We manufacture tungsten carbide airless tips to ensure repeatability of your applications in terms of flowrate and fan width AND to minimize your waste.



**SnapPress**

*Download part numbers list*

**Easy to plug – 2<sup>nd</sup> gun kit**

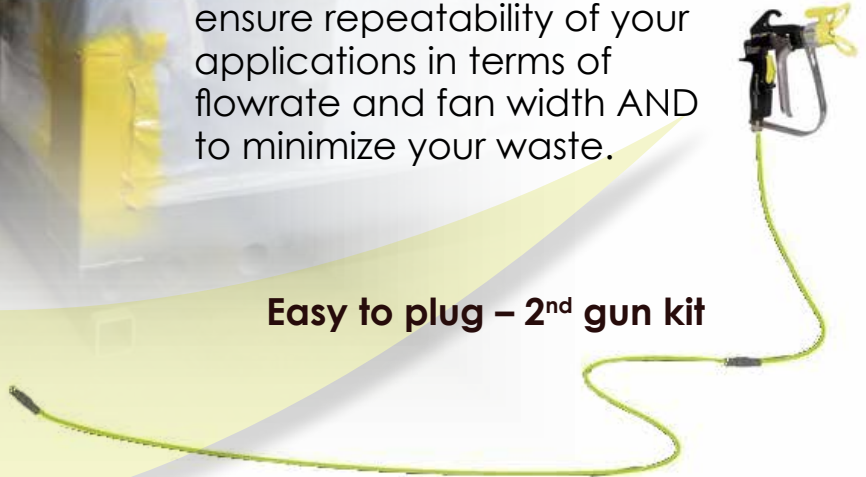

**Extension range for easier remote work**



**Large hose selection with various pressure rate and material**



**Premium reversible tip range called TIP TOP**



**Gravity hopper to increase suction capacity**



**Magma heater range to empower your application**



**Exhaust option with easy to prime kit**



# AIRLESS ADD-ON RANGE



OTHER HEAVY **AIRLESS®** PUMP  
AMONG MANY OTHERS



**35C50**  
Airless finishing application



**40C100**  
The good compromise



**80C220**  
The most powerful pump



## AUTOMATIC RANGE

### ASC

Compact by birth, Perform by choice



### AIRLESS®

For heavy material



## DOSING MACHINE

### AIRLESS®

Electronic dosing & mixing equipment

Plug & Spray solution pumping AND mixing 2 components material with adjustable ratio:

- Easy to use
- Always fresh material on demand
- Security of application



# GLOBAL PRESENCE

## 17 Locations

Worldwide

## 800 Employees

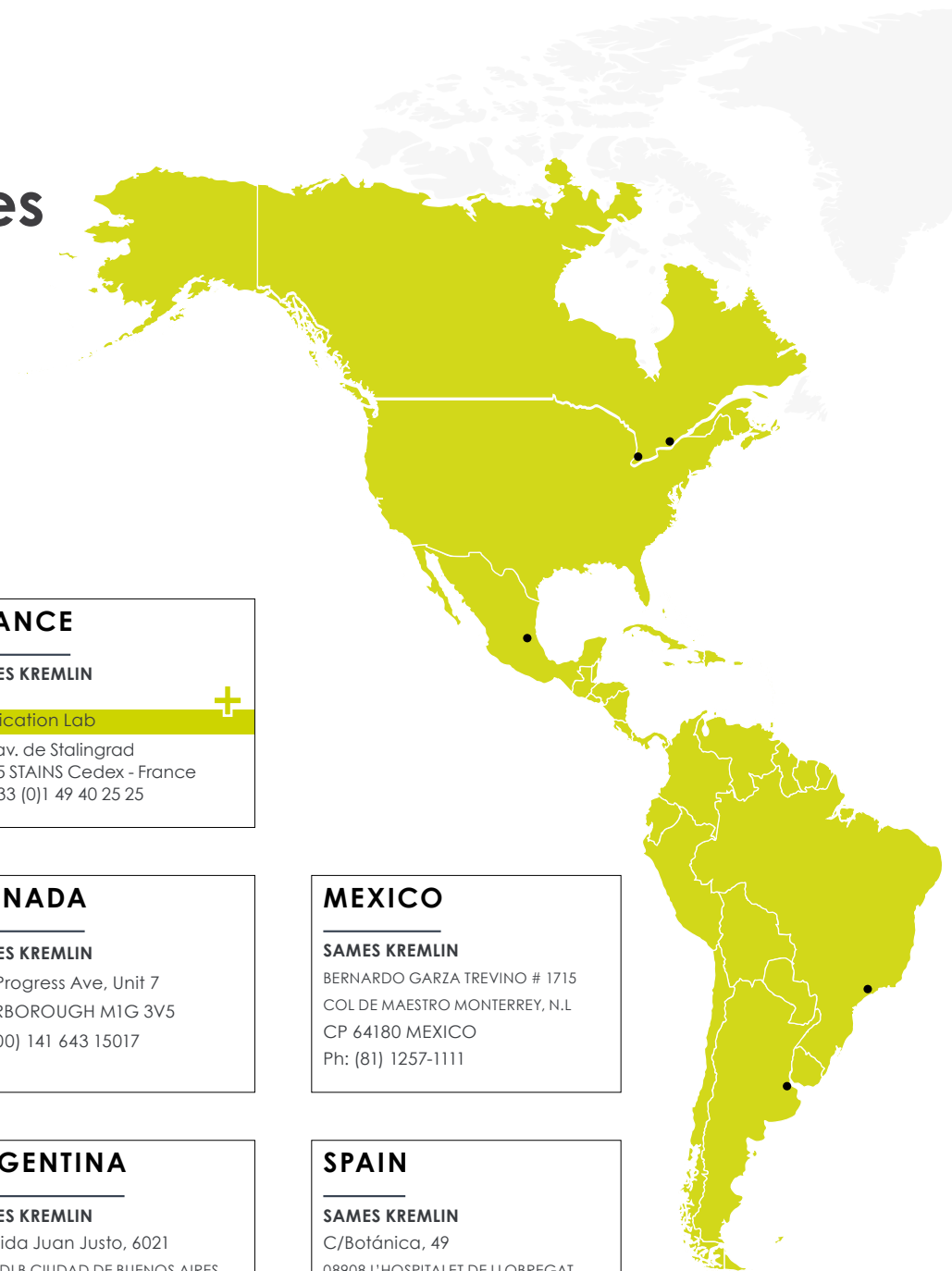

**FRANCE**

**SAMES KREMLIN**  
Headquarter 

Application Lab

13 chemin de Malacher  
38243 MEYLAN Cedex - France  
Ph: +33 (0)4 76 41 60 60

**FRANCE**

**SAMES KREMLIN** 

Application Lab

150, av. de Stalingrad  
93245 STAINS Cedex - France  
Ph: +33 (0)1 49 40 25 25

**USA**

**SAMES KREMLIN** 

Application Lab

45001 5 Mile Rd,  
PLYMOUTH, MI, 48170  
Ph: 734-979-0100

**CANADA**

**SAMES KREMLIN**

931, Progress Ave, Unit 7  
SCARBOROUGH M1G 3V5  
Ph: (00) 141 643 15017

**MEXICO**

**SAMES KREMLIN**

BERNARDO GARZA TREVINO # 1715  
COL DE MAESTRO MONTERREY, N.L  
CP 64180 MEXICO  
Ph: (81) 1257-1111

**BRAZIL**

**SAMES KREMLIN**

Rua Alfredo Mario Pizotti, N.41  
Vila Guilherme  
SAO PAULO SP  
Ph: (+ 5511) 2903 1200

**ARGENTINA**

**SAMES KREMLIN**

Avenida Juan Justo, 6021  
C1416DLB CIUDAD DE BUENOS AIRES  
Ph: +54 11 45 82 89 80

**SPAIN**

**SAMES KREMLIN**

C/Botánica, 49  
08908 L'HOSPITALET DE LLOBREGAT  
BARCELONA  
Ph: +34.932641540

**GERMANY**

**SAMES KREMLIN**

Moselstrasse 19  
D-41464 NEUSS  
Ph: +49 213 13 69 22 00

**GERMANY**

**INTEC SAMES-KREMLIN GmbH** 

High viscosity application Lab

Otto - Hahn - Allee 9  
50374 Erftstadt - Germany  
Ph: +49 (0)2235 46558 - 0

**ITALIA**

**SAMES KREMLIN**

Linate Business Park  
Strada Provinciale Rivoltana 35  
20096 Pioltello (MI)  
Ph: (+39) 02 - 48952815

# 1,000 Partners

Combining a total workforce of 10,000 people worldwide

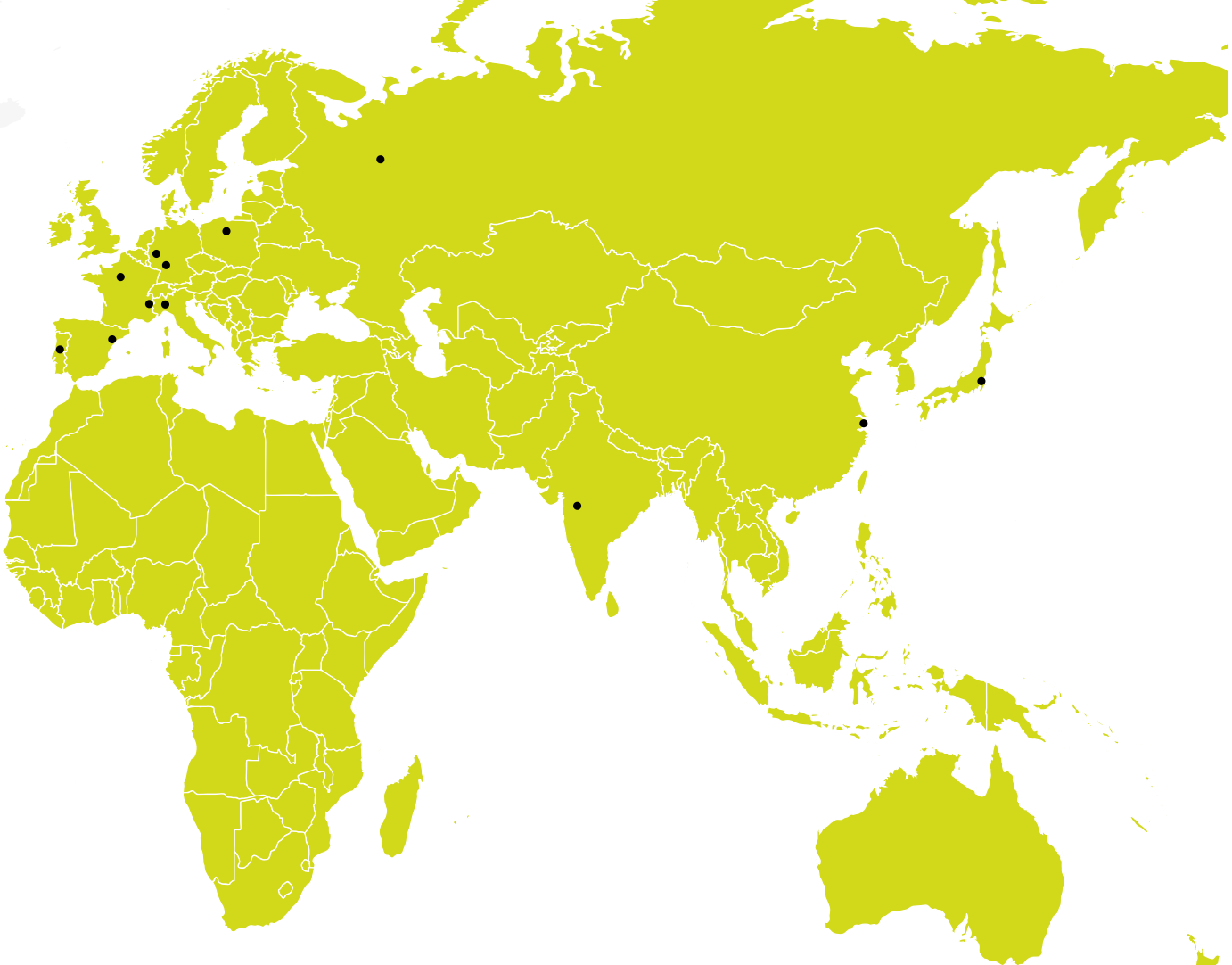

## POLAND

**SAMES KREMLIN**  
 Modlinska 221B  
 International Business Park #05-109E  
 03120-WARSZAWA  
 Ph: +48 225 103850

## RUSSIA

**SAMES KREMLIN**   
 Application Lab since the beginning of 2020  
 Rodionova str. 134.  
 603093, N. Novgorod - Russia  
 Ph: 007 831 467 8981

## CHINA

**SAMES KREMLIN**   
 Application Lab  
 Building No.9, No.3802 Shengang Road  
 Songjiang District  
 SHANGHAI 201613  
 Ph: 021-5438 6060

## PORTUGAL

**SAMES KREMLIN**  
 Rua da Silveira, 554 - Touria  
 2410-269 POUSOS LRA  
 Ph: +351 244 848 220

## INDIA

**SAMES KREMLIN**  
 GAT no - 634, PUNE NAGAR Road, Wagholi  
 PUNE - 412 207  
 Ph: +91 20 30472700/01

## JAPAN

**SAMES KREMLIN**  
 Takashima 2-19-12 - Sky Blig 20F  
 220-0003 YOKOHAMA - Nishi kanagawa  
 Ph: 045 412 5800  
 Mobile: 080 4203 3030

# Bond | Protect | Beautify

With our manual guns, automatic and robotic applicators, supplied by our wide range of pumps & machines for fluid handling, dosing, mixing & dispensing.

**SAMES KREMLIN** provides industrial solutions for production increase, quality improvement, material & cost savings.

We are designers and manufacturers of process equipment that is divided into **6 ranges**:

**Airspray:** Since 1925, we have been an airspray manufacturer bringing you the very best in finishing.

**Airmix®:** Creator of Airmix® Technology since 1975, we provide the perfect mix between quality and productivity.

**Airless®:** We provide premium Airless products for finishers with demanding applications.

**High Viscosity:** Pumping beyond possible, dispensing precisely.

**Electrostatic:** Expertise for high finishing quality & efficiency.

**Powder:** Powder coating solutions for the highest productivity since 1960.

FIND YOUR  
LOCAL CONTACT  
BY FLASHCODE:



[www.sames-kremlin.com](http://www.sames-kremlin.com)

Your new Augmented Reality content



SnapPress

1

Download the App on your smartphone or tablet  
(Free on the App Store & Google Play)



2

Scan the full page of the brochure when the symbol appears



3

Enjoy interactive hidden content

**SAMES**  **KREMLIN**

**SAMES-KREMLIN.COM**

**SAMES KREMLIN Inc.**  
North America Headquarters  
45001 5 Mile Road  
Plymouth, MI 48170  
Toll Free: (800) 573-5554  
Phone: (734) 979-0100  
Fax: (734) 927-0064

**SAMES KREMLIN Inc.**  
Canada Branch  
931 Progress Avenue, Unit 7  
Scarborough, Ontario M1G 3V5  
Toll Free: (800) 450-0655  
Phone: (416) 431-5017  
Fax: (416) 431-9171

**SAMES KREMLIN Inc.**  
Acceso III N°16A Int 15A  
Conjunto Quadrum  
Parque Industrial Benito Juárez  
Santiago de Querétaro, Qro.  
México, C.P. 76120  
+52 (442)209-5027 /161-2595 Ext 170