



From February 1st, 2017 SAMES Technologies SAS becomes SAMES KREMLIN SAS
A partir du 1/02/17, SAMES Technologies SAS devient SAMES KREMLIN SAS

SAMES  **KREMLIN**



User manual

Reciprocator Control Module REV 800 Operator Manual

SAS SAMES Technologies. 13 Chemin de Malacher -
Inovallée - CS 70086 - 38243 Meylan Cedex France
Tel. 33 (0)4 76 41 60 60 - Fax. 33 (0)4 76 41 60 90 - www.sames.com

Any communication or copying of this document, in any form whatsoever, and any use or divulging of its contents is forbidden without express written permission from SAMES Technologies.

The descriptions and characteristics contained in this document may be changed without prior warning and are in no way binding on SAMES Technologies.

© SAMES Technologies 2015



WARNING : Sames Technologies is registered as a "Training Center" approved by the "Ministry of Employment".
Trainings with the aim of getting the necessary know-how to use and for the maintenance of your equipment can be organised all along the year.
A catalog is available upon request. Among the different training programmes proposed, you will be able to find the training which corresponds the best to your needs and production purposes. These trainings can be organised in your premises or in our training center based in our headquarters in Meylan.

Training Department :
Tel.: 33 (0)4 76 41 60 04
E-mail : formation-client@sames.com

SAS Sames Technologies operating manuals are written in French and translated into English, German, Spanish, Italian and Portuguese.

The French version is deemed the official text and Sames will not be liable for the translations into other languages.

Reciprocator Control Module
REV 800
Operator Manual

1. Touch-sensitive Touch Panel - - - - -	4
1.1. <i>Using the Touch-sensitive Controls</i>	4
1.1.1. <i>Definition</i>	4
1.1.2. <i>Entry of Numerical Values</i>	4
1.1.3. <i>Buttons</i>	5
2. Main Menu - - - - -	6
3. Spray Tables - - - - -	7
3.1. <i>With simple part detection or without detection</i>	7
3.2. <i>With parts detection by cell barrier</i>	12
4. Automatic Mode - - - - -	14
5. Manual Mode - - - - -	15
6. Robot Configuration - - - - -	16
6.1. <i>Access to calibration</i>	16
6.2. <i>Calibration of the Axes</i>	17
6.3. <i>Definition of parts detection and robots</i>	19
6.4. <i>Configuration of start plan distance</i>	21
6.5. <i>Configuration of part detection by cells barrier</i>	22
6.6. <i>Configuration of conveyor speed</i>	23
6.7. <i>Advanced Spraying</i>	24
6.8. <i>Configuration of the Inputs</i>	25
7. System Configuration - - - - -	27
8. Faults and Status - - - - -	28
9. Appendices - - - - -	30

1. Touch-sensitive Touch Panel

Basic concepts

The screen of the Touch Panel shows the current operational status of the machine or plant. It is also used by the operator to control the course of the process by touching buttons and data entry fields.

1.1. Using the Touch-sensitive Controls

1.1.1. Definition

The touch-sensitive controls are touch-sensitive areas on the Touch Panel screen, including buttons, data entry fields and message windows. They are used in the same way as conventional keys. Press lightly on the touch-sensitive controls with a finger or other object.

Do not use sharp or pointed objects to operate the Touch Panel as these may damage the plastic surface of the touch-sensitive screen.



WARNING : Take care to only touch one point on the Touch Panel screen. Touching several touch-sensitive controls at the same time may result in unwanted operations being performed.

1.1.2. Entry of Numerical Values

Principle





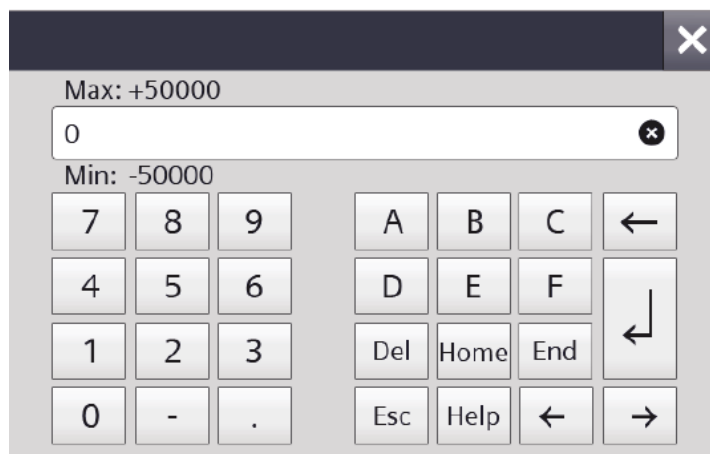

When entering numerical values, the Touch Panel automatically displays a numerical keypad as soon as a data entry field is touched. The active keys are shown in relief while inactive keys are shown as flat surfaces. The keypad disappears automatically when data entry is complete.

An example of a keypad used to enter numerical values is given below.



DES06306

1.1.3. Buttons

Button	Function	Purpose
	Move cursor to the left	Moves the current entry point one character to the left
	Move cursor to the right	Moves the current entry point one character to the right.
	Escape (ESC)	Cancels the data entry and closes the keypad.
	Enter	Confirms the data entry and closes the keypad.
	Show Help page	Displays the appropriate Help page.
	Suppression of the character to the right	Deletes the character to the right of the cursor.
	Backspace	Deletes the character to the left of the cursor.

ES06307

2. Main Menu

Main Menu view

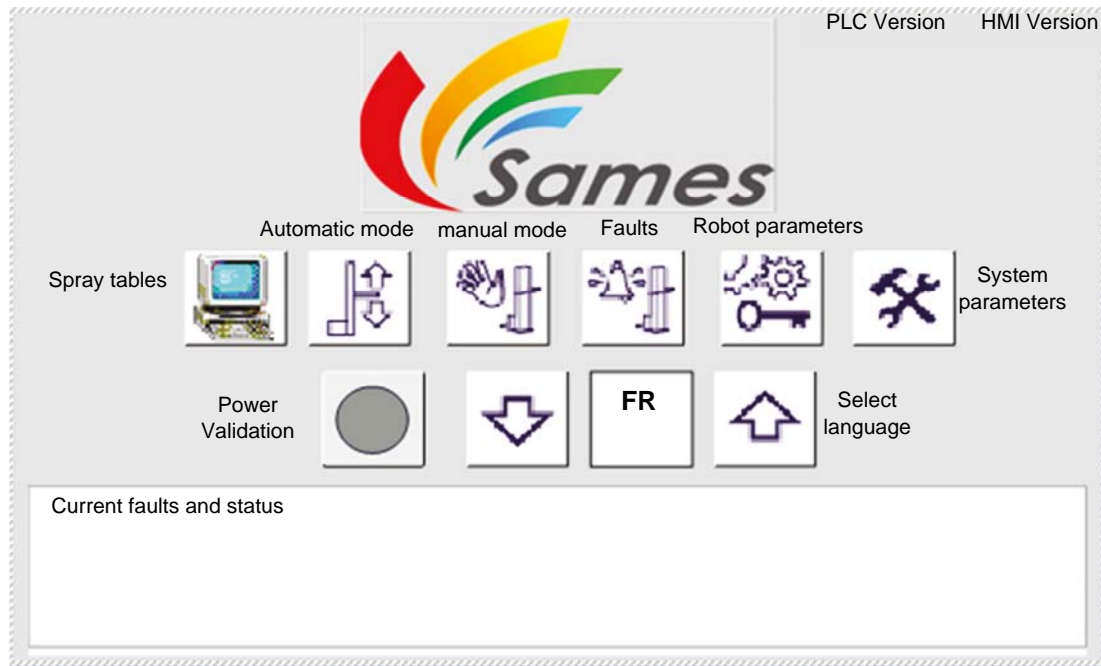

The **spray table** for a robot contains all the programmed trajectories.

Up to 20 different tables may be specified for each robot.

The spray tables contain parameters controlling movement, spraying and parts simple detection.

The **Automatic mode** view is used to start the oscillation of a robot in accordance with a spray table.

The **Manual mode** provides access to the individual movements of each robot and control of the triggers.

The **Faults and status** shows the current faults and status of the robots. The status or the latest fault is shown at the bottom of the screen.

The **Robot parameters** are used to configure the robots, including calibration, advanced triggering, parts detection, conveyor speed, input direction, etc.

The **System parameters** view enables to user to adjust the contrast, calibrate the screen, and disable the touch-sensitive panel for cleaning. Other system parameters may be accessed using a SAMES configuration unit.

The **power validation button** allows to validate the power on robots drives once the circuit breaker switch has been turned ON.

Select language (there are five available languages)

- French FR
- English GB
- German DE
- Italian IT
- Spanish SP

3. Spray Tables

The spray table view varies according to the number of robots to be configured and the type of parts detection.

3.1. With simple part detection or without detection

Type selection view for two robots

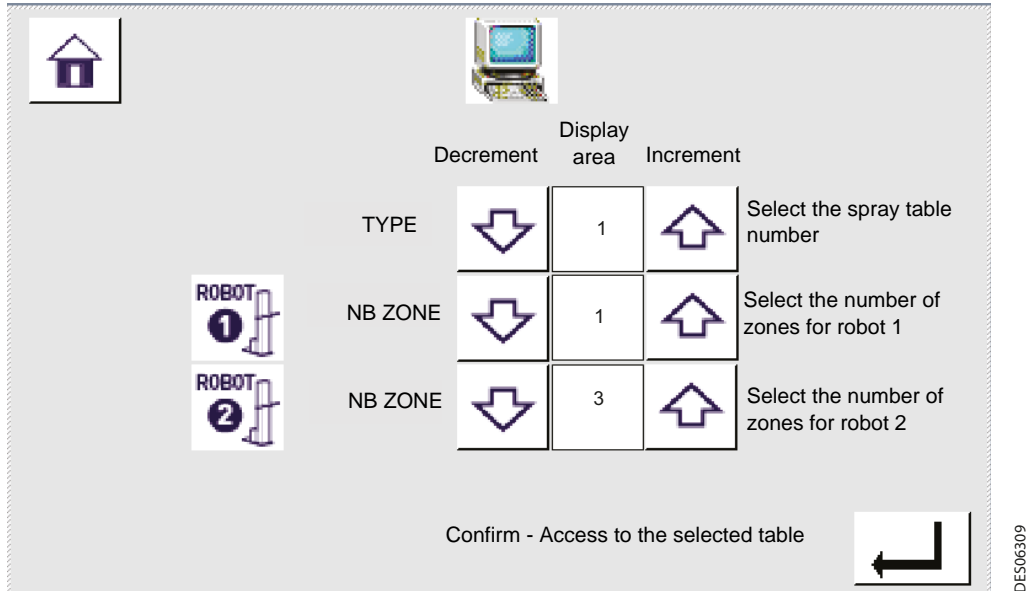

If only one robot is selected, the line associated with robot 2 does not appear on the screen. The number of zones for a given robot may vary within a single type.

- Number of types: 1 to 20
- Number of zones: 1 to 3

The spray tables are accessed and modified in operation.

When the view has been confirmed, the display shows spray table N°1 for robot 1:
Spray table for robot N°1 view

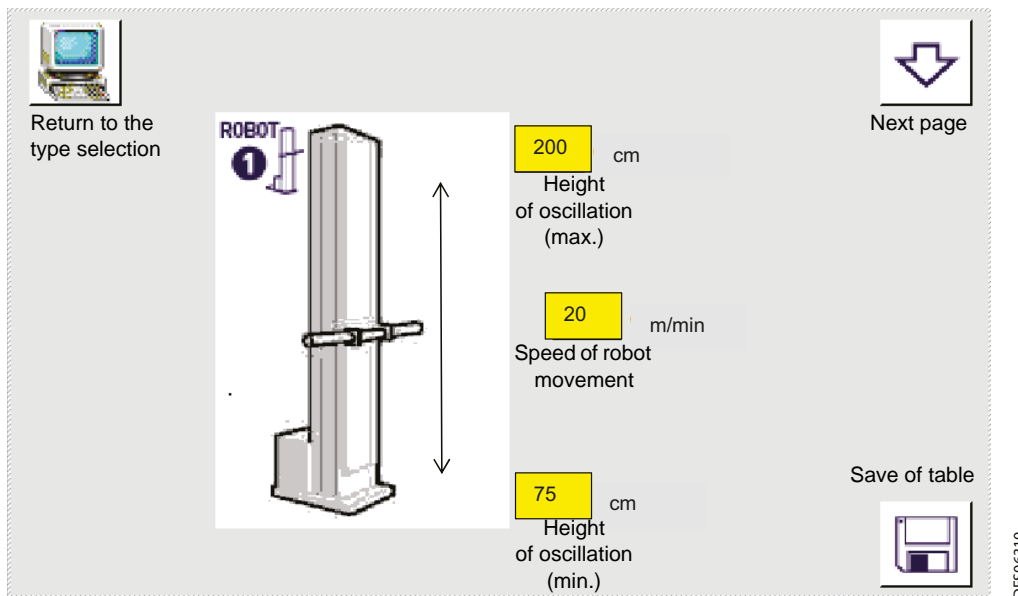

This table consists of a single zone, and spraying is enabled by default.

Note: To position the robot, set the speed to zero and enter the required position for the minimum marker.

Recommended minimal value: 5 m/mn (16 feet/min).

Speed of movement: 0 to 60 meters/minute or 192 feet/min for a liquid paint robot.

0 to 25 meters/minute or 80 feet/min for a powder paint robot.

The oscillation height is set as an integral number of centimeters, measured between the ground and the position of the trolley.

In general, the oscillation height must remain greater than the minimum calibration value in centimeters and less than the maximum calibration value in centimeters.

If incorrect values are entered, a default table is shown and the display returns to the Select spray table view without making any changes to the parameters.

If the Next page button is touched, the display shows

the spray table for robot N°2 (providing two robots have been selected)
or to the detection timing parameters page, if detection has been selected.

Spray table for robot N°2 view with 3 zones

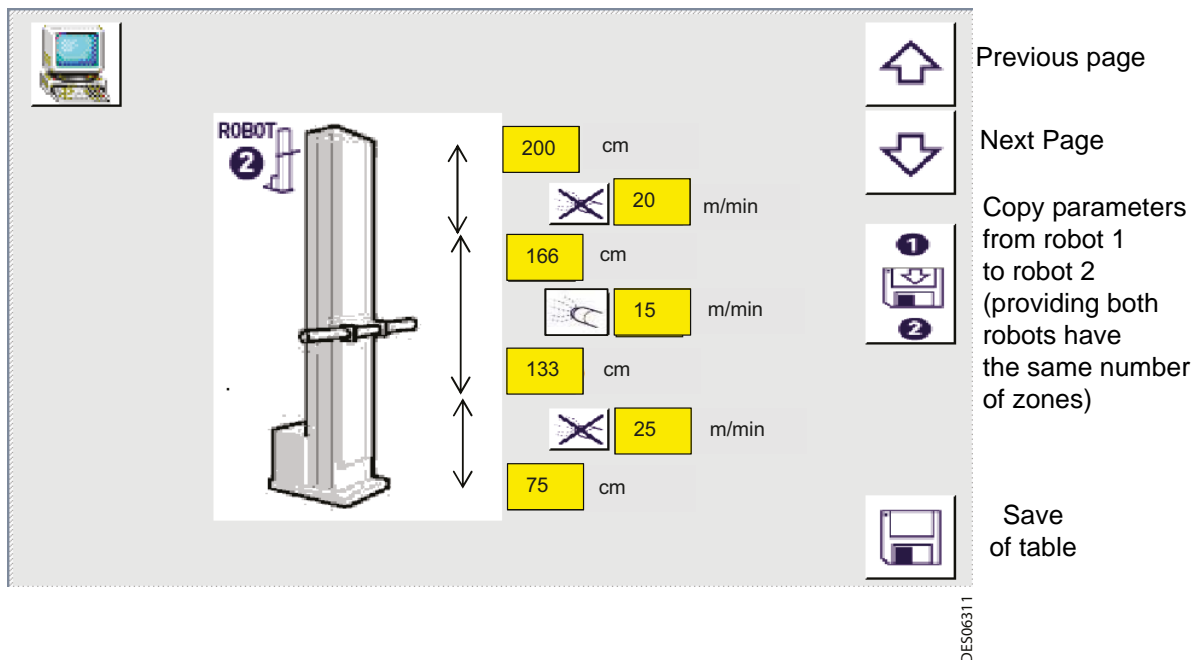

The movement parameters consist of two change of direction points for the oscillation movement, the number of zones (with the height of the markers) and the speed in each zone. The zones break down the oscillation into greater detail.

For example:

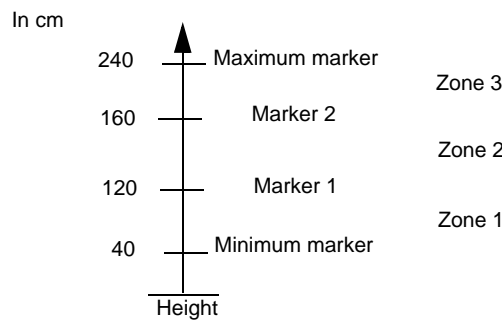



WARNING : According to the speed adjustment (m/min) and zone (cm), the movement being carried out can be different from the requested movement. Indeed, the system has to leave time to the axis to thoroughly carry out its accelerations and decelerations (0,3 sec).

Example: for a speed of 60 m/min (= 1 m/sec.), the deceleration or acceleration distance is approximately of 33 cm.

Previous page: Return to the spray table for robot 1

Next page: Access the Spraying parameter view (if simple detection is enabled).

Once the parameters for the spray table for robot 1 have been entered, a **Copy function** is available to copy these parameters to robot 2, provided that the values are valid and both robots have the same number of zones.

Spray enable enables spraying in the zone subject to the detection parameters if 3 zones are defined.

Save: When the spray table is complete with consistent and valid data, touching one of the Save buttons saves the currently displayed table into the memory space allocated to the type. If the table concerned is currently being executed, the new values are applied to the robot immediately.

Touching the Save button returns the screen to the Select type view.

If any of the table data is not valid, a Fault view warns of an inconsistency in one or more of the tables.

Spray table fault view:



If any of the table data is not valid when the Save button is touched, a Fault view error message is displayed.

(e.g. Minimum marker > Maximum marker)

The validity of each parameter entered into the tables for robots 1 and 2 is checked.

5 pre-programmed spray tables are available containing the following parameters:

Description		Type 1	Type 2	Type 3	Types 4 to 5
Number of zones	Between 1 and 3	1	2	3	1
Minimum marker	In cm	75	75	75	75
Maximum marker	In cm	200	200	200	200
Marker 1	In cm		150	133	
Marker 2	In cm			166	
Speed 1	In m/min	20	20	20	20
Speed 2	In m/min		15	15	
Speed 3	In m/min			20	
Upstream part width	In cm	5	5	5	5
Downstream part width	In cm	10	10	10	10
Trigger 1	YES/NO			NO	
Trigger 2	YES/NO			YES	
Trigger 3	YES/NO			NO	

Touching the Next page button provides access to the detection timing parameters.

Timing parameters view:

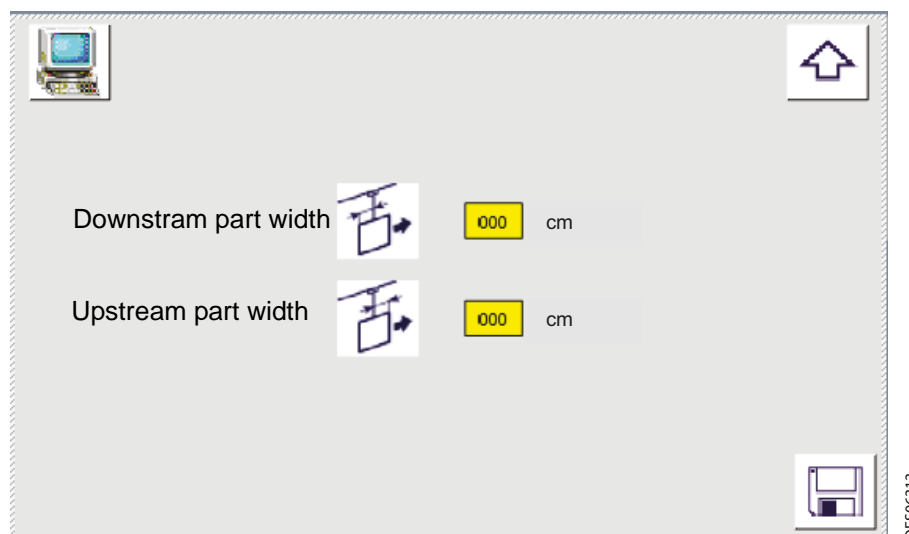

If detection is enabled, a window will be displayed when the data for robots 1 and 2 has been entered, this next page is used to enter width of the part to be coated.

Upstream/downstream part width: according to the detection point of the part, these parameters allow to proportion the width of the part. It is possible to set up a width of the part. It is possible to set up a width of part for each type. See possible scenario:

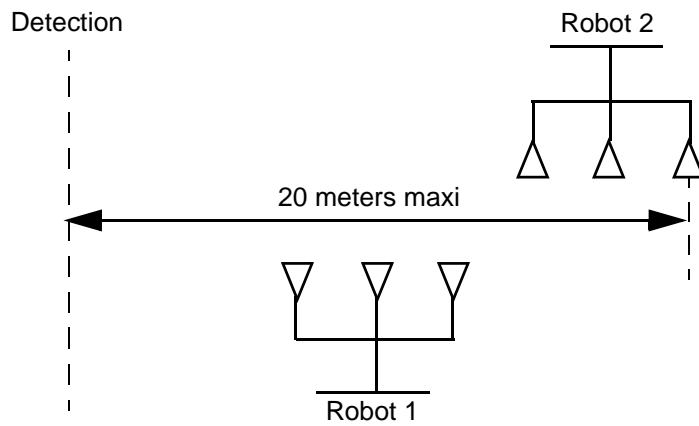

Detection and the follow up of parts : the follow up of parts is managed on 20 meters long as on the picture here above. During this follow up, the REV 800 manages spray breaks between parts

Possible scenario according to detection :

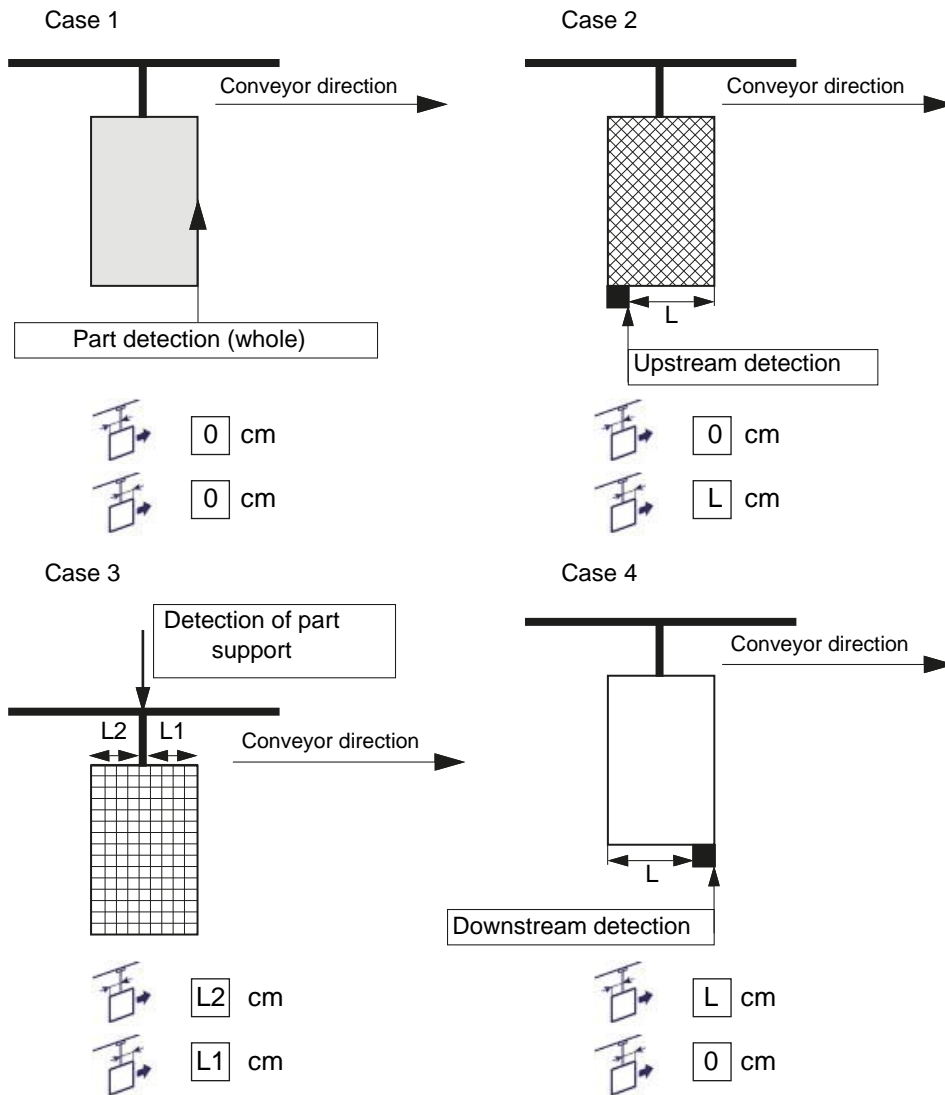

DES02744

3.2. With parts detection by cell barrier

In this case there is a single area of oscillation so the zone selection menu does not appear.

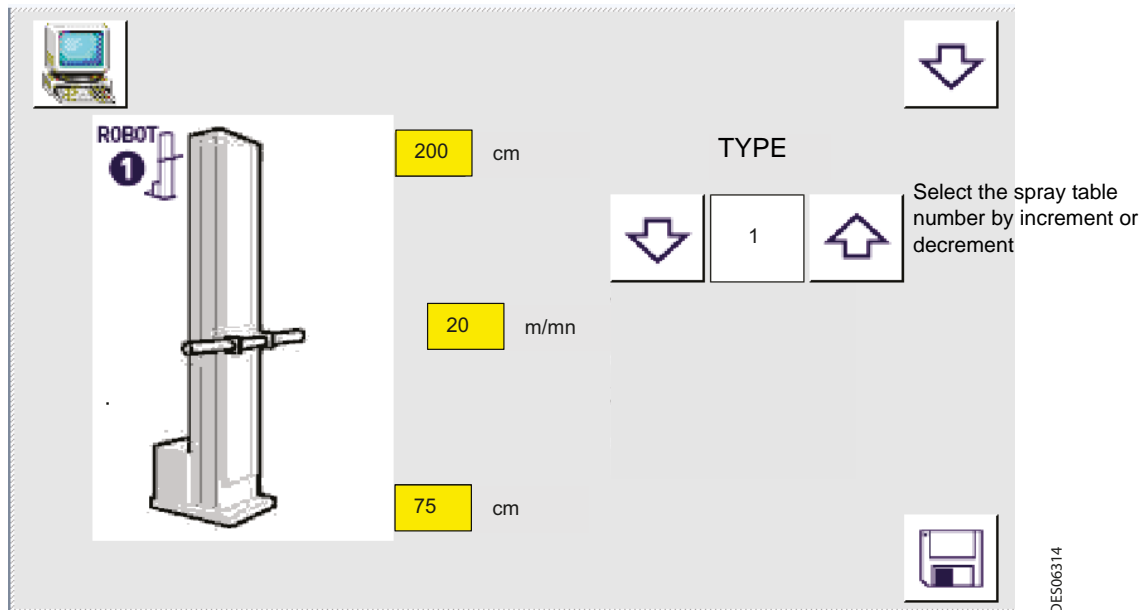

If two robots were declared (in the Robot configuration menu)

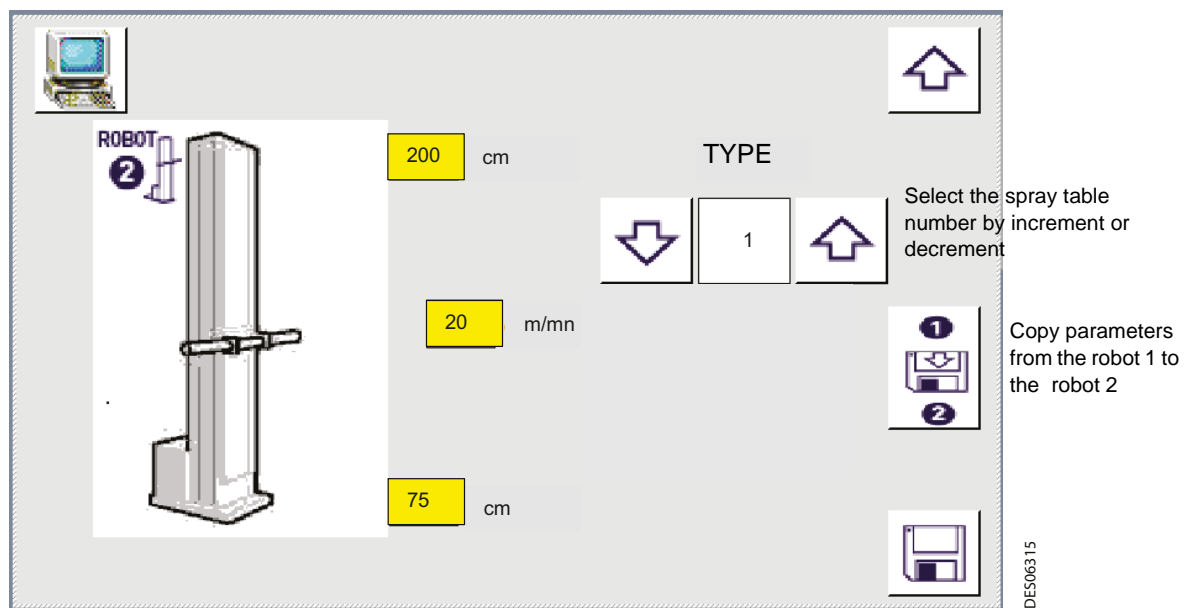

Touching the Next page button provides access to the detection timing parameters.

Timing parameters view:

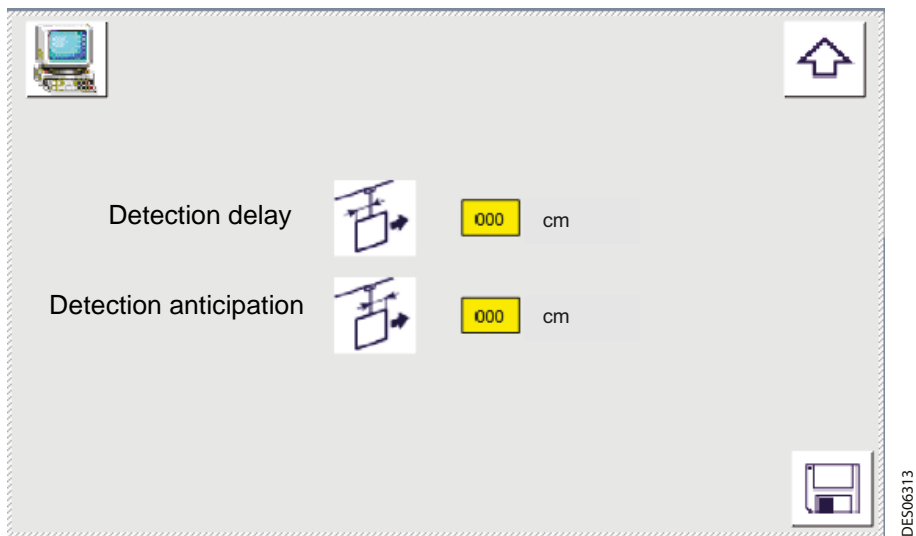

If detection by barrier cell is enabled, a window will be displayed when the data for robots 1 and 2 has been entered, this page allows to fix anticipation and delay in taking into account detection and therefore spraying.

For each sprayer defined by plan, spraying will start earlier taking into account the detection anticipation and will end later taking into account the detection delay relative to the distance of each plan.

4. Automatic Mode

The process may be run in automatic mode if no manual mode command is currently in progress (robot selector OFF).

The change of mode occurs immediately, even if the robot is currently in operation. In the same way, if a spray table is currently being executed, saving any modification to the spray table takes effect immediately.

Automatic mode view

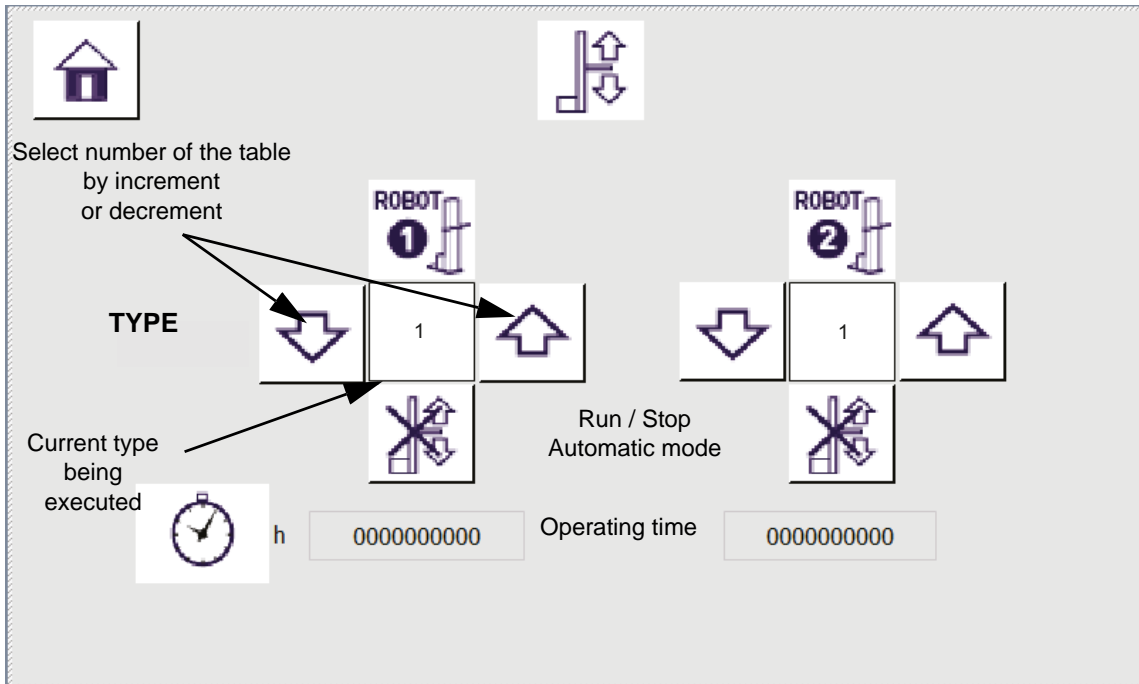

Operating time (in hours): This is the total cumulative operating time including operation of oscillation in both automatic and manual modes.

Select type: It is possible to select a type of spray table between 1 and 20.

5. Manual Mode

Using the Manual mode view, it is possible to control certain actions of the robot, providing that no robot is currently in automatic mode.

All the actions are applied to the selected robots. Deselecting a robot terminates all current actions on that robot.

Manual mode view:

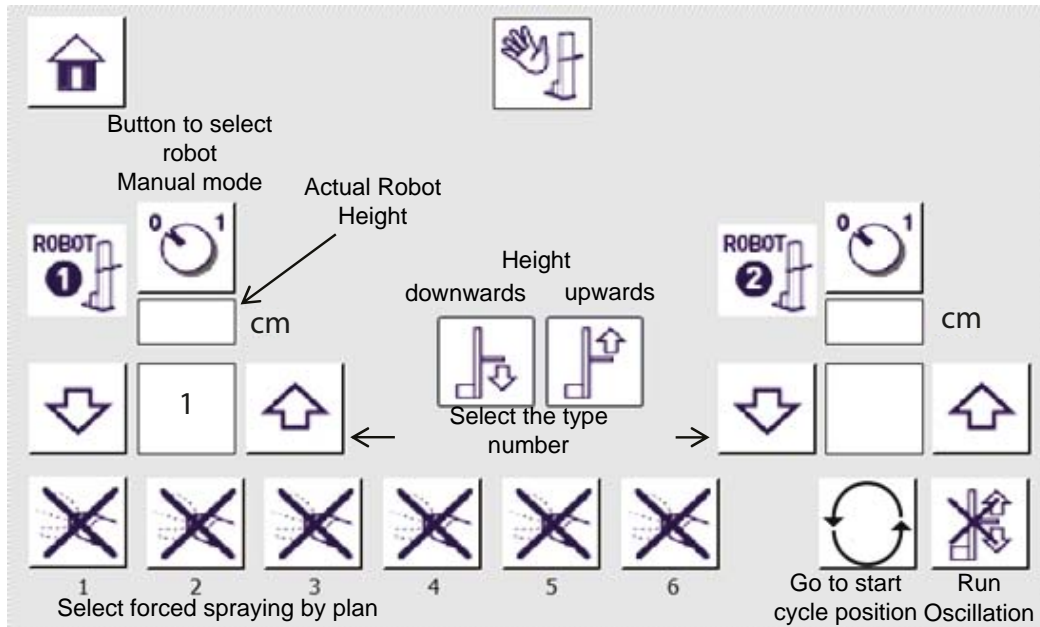

Actual robot height: This shows the actual robot height in centimeters as it is moved up and down. This is the value of the potentiometer in Volts converted into centimeters. (See robot configuration view)

Manual mode robot button: When this button is set to a '1', all the manual mode functions at the bottom of the view are enabled. To switch to automatic mode this selection must be disabled.

Select type number: The arrow keys are used to select the number corresponding to a spray table so that it can be executed in manual mode.

Run oscillation: Touching this button starts the movement defined by the selected spray table and type.

Plan number: Each robot can spray in one of six plans corresponding to the offset between the sprayers and the axis of the conveyor. The first plan in the direction of travel of the conveyor is N°1 and the last plan is N°6. There may be between 1 and 6 plans depending on the configuration. (See robot configuration view).

Select forced spraying: Touch the button corresponding to the required plan number to activate the triggers associated with the plan (see robot configuration view). Manual movement along the height axis: Hold the **Move downwards** or **Move upwards** button to move the robot in the required direction. For safety reasons, the movement stops immediately when the button is released.

Go to start of cycle position: Touching this button causes the robot to move to the programmed start of cycle position. (See robot configuration view)

6. Robot Configuration

The robot configuration views are accessed by touching one of the corresponding keys in the Main Menu.

6.1. Access to calibration

This view gives access to the calibration view and allows changing unit from cm into inches.

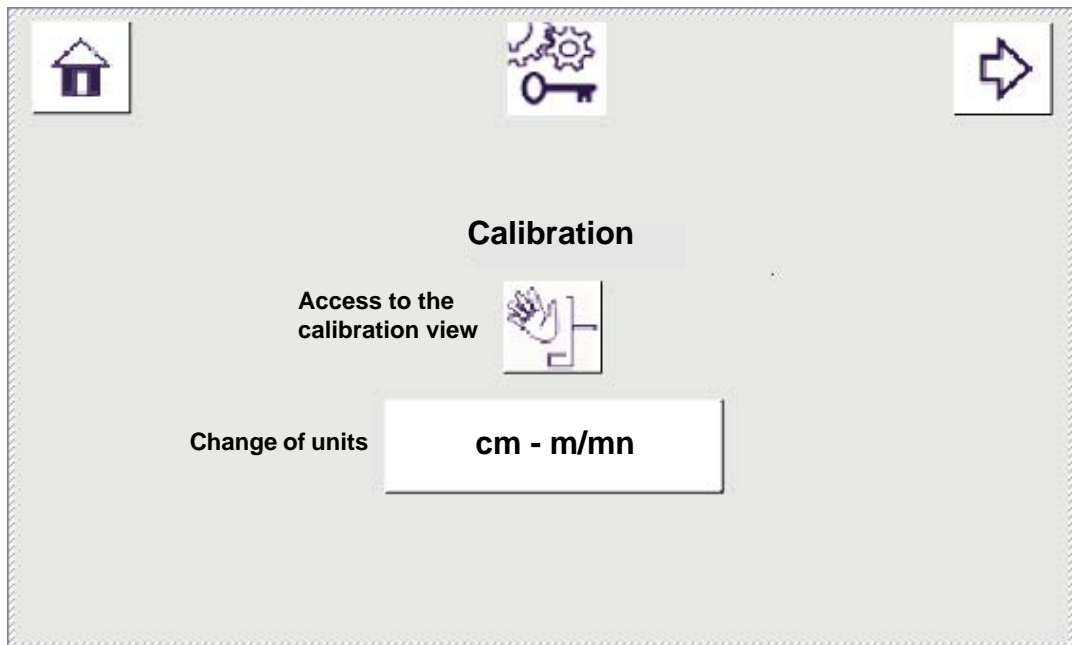

"Calibration": this button gives access to the axes calibration view. When pressing this button, the robot stops and its axes are electrically released.

"Conversion": this button allows to change the units of the "REV 600"; i.e. to pass from the units of the international system (IF) to the ones of the US and vice and versa.



WARNING : The values in the spray tables are not converted between metric and Imperial measurements.

Only the calibration values are converted, for example:
280 cm --> 110 inches, 65 cm --> 25 inches.

6.2. Calibration of the Axes

Calibrating the vertical axes of a robot defines the minimum and maximum limits of travel and converts the potentiometer data to a value in centimeters.

This calibration must be carried out and an initial default calibration is performed on each axis.

The default values for a standard RFV 2000 robot are 65 cm and 280 cm between the trolley attachment point and the ground.

Calibration view:

The screenshot shows a calibration interface for a robot. At the top, there is a gear and key icon, and a button labeled "Next view of robot configuration" with a right-pointing arrow. Below this, there are two robot icons labeled "ROBOT 1" and "ROBOT 2". The interface is divided into two columns for "MAX" and "MIN" settings. For "MAX", the unit is "cm" and the value is "280". For "MIN", the unit is "cm" and the value is "65". Below these, there are two columns for "HEIGHT" with units "cm" and "Pts", showing values "65" and "2491". The text "Actual robot height in cm et in points" is at the bottom. On the right side, there is a vertical label "DES06319".

Setting	Unit	Value	Action
MAX	cm	280	Save maximum calibration value
MIN	cm	65	Save minimum calibration value
HEIGHT	cm	65	
HEIGHT	Pts	2491	

Actual robot height in cm et in points

Actual height position: This shows the actual height of the robot as it is moved.

Actual value at the maximum calibration point: When the robot is positioned at the highest required value, the actual value in centimeters measured between the ground and the sprayer (or the mean center of the sprayers) is entered.

Actual value at the minimum calibration point: When the robot is positioned at the lowest required value, the actual value in centimeters measured between the ground and the sprayer (or the mean center of the sprayers) is entered.

Save maximum calibration: Positioning the machine at the highest position required and entering the actual value in centimeters calibrates the maximum point on the axis. The readout from the potentiometer in Volts is associated with the actual measured value in centimeters. This also defines the maximum limit of travel. A control fault is reported if this level is exceeded.

Save minimum calibration : Positioning the machine at the lowest position required and entering the actual value in centimeters calibrates the minimum point on the axis. The readout from the potentiometer in Volts is associated with the actual measured value in centimeters. This also defines the minimum limit of travel. A control fault is reported if this level is exceeded.

Calibration procedure:

Connect and apply power to the system.

- **Step 1:** Move the robot manually to the minimum position.
- **Step 2:** Measure the height in centimeters and enter the value.
- **Step 3:** Confirm by touching the Save minimum calibration button.
Check that the height displayed in cm and point is consistent.
- **Step 4:** Move the robot manually to the maximum position.
- **Step 5:** Measure the height in centimeters and enter the value.
- **Step 6:** Confirm by touching the Save maximum calibration button.
Check that the height displayed in cm and point is consistent.

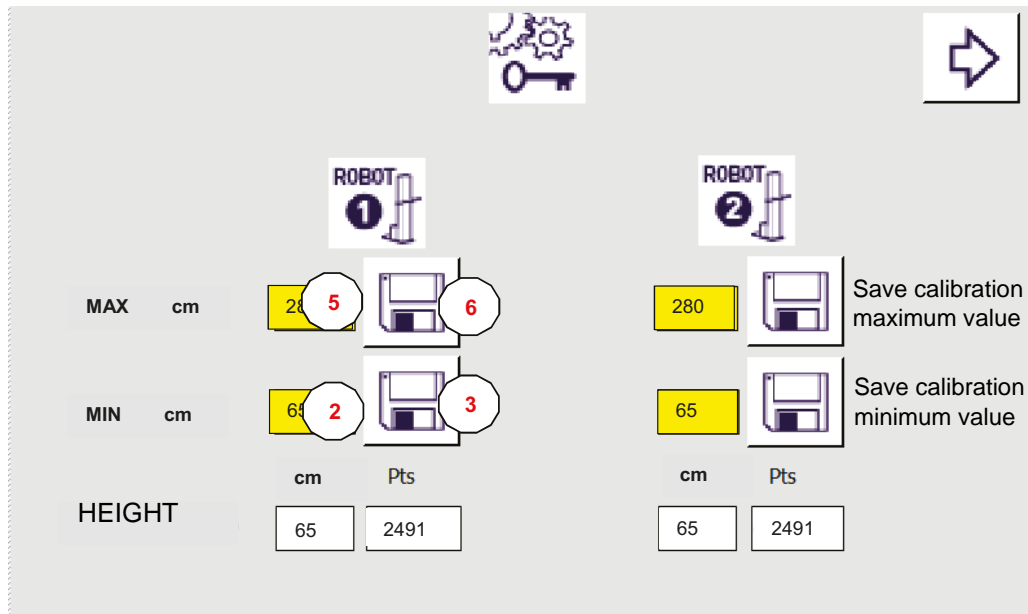

After calibration, the REV 800 is continually aware of the actual position of the robot and is able to carry out the programmed movements correctly.

The raw positional data is provided in Volts (0-10V) by a rotational potentiometer. The corresponding position in centimeters is given by the expression $Y=aX+b$. The two coefficients are calculated from the calibration data at the two limit positions.

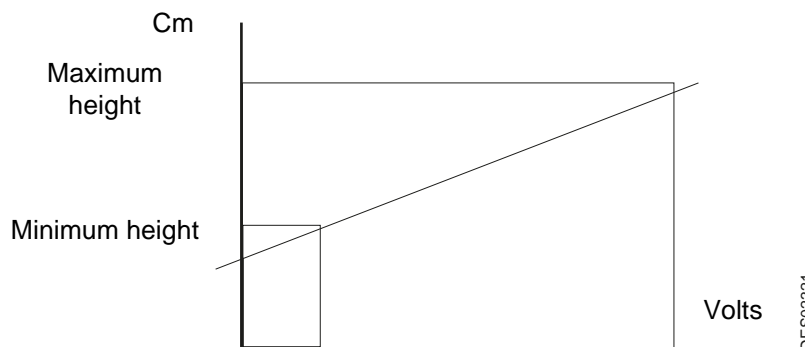

Maximum position (extent of travel) = Maximum calibration position – Safety offset (1 cm).

Minimum position (extent of travel) = Maximum calibration position + Safety offset (1 cm).

When delivered, the REV 800 is programmed with two standard coefficients corresponding to an RFV2000 robot with a travel of two meters. However, the calibration procedure must be carried out during commissioning and following any maintenance operation involving either the potentiometer or the transmission.

Touching the right arrow key displays Parameter view N°2.

6.3. Definition of parts detection and robots

The view is used to configure:

- The type of parts detection
- The type of robot (powder or liquid)
- The type of stroke in a powder and detection barrier configuration
- The start of cycle position
- The number of robots selected

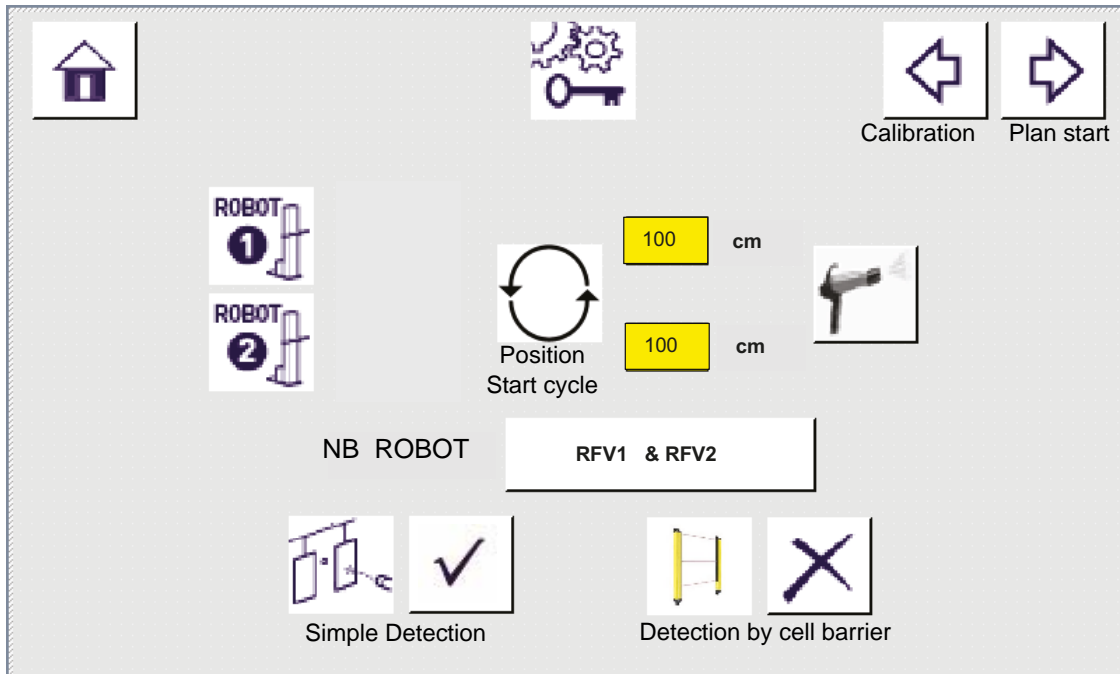

DES06321

Select the number of robot: This is a binary selection. There is always either one or two robots. After changing, the user must return to the previous view and come back to this view to refresh it.

Selection of the type of RFV robot



Selection RFV version powder.
The speed range of the robot is then between 5 and 25 m/mn.



Selection RFV version liquid paints
The speed range of the robot is then between 5 and 60 m/mn.

Programmed height of the start of cycle position: This is the position of the robot when it is not oscillating in automatic mode

The last line is used to configure the operating mode:

Without detection. The sprayer triggers are actuated as soon as the robot is set to automatic operation. Spraying is continuous while the conveyor is in motion.

With simple detection. Spraying is timed with reference to the first or last part. The timings are specified in the spray tables according to the type. The timings depend on the conveyor speed and the distance between the robots and the detector sensor.

With detection by cells barrier, the oscillation zone can be divided into six spray zones. In each zone there is associated a spray authorization.

Spraying is associated with the activation of the part detection in each of the areas defined in the barrier cells and taking into account the conveyor speed and distance between the robots and the detection sensor.

Note: To enable detection by cells barrier, the simple detection must first be disabled.

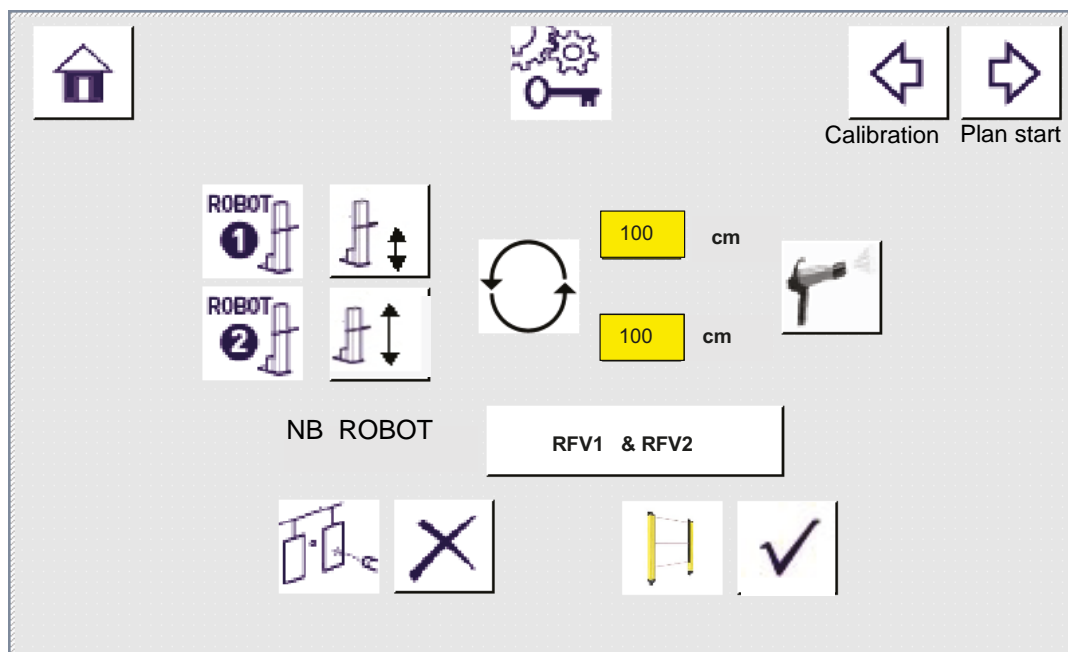

DE506322

In powder robot with detection barrier, there are two modes of application:

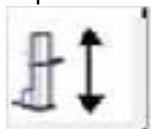

The robot sweeps over a spraying **large stroke** and according to the zone occupation of the cell barrier, the trigger of the sprayer activates (equivalent to a liquid application)



The robot sweeps over a **short stroke** with several sprayers which cover the entire zone, and an occupation zone of the barrier is allocated to each sprayer.

The robot 1 may be in short stroke configuration for driving CRNs and the robot 2 can be big in large stroke configuration to drive a TCR.

6.4. Configuration of start plan distance

"Start plan distance " view:

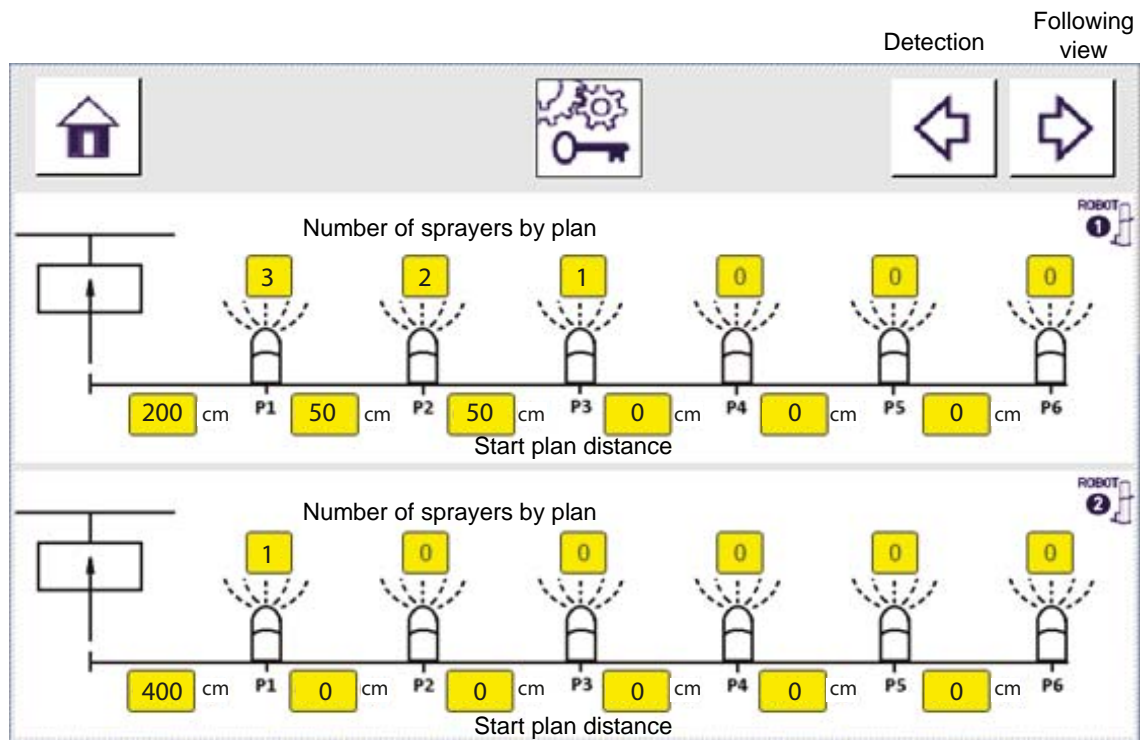

Start plan distance : distance between detection device (cell, stroke end, ...) and axis of the first sprayer of robot (P1). The maximum value is 1500 cm.

Plan 2 distance : distance (P1, P2) between the first and the second group of sprayers installed on the robot. The maximum value is 250 cm.

...

Plan 6 distance : distance (P5, P6) between the fifth and the sixth group of sprayers installed on the robot. The maximum value is 250 cm.

For each plan the **number of sprayers** installed is defined with a maximum of 6 sprayers by plan and 6 sprayers by robot.

In the example, 3 sprayers are installed on the plan 1 at 200 cm from the detection and 2 sprayers are installed on the plan 2 at 50 cm from the plan 1 and one sprayer is installed on the last plan to 50 cm from plan 2 of the robot 1. One sprayer is mounted on the robot 2 at 400 cm from the detection.

Notes :

Only used plans and sprayers must be configured.

In case of constant spraying (without part detection), the number of sprayers to activate must be configured at the plan 1 (with a distance set to 0)

If two triggers are needed for a given sprayer, two sprayers must be configured (case of use with an SLR cabinet for example with a spray trigger and a HV trigger).

Since the PLC/ HMI version V1.5 there are 6 plans instead of 3.

6.5. Configuration of part detection by cells barrier

The configuration of the occultation zones of the cells barrier is not managed by the REV 800 module. This setting is done by the programming software of the detection barrier. However it is necessary to copy this configuration in the following pictures when the barrier sensor is activated.

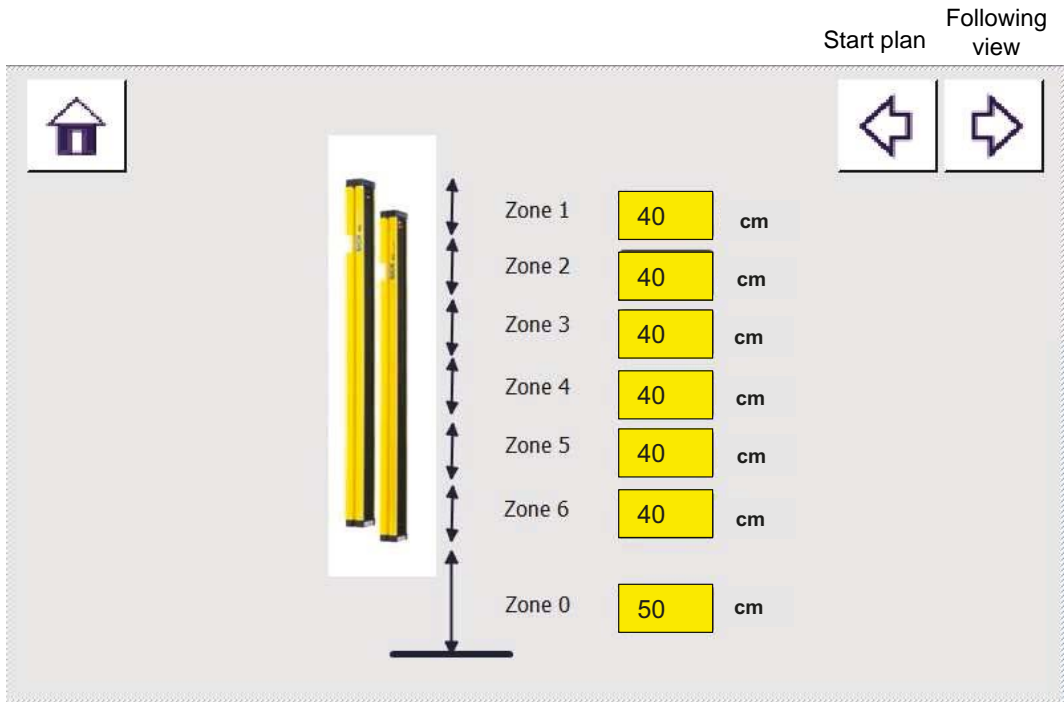

DES06324

Up to 6 occultation zones (zone 1 to 6) can be defined for the cells barrier.

If either or both robots are in powder **short-stroke** configuration an occultation zone must be assigned to each sprayer of the concerned robot.

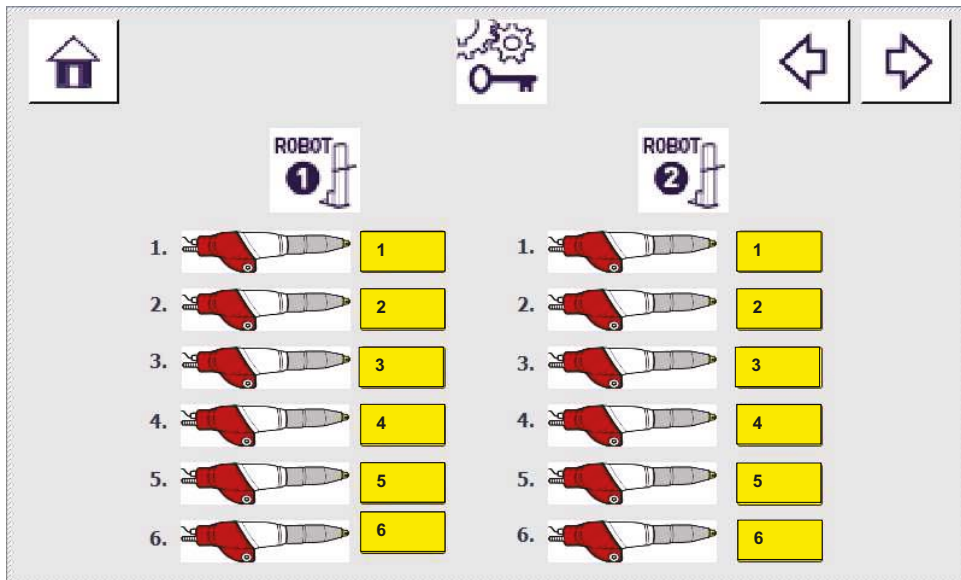

DES06325

Each robot can handle up to 6 projectors powder.

A spray zone - which is defined in the setting of cell barrier of up to 6 zones - is assigned to each sprayer.

6.6. Configuration of conveyor speed

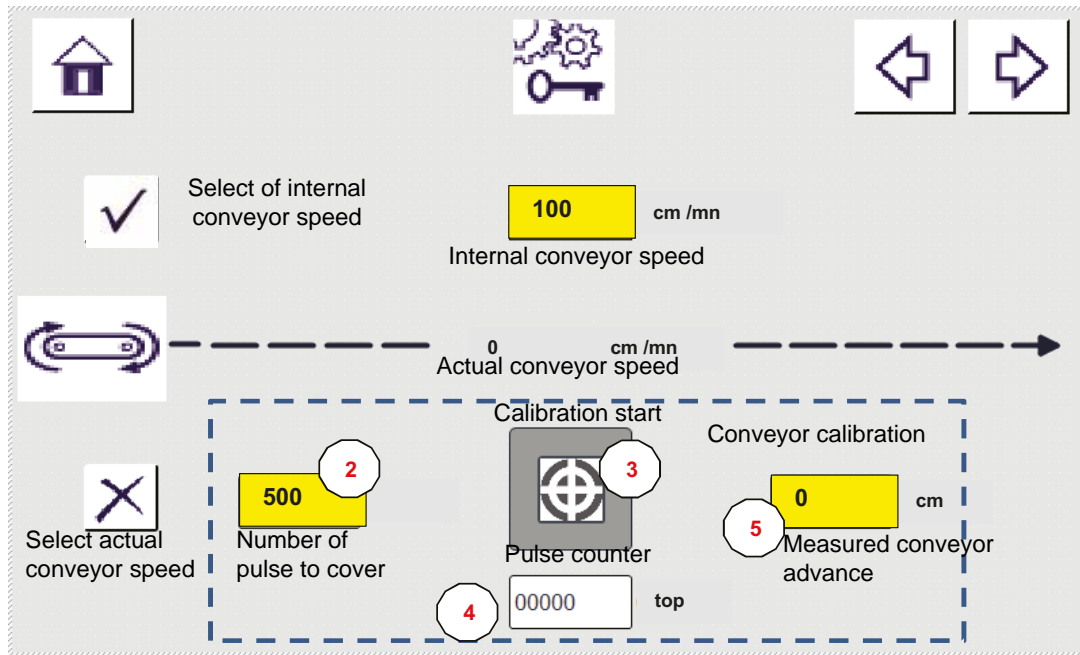

In **internal speed**, the conveyor speed can be simulated by the REV800, it is changeable by the operator.

In **actual speed**, the actual speed of the conveyor is read by the module on the input provided for this purpose (conveyor pulse input).

Note: the internal speed must be disabled to activate the actual speed

For actual speed, it is necessary to achieve first a conveyor calibration.

- **Step 1:** Make a mark between a fixed point and a point of the conveyor.
- **Step 2:** Enter the number of pulses that must cover the conveyor for calibration (Minimum 500 pulses, because it is recommended to have at least a resolution of 1 pulse per cm and the calibration must be made for a minimum of 5 m conveyor advance).
- **Step 3:** Turn the button of calibration start.
- **Step 4:** Move the conveyor until the pulse counter has reached its expected value. The controller automatically stops the conveyor.
- **Step 5:** Measure and enter the actual conveyor advance.

6.7. Advanced Spraying Advanced spraying view

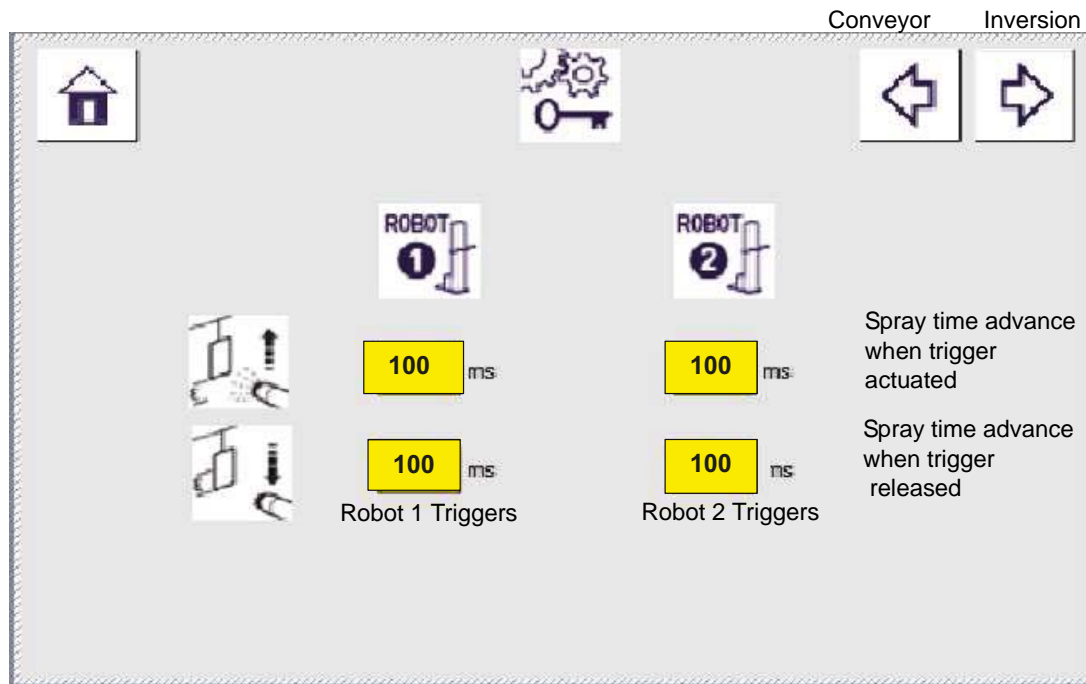

Spray time advance when trigger actuated: The amount of time to advance the start of spraying is calculated on the basis of a specified time and the time taken for the valve to open and product to arrive at the nozzle after the command. The spray command is issued in advance in order to compensate for the delay in opening the valve and the arrival of the product at the nozzle.

Advance distance = Current speed x Advance time

Spray time advance when trigger released: The amount of time to advance the end of spraying is calculated on the basis of a specified time and the time taken for the valve to close after the command. The shut-off command is issued in advance in order to compensate for the delay in closing the valve. This may be different from the actuate time. This time could be negative in order to have a closing delay rather than an anticipation.

6.8. Configuration of the Inputs

"View of the input configuration":

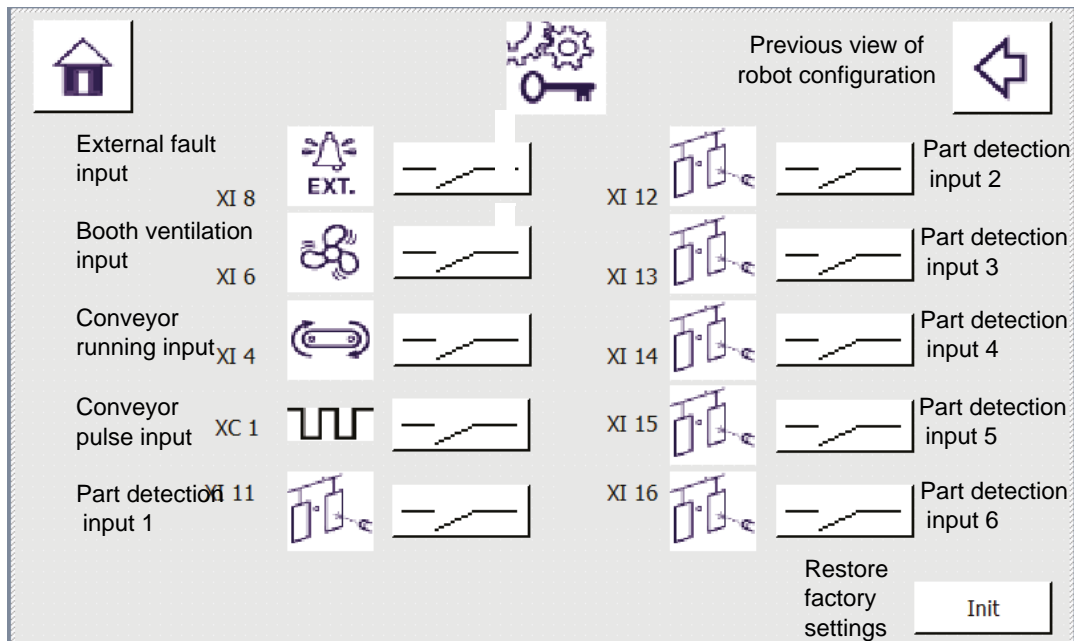

Contact status: The status of the button must correspond to the type de contact connected to the REV 800.

 Normally open contact:

 Normally closed contact:

External fault input: This input accepts data from an external system or modules also involved in the process. The input is on terminal strip XI Pin N°8.

An example of the use of this input would be to incorporate a high voltage fault condition from a powdering module

Booth ventilation input: This input accepts booth ventilation data from the booth cabinet on terminal strip XI Pin N°6.

Conveyor running input: This input accepts conveyor running data from the conveyor cabinet on terminal strip XI Pin N°4.

Pulse conveyor input: This input accepts a pulse conveyor information given by the conveyor cabinet on terminal strip XC Pin N°3.

Parts detection inputs: (1 to 6) These inputs accept data from detection sensors on terminal strip XI Pin N°11 to N°16

Restore factory settings: If an incorrect parameter is entered, it is possible to restore the factory settings by touching this button.

Init

Confirmation of restoration of factory settings view

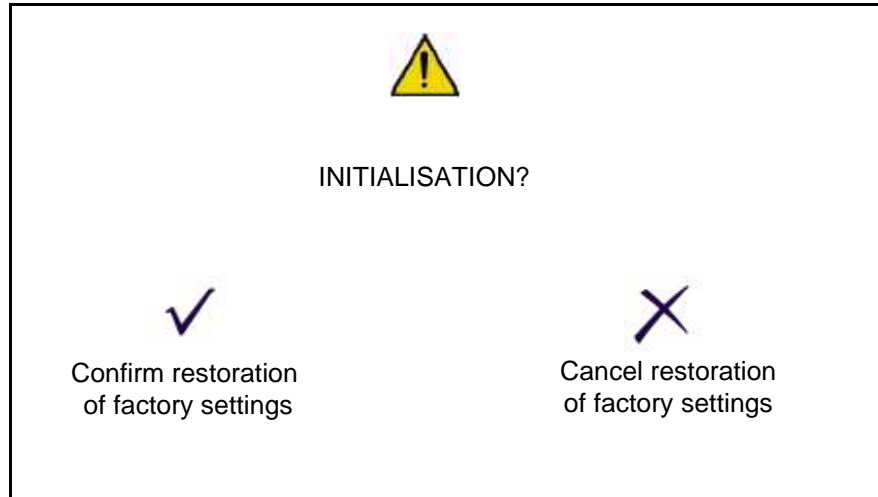

If the operator confirms the restoration of factory settings, the following data is reinitialized:

- Parameters
- Calibration
- Spray tables

7. System Configuration

System configuration view:

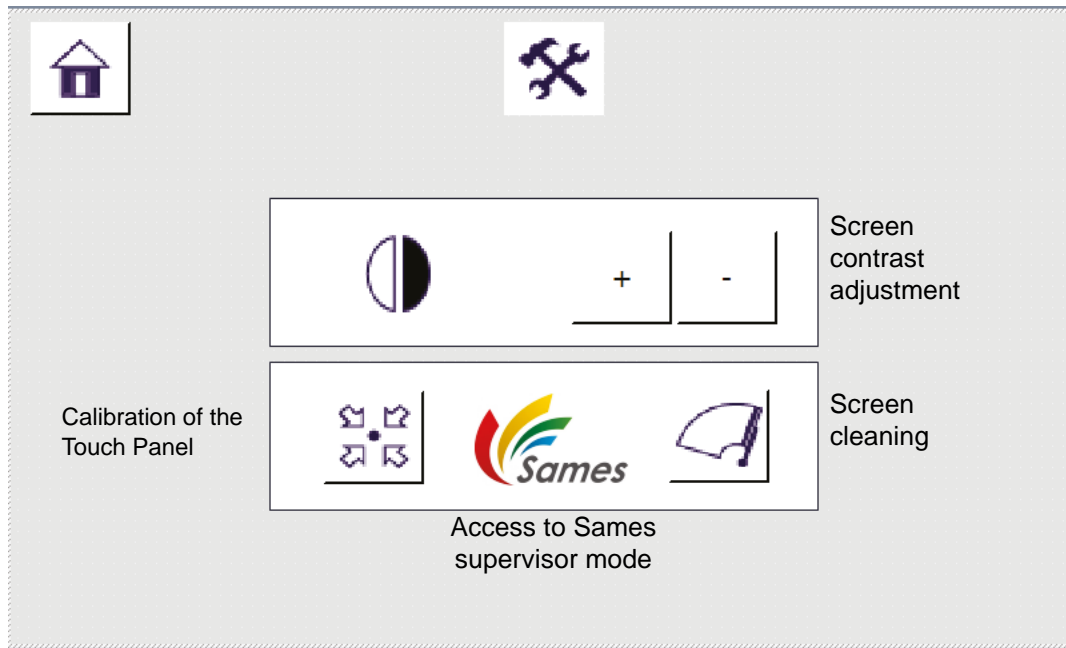

Screen contrast adjustment: Touching the + or – key increases or reduces the screen contrast.

Calibration of the Touch Panel: Touching this key initiates a system procedure for calibrating the Touch Panel to suit the finger pressure of the operator.

Screen cleaning: Touching this key initiates a system procedure to disable the Touch Panel for a period of 20 seconds so that the screen can be cleaned.

Access to Sames supervisor mode: Access to this mode is protected by a password. It is used during construction and repair of the module.

8. Faults and Status

Faults and status view

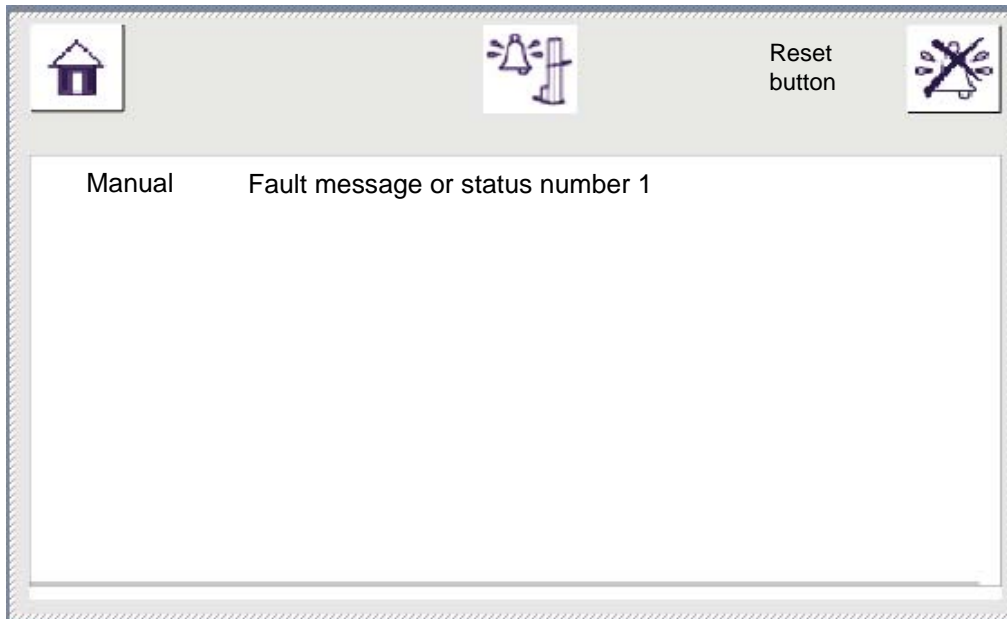

DES06330

This view displays current fault conditions or the status of the system.















It is possible to display up to ten fault or status messages.















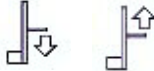

Reset button : This button is used to initiate a reset procedure in the module. If the fault persists, this is an indication that the system requires repair.

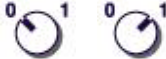
Summary faults and status table

Stop	No power to REV (circuit breaker switch off or emergency stop actuated or validation power button not activated or thermal sensor failure)	
Manual	The system is ready for use. Access to Manual mode is possible.	
Automatic	At least one of the two robots is in automatic mode.	
Thermal probe fault	One of two robots triggered the thermal probe. Wait until the engine cools down	
No conveyor	One or both robots are in automatic mode. They are ready to begin spraying but the REV800 is not receiving the Conveyor running signal. This is a contact across pins 3 and 4.	
Fault in speed converter 1	Current fault condition in speed converter 1.	Switch off the main switch for 30 seconds, then switch on again.
Fault in speed converter 2	Current fault condition in speed converter 2	
Ventilation fault	The ventilation system is not operating. Incorrect configuration (if the fault occurs during commissioning).	Restore the ventilation system to use. Invert the polarity of the contact.
External fault	An external fault is present Incorrect configuration of contact XI (if the fault occurs during commissioning)	Clear the fault Invert the polarity of the contact.
Control fault on axis 1	The robot transmission is faulty. The potentiometer is faulty.	Repair the transmission and recalibrate the robot. Change the potentiometer and recalibrate the robot.
Control fault on axis 2	The speed converter is not being driven correctly.	
Calibration fault on robot 1	Out-of-range value entered.	Enter valid data. (Max. > Min.)
Calibration fault on robot 2		

9. Appendices

Function selected	✓
Function deselected	✗
Increase a value	↑
Decrease a value	↓
Program spray tables	
Manual mode	
Robot configuration	
Automatic mode / Run oscillation	
Robot N°	
Spraying	
Start plan distance	
Upstream/downstream part width	
Menu navigation	
Run / stop oscillation	
Save	
Advance operation	
Return to the Main Menu	
Start of cycle position	

Input polarity	
Booth ventilation	
Conveyor running Conveyor speed	
Parts detection	
External fault	
Reset fault	
Enter / confirm	
Robot movement	
Free axis	
Select robot in manual mode	
Copy table from robot N°1 to robot N°2	
Operating time	
Anticipation spraying	
Part detection by barrier	
Large stroke application	
Short stroke application	
Contrast	
Calibration of Touch Panel	
Screen cleaning	